

**High quality Duradecor surface
with maximum impact resistance**

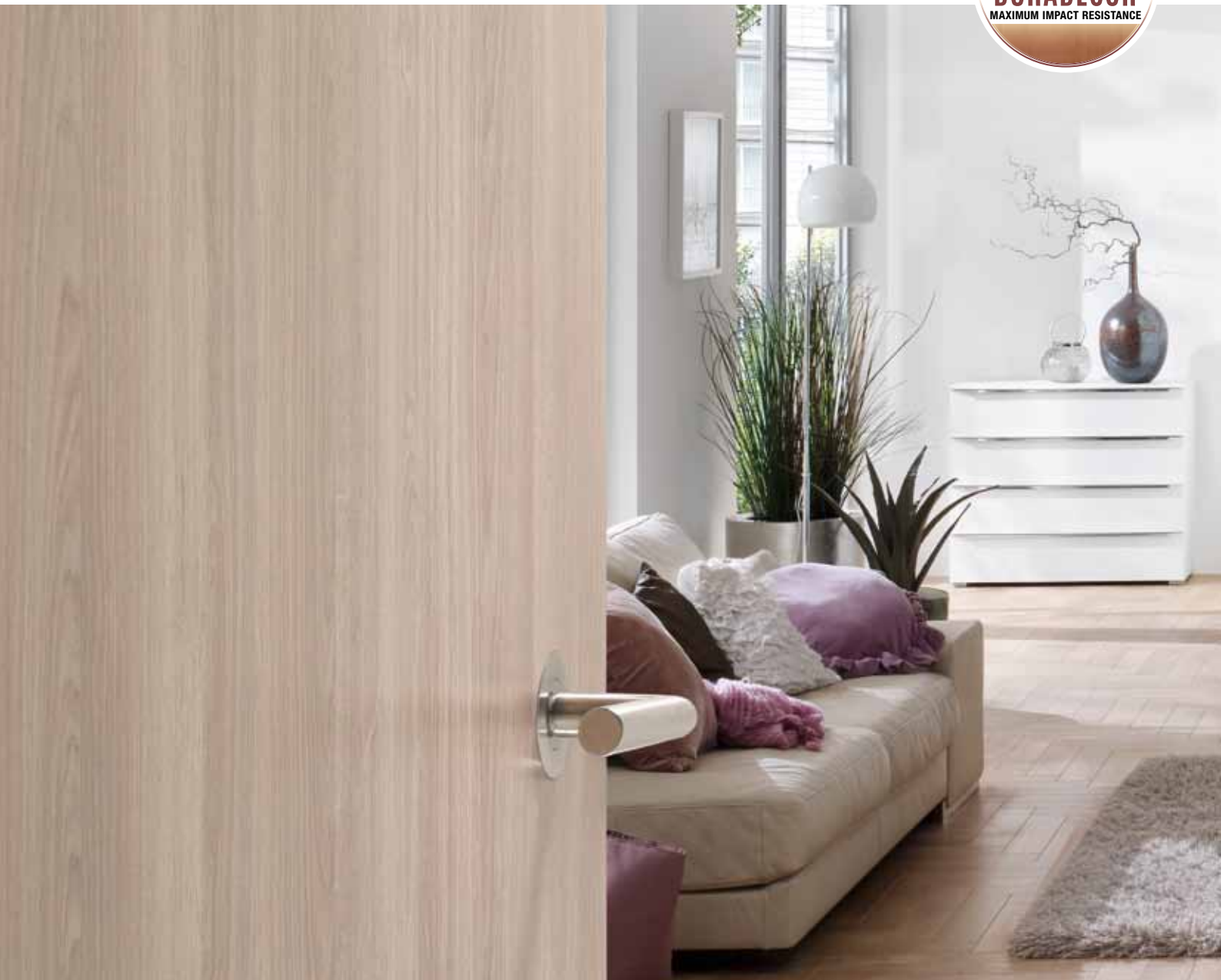

Timber Internal Doors

Exclusive new door styles from Europe's number one provider
of construction elements







Good reasons for a timber internal door from Hörmann	6
BaseLine	10
BaseLine Duradecor	12
BaseLine Duradecor synchronous texture	18
BaseLine Duradecor texture	20
BaseLine real wood veneer	22
Baseline Lacquer	24
DesignLine	26
DesignLine Steel / Plain	28
DesignLine Inlay / Rail	36
DesignLine Groove / Rail	42
DesignLine Georgia	46
DesignLine Vermont	54
DesignLine Carolina	58
TechnicLine	63
GlassLine	67
Glazings	69
Glazing cut-outs / side elements / transom lights	70
Door leaf versions	72
Panelled versions	74
Sliding door versions	77
Lever handle sets	78
Handles for sliding doors / fittings for all-glass doors	80
Surface finishes	82
Overview table	86
Technical data	88

Some of the doors shown are equipped with optional extras and do not always correspond to the standard models. The surface finishes and colours shown are subject to the limitations of the printing process and cannot be regarded as binding. All colours based on RAL. All rights reserved. No part may be reproduced without our prior permission. Subject to changes.

Discover a new feeling of home: high quality timber internal doors

Our home is the centre of our life, our safe haven, our oasis of well-being.

As a family business, this spurs us on to provide products made in Germany to give you that special feeling of being at home. Our high quality timber internal doors contribute to this and provide your home with that extra cosy feeling.

Whether classic or modern, white lacquer or beech, with glass elements or stainless steel embellishments – Hörmann offers you the timber internal door that suits you and your furnishings perfectly.



Made in Germany





Good reasons for a timber internal door from Hörmann



1

Door leaf and frame versions

With a timber internal door from Hörmann, you are literally choosing a “door for life.” Our uncompromising quality assurance guarantees you a product with a long service life. See for yourself the many advantages of our high quality timber internal doors and discover the various door and frame versions as well as the different surfaces available on the next pages.

Custom combinations:

A rebated door leaf with rounded edges and a frame with rounded edges create a harmonious Softline look **1**. The same combination with angular edges results in clear lines (no image). The flush-closing door leaf and a frame with angular edges give your door a practically flush-fitting appearance **2**.



High quality door leaf

Available with four different door leaf inserts – from a simple honeycomb insert up to a high-quality solid chipboard.

Sturdy timber frame:

Consists of an extra sturdy 25-mm-thick jamb lining. Particularly robust MDF boards give the decorative edges and rebate cladding a smooth surface.

Robust steel frame:

An alternative to the timber frame: the robust steel frame **3**. Thanks to a special final coating, the colour surface is particularly resistant.



2

Extremely impact-resistant: Duradecor surface

The high quality surface will delight you: Duradecor captivates due to features such as heat resistance, robustness and impact resistance, which combine to ensure a long service life.



3

See and touch: Duradecor texture

The finely textured surfaces allow you to feel what you see. A wood grain texture is embossed into the door leaf, making the characteristic wood structure of the Duradecor texture surface tangible. In the synchronous texture, the wood grain matches the printed surface finish exactly.



4

High-class and smooth:
painted surface finishes

Timber internal doors with white painted surfaces have an especially classic and high-quality effect. The Hörmann paint coating on a white base plate ensures a uniform surface with a rich, vibrant colour.

5

All natural:
real wood veneer

Hörmann real wood veneers are produced from high-quality real timber and are truly unique. An environmentally-friendly protective paint ensures that you can enjoy your real wood door for a long time.



Plain, chic, timeless: BaseLine

Would you like a timelessly elegant internal door with a welcoming character for your home? Then the door models in the BaseLine series offer you the perfect selection. The solid door leaf in a flush or rebated version – combined with your preferred surface – harmonises wonderfully with your style. This allows you to create a comfortable and relaxing atmosphere.



Subtle elegance with a simple
and homelike effect

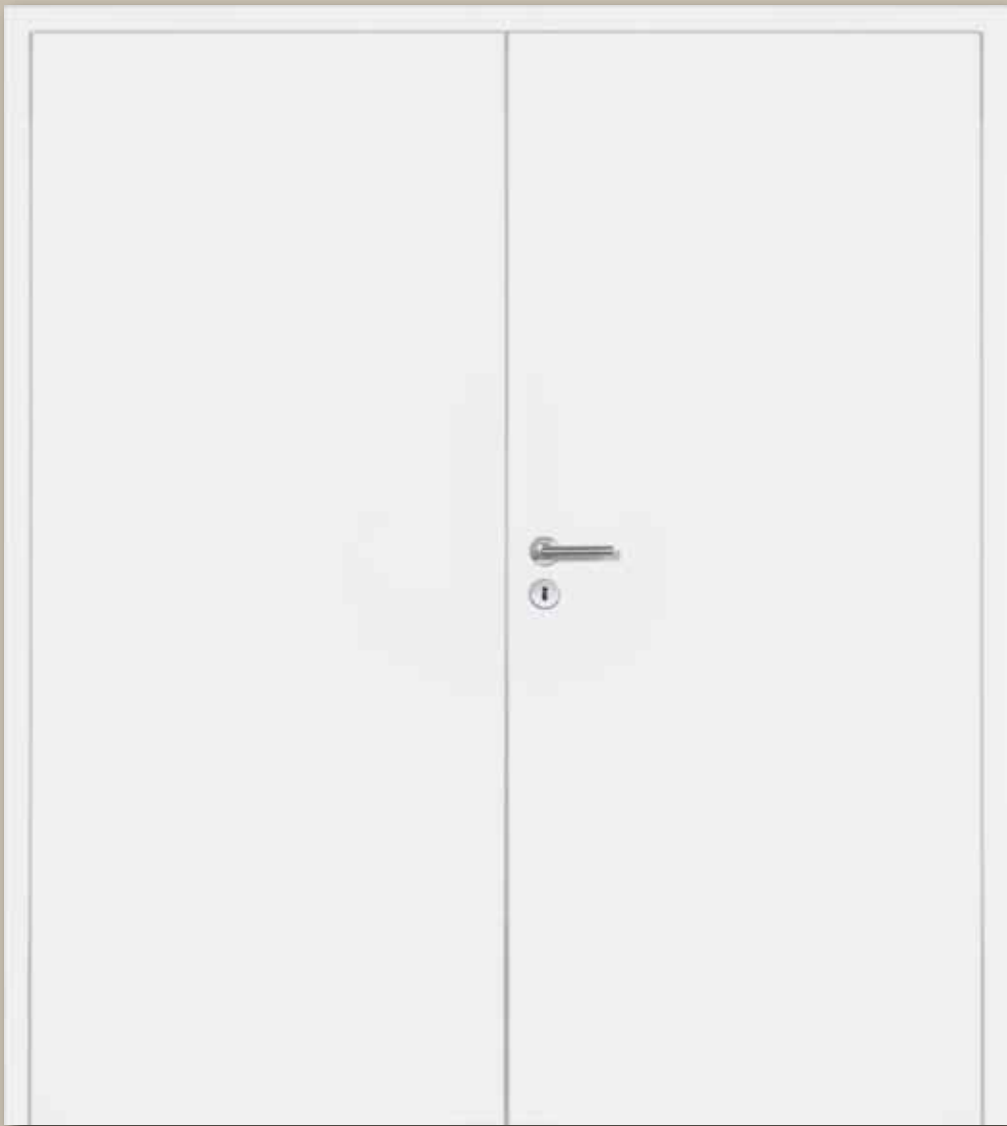

BaseLine
Duradecor Traffic white RAL 9016, double-leaf
Flush version with concealed hinges



BaseLine
Duradecor White Parchment
with glazing cut-out LA 9
Rebated version



BaseLine
Duradecor White Ash
Rebated version



As beautiful as nature,
perfect for your home



BaseLine
Duradecor Grey Oak
Rebated version

Simple elegance that guarantees cosiness



BaseLine
Duradecor Italian Acacia
Flush version



BaseLine
Duradecor Canadian Maple
with glazing cut-out DIN
Rebated version



BaseLine
Duradecor French Beech
Rebated version



BaseLine
Duradecor White Oak
with glazing cut-out LA 2
Rebated version



Experience the attention to detail



BaseLine
Duradecor synchronous texture
Basalt Oak
Flush version



BaseLine
Duradecor synchronous texture
Quartz Oak
Flush version



BaseLine
Duradecor synchronous texture
Fire Oak
Flush version



Authenticity for your home



BaseLine
Duradecor texture Wild Oak
Rebated version



BaseLine
Duradecor texture Raw Oak
Rebated version

The fascination of real wood veneer –
natural and cosy



BaseLine
Real wood veneer Beech
Rebated version



BaseLine
Real wood veneer White Oak
Rebated version



BaseLine
Real wood veneer Maple
with glazing cut-out LA 5
Rebated version

Simply live elegantly



BaseLine
White lacquer
Rebated version





Discover your dream door: DesignLine

Create the door of your dreams with DesignLine. Upmarket lacquer surfaces, natural real wood veneers and robust Duradecor surfaces in exclusive designs satisfy the highest demands when it comes to style. Whether you choose a rebated or flush door leaf or style elements like surface-mounted embellishments or recessed grooves, the DesignLine models allow you to attractively outfit your home according to your taste.





Plain 27-7
Duradecor Traffic white RAL 9016
Rebated version



Steel 14
Duradecor Traffic white RAL 9016
Flush version with concealed hinges

We are dedicated to detail

Subtle embellishments transform your timber internal door into a stylish eye-catcher and satisfy the highest design demands.

For the style Plain 27-7, embellishments with a brushed matt stainless steel look are inlaid flush-fitting in the door leaf, creating an elegant contrast.

Surface-mounted embellishments in stainless steel on the door leaf give the Steel styles timelessly elegant contours that fascinate design fans.

The Steel styles and the style Plain 27-7 are available in all decors of the extremely impact-resistant Duradecor* surface.



Flush-fitting inlaid embellishment in stainless steel look for the style Plain 27-7



Surface-mounted aluminium embellishment for the Steel styles

Special elements to add style to everyday life



Steel 27
Duradecor Traffic white RAL 9016
Rebated version



Rail 1
Duradecor White Parchment
Design glass 2 with matt sections
Rebated version



Steel 20
Duradecor Traffic white RAL 9016
Rebated version



Rail 2
Duradecor White Ash
Satinato glass
Rebated version





Plain 27-7
Duradecor Italian Acacia
Flush version



Steel 14
Duradecor Grey Oak
Flush version with concealed hinges

Matching combinations that exude warmth



Steel 20
Duradecor French Beech
Rebated version



Rail 2
Duradecor French Beech
Satinato glass
Rebated version



Steel 27
Duradecor Canadian Maple
Rebated version



Rail 1
Duradecor White Oak
Design glass 2 with matt sections
Rebated version



Inlay 26
Real wood veneer Beech
Flush version

Harmonious combinations

A small detail with a major effect: the inlaid pilaster strips in Maple or Beech are the highlight of the door style Inlay 26. They fit flush to the door leaf, resulting in a harmonious overall view. The styles Inlay 2 and Inlay 12 in alternating grain patterns provide the door leaf with a unique look. All Inlay styles are available in the real wood veneers Maple, Beech and White Oak.



Inlaid pilaster strips in the door style Inlay 26



Experience the cosy character of wood
at its best



Inlay 2
Real wood veneer White Oak
Rebated version



Rail 1
Real wood veneer White Oak
Satinato glass
Rebated version



Inlay 12
Real wood veneer Maple
Flush version with concealed hinges



Rail 2
Real wood veneer Maple
Design glass 2 with matt sections
Rebated version





Groove 15
White lacquer
Rebated version

The icing on the cake

Recessed grooves are the special feature of the Groove door styles. They are painstakingly milled in the door leaf and then coated with high-quality paint. This results in elegant door styles with white surfaces that are a highlight in any room.

The door leaf version with rounded edges showcases the grooves in a particularly elegant manner.

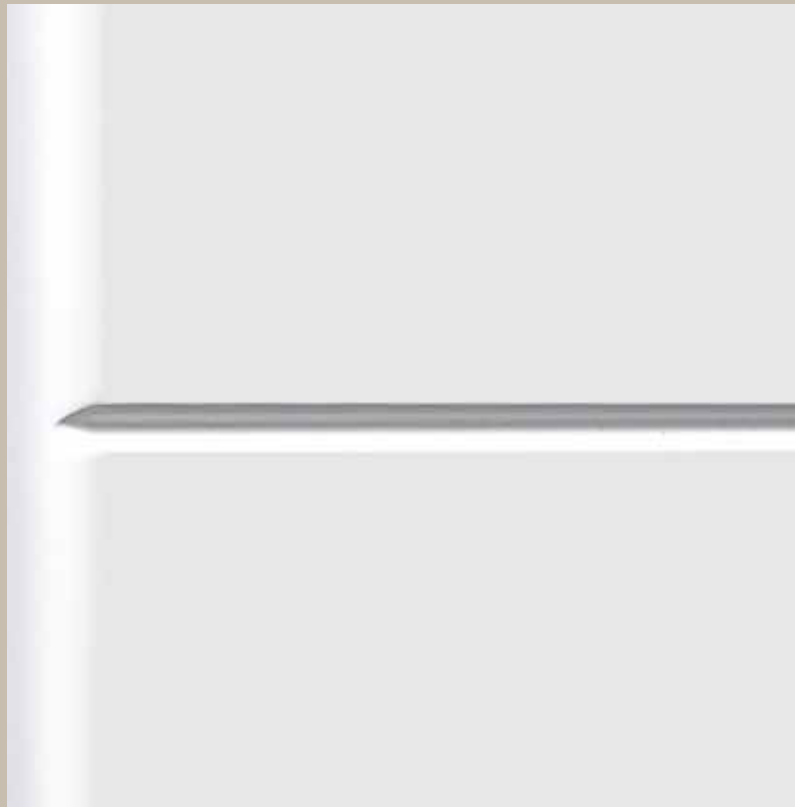

Recessed grooves in the Groove door styles

Our designer items for a more beautiful home



Groove 13
White lacquer
Rebated version



Rail 1
White lacquer
Design glass 2 with matt sections
Rebated version



Groove 20
White lacquer
Rebated version



Rail 2
White lacquer
Satinato glass
Rebated version



High-quality details, elegant appearance

For the perfect country look, we recommend the exclusive Georgia door styles. The high-quality profile strip is inlaid into grooves in the door frame using traditional carpentry techniques, lending these styles an elegant appearance. The Georgia door styles are available in all Duradecor*, real wood veneer and lacquer surfaces.



Inlaid profile strip for the Georgia door styles.
For more information, see pages 74 – 75.

* Except for Duradecor texture and synchronous texture



Georgia 1
Duradecor Traffic white RAL 9016
with glazing cut-out
Rebated version

Traditional styles lend your home
a classic charm



Georgia 2
Duradecor Traffic white RAL 9016
Rebated version



Georgia 4
Duradecor White Ash
Rebated version

Add a bit of country life to your apartment



Georgia 1
Duradecor French Beech
Rebated version



Georgia 2
Duradecor Italian Acacia
Rebated version



Georgia 4
Duradecor Canadian Maple
Rebated version



Experience wood in a classic look



Georgia 1
Real wood veneer Beech
Rebated version



Georgia 2
Real wood veneer White Oak
Rebated version



Georgia 4
Real wood veneer Maple
Rebated version



Georgia 1
White lacquer
Rebated version



Georgia 2
White lacquer
Rebated version



Georgia 4
White lacquer
with glazing cut-out
Rebated version



Decorative contrast for more cosiness

The Vermont door styles radiate classic elegance. They are characterised by a profile strip that is surface-mounted on the smooth door leaf, creating a comfortable contrast. These door styles are available in all Duradecor* designs.



Surface-mounted profile strip for the Vermont door styles.
For more information, see pages 74 – 75.

* Except for Duradecor texture and synchronous texture

Experience personalised country house chic



Vermont 1
Duradecor Traffic white RAL 9016
Rebated version



Vermont 2
Duradecor Traffic white RAL 9016
Rebated version



Vermont 4
Duradecor White Ash
Rebated version



Vermont 1
Duradecor Grey Oak
Rebated version



Vermont 2
Duradecor Italian Acacia
Rebated version



Vermont 4
Duradecor White Oak
Rebated version



Beauty that is more than skin deep

The Carolina doors have a clean, classic look. The panel frames are created by an embossed profile in the door leaf. A paint coating on a white base plate gives the styles a smooth, brilliant colour surface.

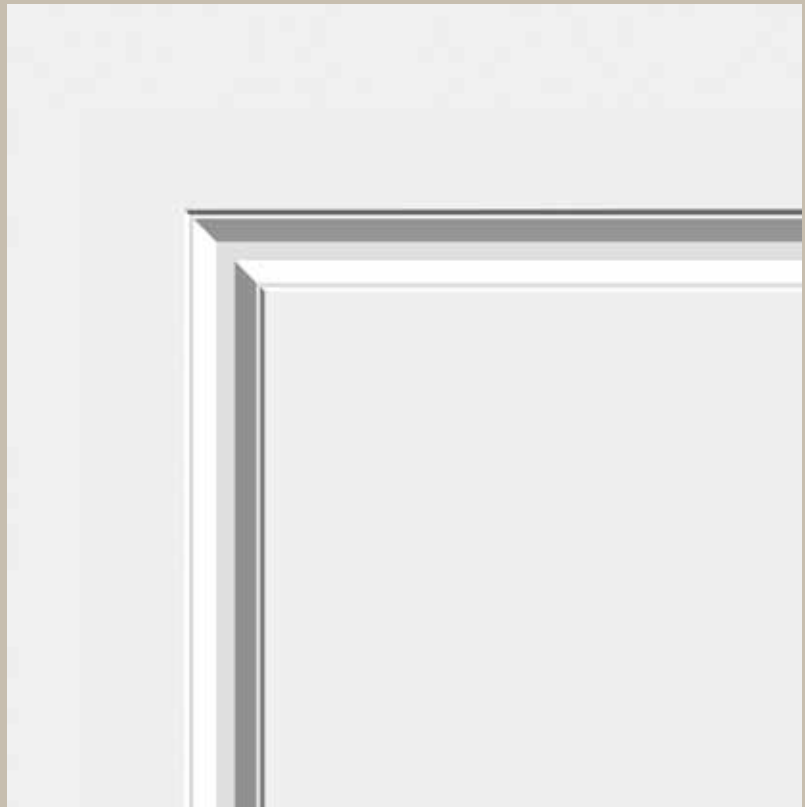

Embossed profile for the Carolina door styles.
For more information, see pages 74 – 75.

For everyone who loves the classics



Carolina 1
White lacquer
Rebated version



Carolina 2
White lacquer
Rebated version



Carolina 4
White lacquer
Rebated version



A feeling of security for you and your family

Almost all BaseLine and DesignLine styles are available as apartment entrance doors, and as TechnicLine styles with specialised equipment (e.g. LCD display). The doors are equipped with climatic class 3 and acoustic rating category II as standard. This way, they offer protection against noise and cold from outside. Optionally, all doors from the TechnicLine are available with RC 2 security equipment and other special features – for a feeling of complete safety when you go to bed at night.





Your safe apartment entrance door

TechnicLine is available without glazing cut-out in BaseLine and the following versions of DesignLine: Steel, Plain, Groove, Inlay, Georgia (with contour-milled profile strip) and Vermont.

Standard equipment

- Climatic class 3
- Acoustic rating category II



Retractable bottom seal as standard



Optional VX hinge for increased security

Optional security equipment RC 2 for apartment entrance doors

- VX hinge
- 3-point locking with stainless steel lock cover
- Reinforced leaf frame

Optional equipment

- Spyhole
- Wide angle camera with LCD display (figure on page 64)
- Electric strike
- Motor lock



Additional locking at top in the optional RC 2 security version



Protective fitting ES 2 for optional RC 2 security equipment



Additional locking at bottom in the optional RC 2 security version



For a friendly atmosphere: all-glass doors

Glass doors are not only upmarket and chic, they contribute to an open and friendly design for your home and lend each room a particular charm.

Discover the all-glass door that suits you. Available as leaf doors with timber frame or as sliding doors (for more information on sliding door versions, see pages 76 – 77).



Matt sections and clear lines for design glass 2



All-glass door with frame in Duradecor Traffic white RAL 9016
Design glass 2



All-glass door with frame in real wood veneer White Oak
Design glass 1

Glass elements according to your specifications

You can choose from five different types of glazing to individually design your internal door.

Every glazing style is available for all-glass doors, for all Rail series styles and for all doors with glazing cut-outs. You can customise your internal door with elegant glass elements according to your taste.



Clear glass

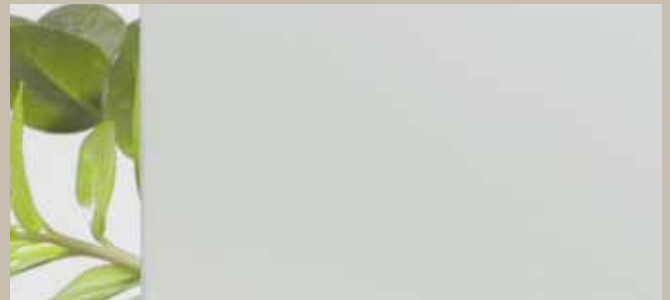

Satinato glass



Mastercarré glass



Design glass 1 with matt lines and clear sections



Design glass 2 with matt sections and clear lines

How to customise your dream door

Glazing cut-outs

With our selection of glazing cut-outs, you can take your favourite style and make the personalised door of your dreams. You can select the glazing style for your glazing cut-out – you can find all glazing variants on page 69.

Side elements and transom lights

Side elements and transom lights flood your living spaces with light for a special flair. While side elements visually enhance the door sets, transom lights emphasise the room height. Top panels underscore the ceiling-high appearance of the door set.



Glazing cut-outs

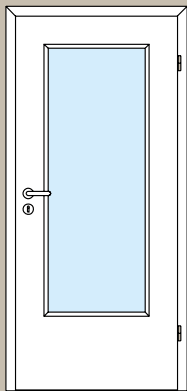

Handing

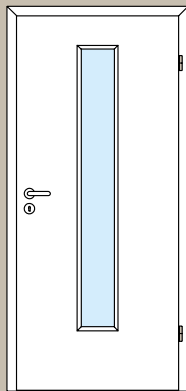

LA2 centre

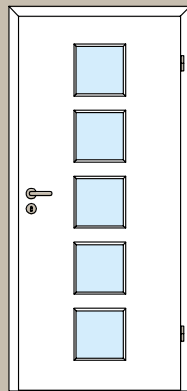

LA 5

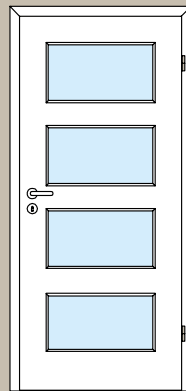

LA 9

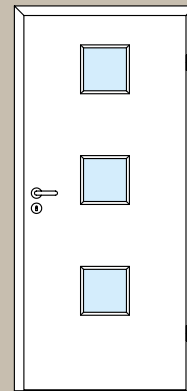

LA 10

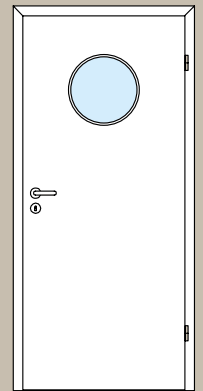

Round glazing

All door styles in the DesignLines Georgia, Vermont and Carolina are available with glazing in the upper panels.

Side elements

(intel-high)

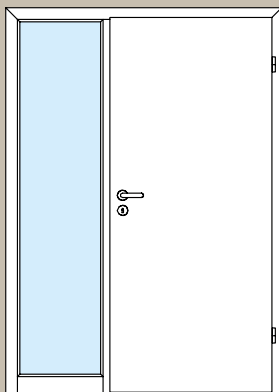

Single-leaf with 1 side element

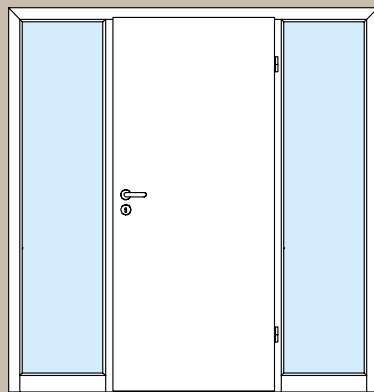

Single-leaf, 2 side elements

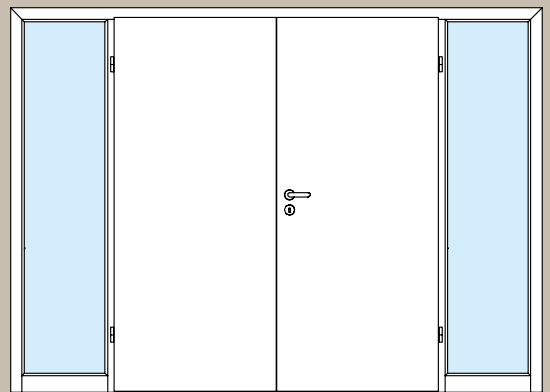

Double-leaf, 2 side elements

Transom lights

(ceiling-high)

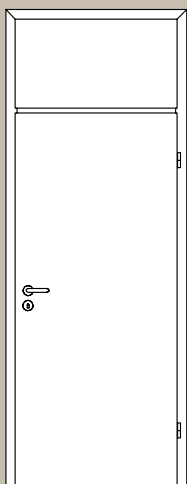

Single-leaf, 1 transom light

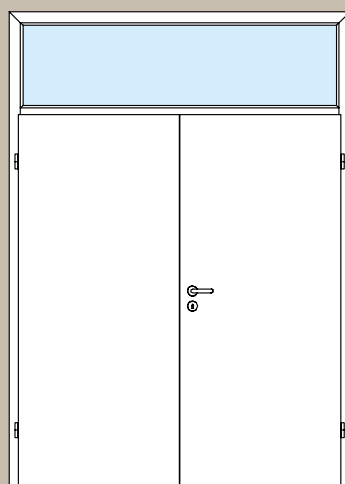

Double-leaf, 1 transom light

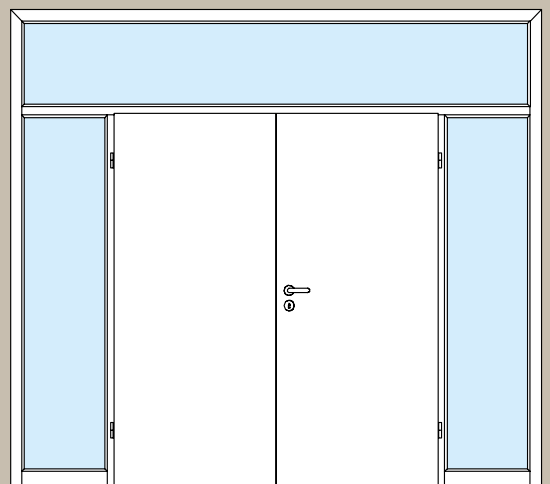

Double-leaf, 2 side elements, 1 transom light



Flush version

The flush closing door leaf offers an exclusive door appearance with a practically seamless transition to the frame and emphasises modern home design.

Hinges



Guide roller
V 7888 WF 3D
(as standard)



Concealed 3D hinge
(optional)

Lock



Standard: deadlock,
Class I, lock cover
in nickel silver



Optional: magnetic
latch lock



Rebated version

The rebated version is available in two edge versions. The version with angular edges (no image) creates clear contours while the rebated door leaf with rounded edges provides a harmonic Softline look.

Hinges



Guide roller V 3420 WF (as standard)



Guide roller V 4426 WF (as standard from 985 mm door width for tubular chipboard insert)

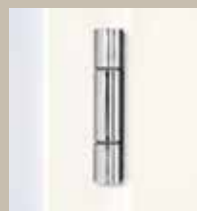

3D hinge VX 100-18 (optional)



Concealed hinge Pivota FX 2 60 3D (optional)

Lock



Standard: deadlock, Class I, lock cover in nickel silver

Our panelled versions in detail Georgia – with inlaid profile strip

Our panelled doors emphasise a perfect country house style. Whether with a Duradecor surface, in a lacquered version, or as real wood veneer – each individual door satisfies the demands for a tasteful and comfortable home.

You have a choice of styles with intricately inlaid profile strip, classic surface-mounted profile strip or embossed profile.

During production of the high-quality Georgia door styles, a groove is milled with great care and a profile strip is inlaid in it. This creates a sophisticated door appearance. Georgia is available in all Duradecor*, real wood veneer and lacquer surfaces and decors.



Vermont – with surface-mounted profile strip

The surface-mounted profile strip characterises the classic lines of the Vermont door styles. We provide these styles in all the Duradecor* surface designs.



Carolina – with embossed profile

In the Carolina styles, the profile is embossed directly into the door leaf and then carefully painted. The Carolina series is available with a white lacquer surface.



Our space-saving marvels: sliding doors

Sliding doors open up new possibilities for ideal use of your living space. Hörmann offers sliding door solutions for every living situation. All rebated door styles in BaseLine and DesignLine as well as in GlassLine are available as sliding doors.



With the brush on the door leaf (figure on left) and the inlet seal in the frame (figure on right), Hörmann sliding doors offer optimal protection against odours, noise and draughts – for even more comfort in your own home.

Sliding door box type A, double-leaf



Running in front of the wall: frame, guide rail panelling and door leaf form a harmonious unit



Running within the wall: door leaf is inserted on-site into a door pocket in the wall, the frame completely conceals the wall opening

**Sliding door box type C,
single-leaf**



Running in front of the wall,
opening towards the left

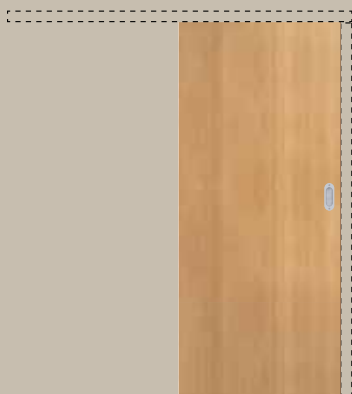

Running within the wall,
opening towards the left

**AluTec rail,
single and double-leaf**



Running in front of the wall,
opening towards the left

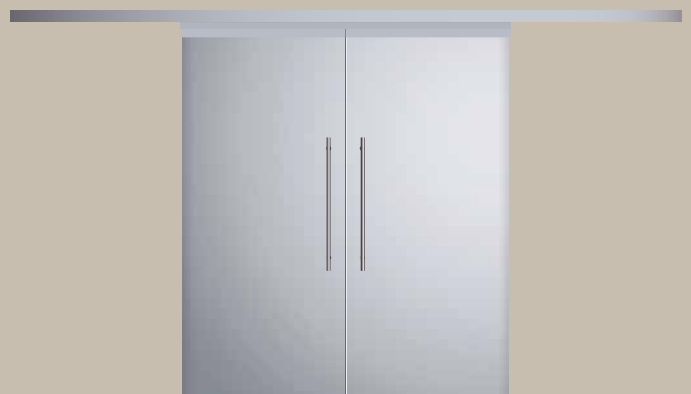

Running in front of the wall



AluTec rail with timber door

Handle sets to suit every taste

Whether classic or modern, angular or rounded – Hörmann offers you a wide range of elegant and high-quality lever handle sets for the BaseLine, DesignLine and TechnicLine door models.

Handles for door leaves



Ala
Brushed matt stainless steel



Contra
Brushed matt stainless steel

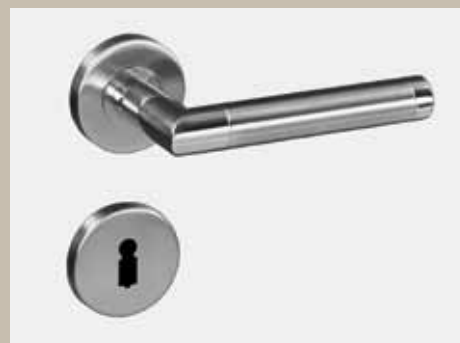

Senso
Brushed matt stainless steel



Arundo
Brushed matt stainless steel



For an especially elegant door appearance, all lever handles are optionally available in a flush-fitting Planar variant.

The pictured handles are optionally available in the following versions



Linea
Brushed matt stainless steel



PC handle set
(cylinder optional)



Deadlock handle set

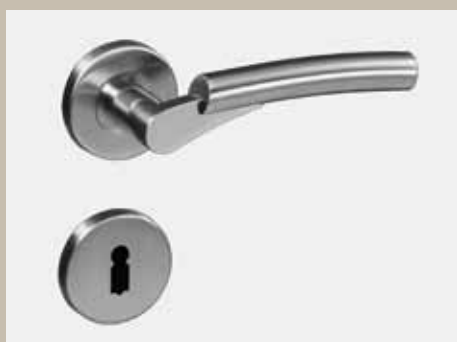

Tento
Brushed matt stainless steel



WC handle set



Deadlock lever / knob handle
set with door knob

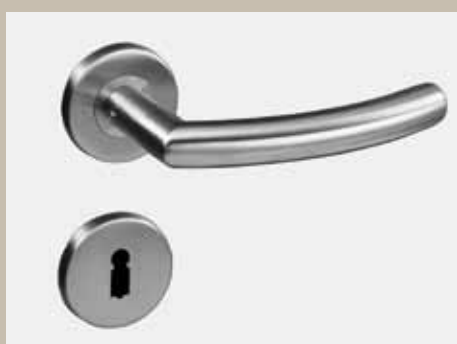

Vallis
Brushed matt stainless steel

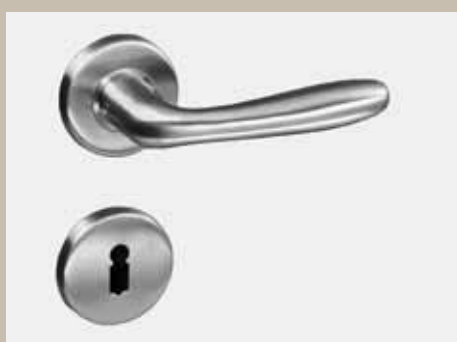

Vento
Brushed matt stainless steel

Beautifully shaped handles that are simply impressive

Handles for sliding doors

Personalise your sliding door with the handle of your choice. We offer handles for glass doors and timber doors that tastefully complete the look of your sliding door.



For sliding doors that run within the wall, you can conceal the door leaf completely in the wall with a trip handle. The handle springs out at the press of a button, allowing you to close the door.

Handles for sliding doors



FSB 4212
(for timber doors)



FSB 4250
(for timber doors)



FSB 4251
(for timber doors)



Push bar 400
(for timber and glass doors)



FSB 4252
(for timber doors)



FSB 4253
(for timber doors)



LM 200
(for glass doors)



GM 5905
(for glass doors)

Fittings for all-glass doors

For all-glass doors, you can choose between four stylish handles that perfectly match the fittings. Each variant is available in a lockable and non-locking version.



Ala



Contra



Linea



Door hinge Junior, 3-part



Vento

Benefit from impressive performance features: Duradecor



With regard to ease of care and robustness, Duradecor cannot be beaten – it is almost as durable as a kitchen countertop.

- Maximum impact resistance
- Hygienic and low-maintenance
- Strong antistatic and colour-fast properties
- Resistant to heat and abrasion
- Stands up to normal household fluids, pastes, etc.



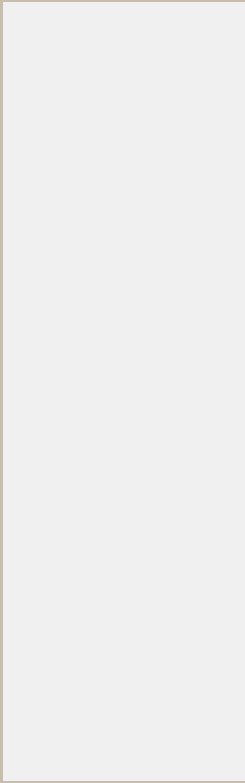

Traffic white
RAL 9016

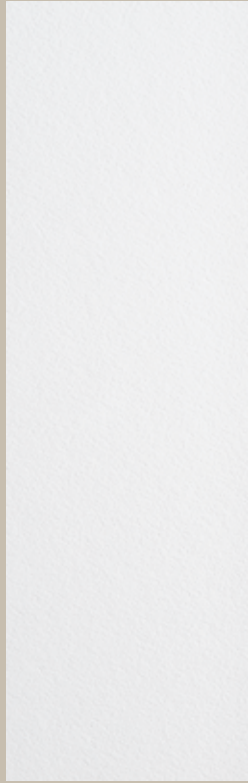

White Parchment



White Ash



Italian Acacia



Italian Acacia,
horizontal



Canadian Maple



French Beech



White Oak



White Oak, horizontal



Grey Oak

Duradecor synchronous texture

With the Duradecor synchronous texture surface finish, we have achieved a perfect visual and tactile reproduction of real timber down to the last detail:

- The characteristic wood grain texture is precisely embossed into the door leaf
- The texture matches the printed design exactly
- A perfect reproduction of real timber that's visible and tangible

Duradecor texture

The Duradecor texture surface has a subtle natural timber character:

- A wood grain texture is embossed into the door leaf, making the characteristic wood structure tangible



Quartz Oak



Basalt Oak



Fire Oak



Wild Oak



Red Oak

Real wood veneer

Just as every tree is different, so too each of our real wood veneers is unique:

- Made of high quality real timber
- Environmentally-friendly protective paint for durable surface protection
- Natural wood grain
- Long-lasting quality

Lacquer

Find out about the high-quality Hörmann lacquer surface finish:

- Smooth surface
- Rich, vibrant colour
- Paint coating on a white base plate



Maple



Beech



White Oak





Lacquer

Door styles



BaseLine	DesignLine Steel	DesignLine Groove	DesignLine Inlay	DesignLine Rail	DesignLine Georgia	DesignLine Vermont	DesignLine Carolina	GlassLine
----------	------------------	-------------------	------------------	-----------------	--------------------	--------------------	---------------------	-----------

Surface finishes



Duradecor

Rebated angular		•	•			•	•	•		
Rebated round		•	•			•	•	•		
Flush angular		•	•			•	•	•		



Duradecor synchronous texture

Rebated angular		•								
Rebated round										
Flush angular		•								



Duradecor texture

Rebated angular		•								
Rebated round										
Flush angular		•								

Real wood veneer

Rebated angular		•			•	•	•			
Rebated round		•			•	•	•			
Flush angular		•			•	•	•			

Lacquer

Rebated angular		•		•		•	•		•	
Rebated round		•		•		•	•		•	
Flush angular		•		•		•	•		•	

Door leaf insert

Honeycomb insert	Tubular chipboard insert	Tubular chipboard plate	Solid chipboard
------------------	--------------------------	-------------------------	-----------------

•		•	•
	•	•	•
		•	•

		•	
		•	

		•	
		•	

	•	•	•
	•	•	•
	•	•	•

		•	•
	•	•	•
	•	•	•



Honeycomb insert

The honeycomb insert retains its shape and has an excellent price-performance ratio.



Tubular chipboard spacers

The door leaf insert consists of individual spacers that are arranged in the best possible layout. This causes the door leaf to be especially sturdy and suitable for heavy wear.



Tubular chipboard plate

The solid plate with horizontal tubes gives door leaves high surface stability. These high-quality internal doors are suitable for even heavier wear.



Solid chipboard

The high-quality solid chipboard door leaves have the highest leaf rigidity and are suitable for especially heavy wear. Doors with glazing cut-outs are available with solid chipboard as standard.

Technical data

Door leaf

- approx. 40 mm thick (TechnicLine approx. 46 mm thick)
- Frame construction made of solid timber/timber material with additional frame reinforcement, can be shortened by 25 mm at bottom
- For double-leaf doors: with counter rebate*
- Climatic class I (TechnicLine Climatic class III)
- Duty category N to E (according to version)
- Pre-hanged according to DIN 18101
- Suited for timber profile frames or standard frames made of steel

Frame

- Rebate cladding 16 × 60 mm, mitred and firmly glued to the jamb lining, 16 × 80 mm on request
- Jamb lining made of 25 mm chipboard, rebate cladding and decorative edge made of 12 MDF boards
- Decorative edge 16 × 60 mm, optionally 16 × 80 mm
- Adjustable for wall thickness – 5 mm / + 15 mm
- Sound-absorbing seal inserted at the factory, mitred

Vertical view

Rebated

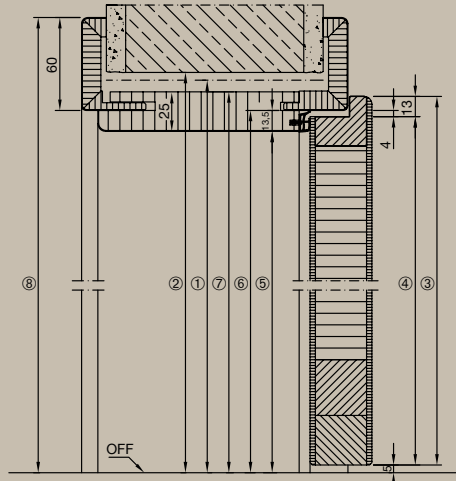

Flush

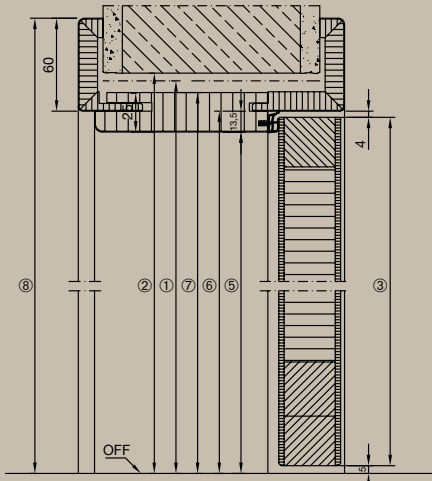

		1875	2000	2125	2250
[1] Nominal size height		1875	2000	2125	2250
[2] Wall opening		1880	2005	2130	2255
[3] Overall door leaf dimension	Rebated	1860	1985	2110	2235
	Flush	1847	1972	2097	2222
[4] Leaf rebate dimension		1847	1972	2097	2222
[5] Clear passage dimension		1843	1968	2093	2218
[6] Frame hold dimension		1856	1981	2106	2231
[7] Overall lining dimension		1868	1993	2118	2243
[8] Overall cladding dimension for 60 mm cladding (for 80 mm cladding + 20 mm)		1916	2041	2166	2291

Frame types

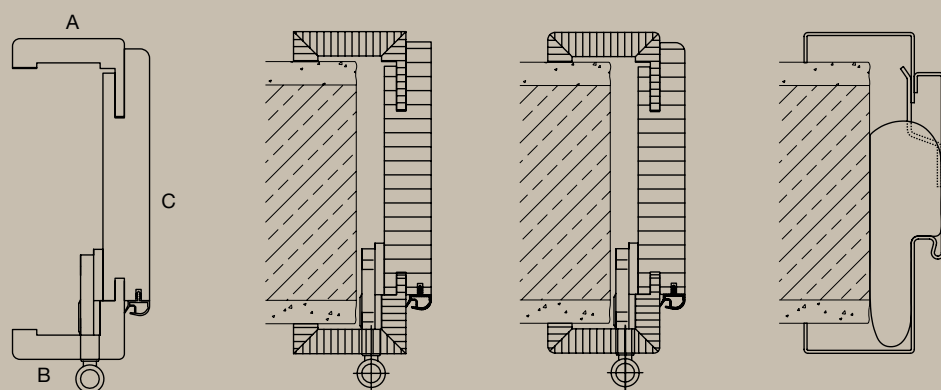

A: Decorative edge
B: Rebate cladding
C: Jamb lining

Timber frame, angular

Timber frame, round edge

Steel frames with wall width adjustment, brickwork

Horizontal view – single leaf

Rebated

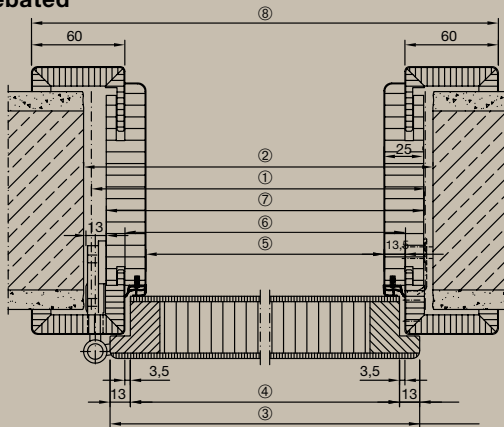

Flush

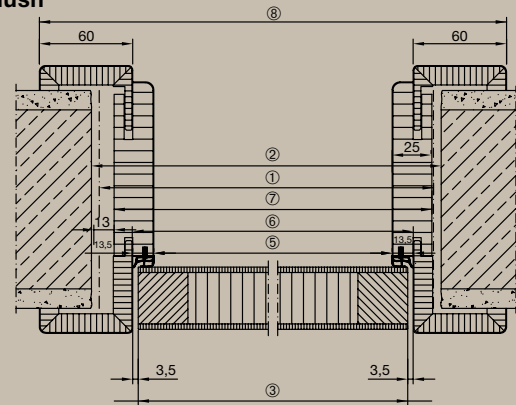

		625	750	875	1000	1125	1250
[1] Nominal size width		625	750	875	1000	1125	1250
[2] Wall opening		635	760	885	1010	1135	1260
[3] Overall door leaf dimension	Rebated	610	735	860	985	1110	1235
	Flush	584	709	834	959	1084	1209
[4] Leaf rebate dimension		584	709	834	959	1084	1209
[5] Clear passage dimension		564	689	814	939	1064	1189
[6] Frame hold dimension		591	716	841	966	1091	1216
[7] Overall lining dimension		614	739	864	989	1114	1239
[8] Overall cladding dimension		711	836	961	1086	1211	1336

Horizontal view – double leaf

Rebated

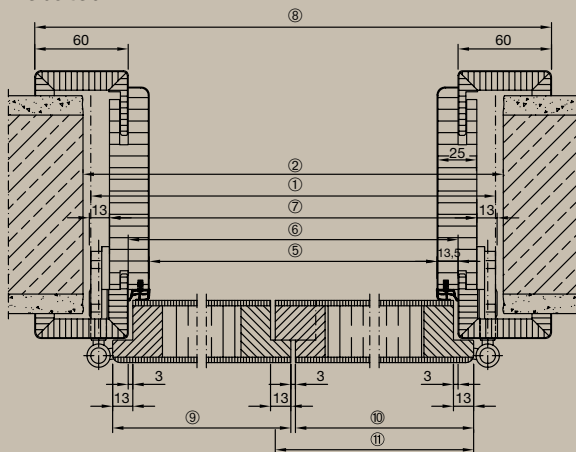

Flush

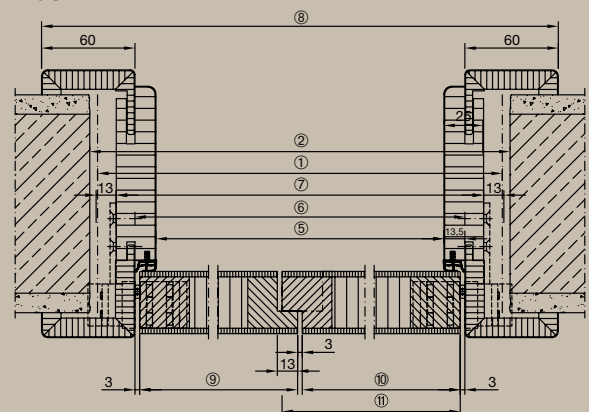

		1250	1375	1500	1750	1875	2000	2250	2500
[1] Nominal size width		1250	1375	1500	1750	1875	2000	2250	2500
[2] Wall opening		1260	1385	1510	1760	1885	2010	2260	2510
[5] Clear passage dimension		1176	1301	1426	1676	1801	1926	2176	2426
[6] Frame hold dimension		1203	1328	1453	1703	1828	1953	2203	2453
[7] Overall lining dimension		1226	1351	1476	1726	1851	1976	2226	2476
[8] Overall cladding dimension		1323	1448	1573	1823	1948	2073	2323	2573
[9] Overall door leaf dimension Traffic leaf	Rebated	610	735	735	860	985	985	1110	1235
	Flush	597	722	722	847	972	972	1097	1222
[10] Overall door leaf dimension Fixed leaf with meeting style*	Rebated	610	610	735	860	860	985	1110	1235
	Flush	597	597	722	847	847	972	1097	1222
[11] Overall door leaf dimension Fixed leaf with counter rebate	Rebated	623	623	748	873	873	998	1123	1248
	Flush	610	610	735	860	860	985	1110	1235

* Only for Carolina door styles
All dimensions in mm



Experience Hörmann quality

With Hörmann, you can easily plan for new construction and modernisation. Carefully matched solutions offer you the very best in perfectly designed products for every area.

Garage doors

Optimally match your personal architectural style: up-and-over or sectional doors made of steel or timber.

Door operators

Enjoy extra convenience and break-in resistant security: Hörmann operators for garage doors and entrance gates.

Entrance doors

Our comprehensive entrance door ranges include models that fit almost every need and requirement.

Timber internal doors

The high quality timber internal doors give your home an extra level of comfort and match your personal style perfectly.

Steel doors

Sturdy doors for your whole home, from basement to roof.

Frames

Choose from our comprehensive range of products for new construction, expansion and modernisation.

www.hoermann.com



Garage doors and door operators



Timber internal doors



Steel doors

Hörmann: Quality without Compromise



Hörmann KG Amshausen, Germany



Hörmann KG Antriebstechnik, Germany



Hörmann KG Brandis, Germany



Hörmann KG Brockhagen, Germany



Hörmann KG Dissen, Germany



Hörmann KG Eckelhausen, Germany



Hörmann KG Freisen, Germany



Hörmann KG Ichtshausen, Germany



Hörmann KG Werne, Germany



Hörmann Genk NV, Belgium



Hörmann Alkmaar B.V., Netherlands



Hörmann Legnica Sp. z o.o., Poland



Hörmann Beijing, China



Hörmann Tianjin, China



Hörmann LLC, Montgomery IL, USA



Hörmann Flexon LLC, Burgettstown PA, USA

Hörmann is the only manufacturer worldwide that offers you a complete range of all major building products from one source. We manufacture in highly-specialised factories using the latest production technologies. The close-meshed network of sales and service companies throughout Europe, and activities in the USA and China, make Hörmann your strong partner for first-class building products, offering “Quality without Compromise”.

GARAGE DOORS
OPERATORS
INDUSTRIAL DOORS
LOADING EQUIPMENT
HINGED DOORS
DOOR FRAMES

