

# Dock shelters and seals

Overview of Spare Parts: Valid from 01.03.2017

**HÖRMANN**

# Hörmann Subsidiaries and Affiliates

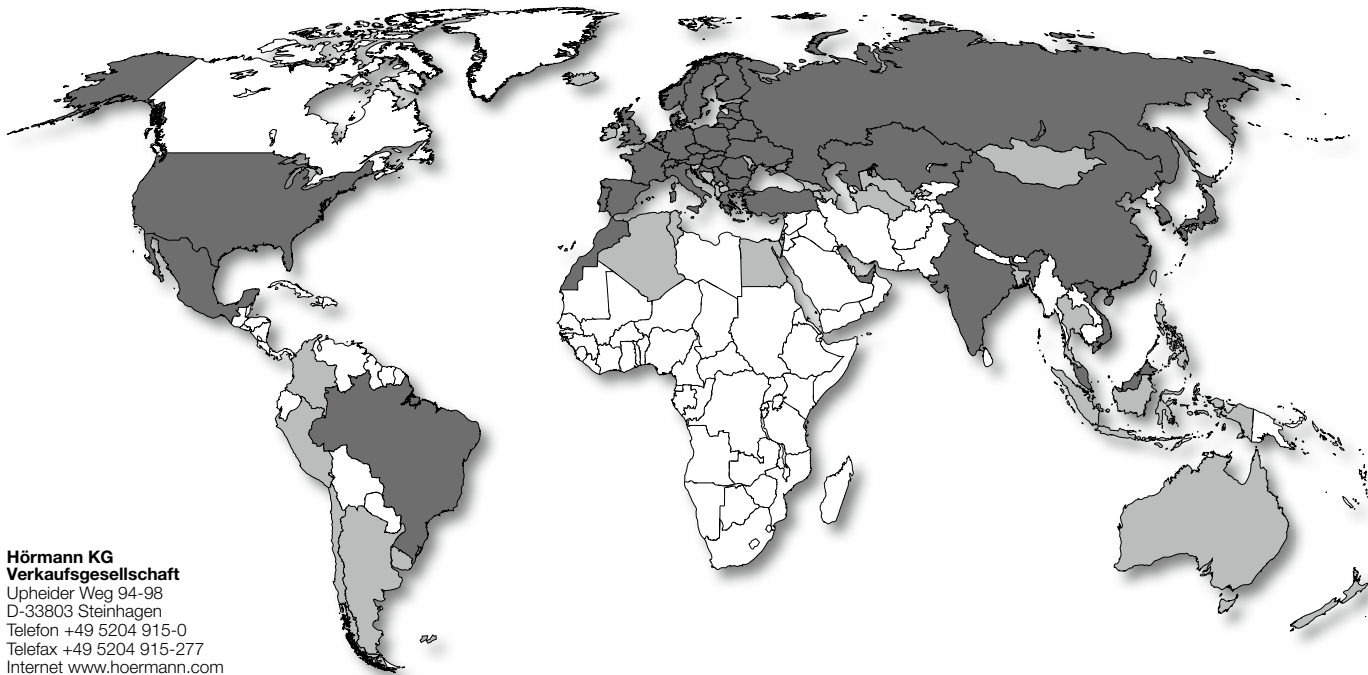

**Hörmann KG  
Verkaufsgesellschaft**  
Upheider Weg 94-98  
D-33803 Steinhagen  
Telefon +49 5204 915-0  
Telefax +49 5204 915-277  
Internet www.hoermann.com

**Hörmann international sales organizations**

**International sales partners**

## Hörmann international sales organizations

**Hörmann Austria**  
A-5310 Mondsee  
info@hoermann.at

**Hörmann Danmark**  
DK-8920 Randers  
info@hoermann.dk

**Hörmann Hrvatska**  
HR-10000 Zagreb  
info@hoermann.hr

**Hörmann Malaysia**  
MAL-40150 Shah Alam,  
Selangor  
sales@hoermann.com.my

**Hörmann Portugal**  
P-2710-297 Sintra  
info@hoermann.pt

**Hörmann Türkiye**  
TR-Istanbul 34788  
Tasdelen-Ümraniye  
info.ist@hoermann.com.tr

**Hörmann Baltic**  
LT-14247 Vilnius r.  
info@hoermann.lt

**Hörmann Eesti**  
EST-76505 Saue  
in:info.tll@hoermann.ee

**Hörmann Hungária**  
H-2310 Szigetszentmiklós  
info@hoermann.hu

**Hörmann Maroc**  
MA-28810 Mohammedia  
info@hoermann.ma

**Hörmann Romania**  
RO-077040, Chiajna,  
Județul Ilfov  
info@hoermann.ro

**Hörmann UK**  
GB-Leicestershire  
LE67 4JW  
info@hoermann.co.uk

**Hörmann Belarus**  
BY-220125 Minsk  
s.kobrynets.min@hoermann.by

**Hörmann España**  
E-08228 Terrassa  
info.cat@hoermann.es

**Hörmann India**  
IND-Andhra Pradesh-500 015  
info@shaktihoermann.com

**Hörmann Mexico**  
MEX-66350  
Santa Catarina  
info@hoermann.com.mx

**Hörmann Russia**  
RUS-196626  
Sankt Petersburg  
info@hoermann.ru

**Hörmann Ukraine**  
UA-08300 Boryspil,  
Kyivska Obl.  
info@hoermann.com.ua

**Hörmann Belgium**  
B-3700 Tongeren  
info@hoermann.be

**Hörmann Finland**  
FIN-02420 Jorvas  
info@mesvac.fi

**Hörmann Italia**  
I-38015 Lavis (Trento)  
info@hoermann.it

**Hörmann Middle East  
& Africa**  
UAE-Dubai  
info.dxb@hoermann.com

**Hörmann Schweiz**  
CH-4702 Oensingen  
info@hoermann.ch

**Hörmann Vietnam**  
VN-Bac Ninh Province  
info.han@hoermann.vn

**Hörmann Brasil**  
BR-05305 002 São Paulo SP  
info.sao@hoermann.com.br

**Hörmann Flexon**  
USA-Burgettstown,  
PA 15021  
info@hoermann-flexon.com

**Hörmann Japan**  
JP-103-0 002 Tokyo  
t.takasu.tok@hoermann.jp

**Hörmann Nederland**  
NL-3771 MB Barneveld  
info@hoermann.nl

**Hörmann Serbia**  
SRB-11271 Beograd-Surčin  
info@hoermann.rs

**Hörmann Bulgaria**  
BG-1532 Sofia  
info.sof@hoermann.bg

**Hörmann France**  
F-89107 Sens  
info@hoermann.fr

**Hörmann Kazakhstan**  
KZ-050004 Almaty  
info@hoermann.kz

**Hörmann Norge**  
N-4640 Søgne  
info@hoermann.no

**Hörmann Slovenská  
republika**  
SK-903 01 Senec  
info.bts@hoermann.com

**Hörmann Česká republika**  
CZ-252 68 Středokluky  
info@hoermann.cz

**Hörmann Hellas**  
GR-19400 Koropi  
info@hoermann.gr

**Hörmann Korea**  
KR-Kyunggi-do 463-400  
info@hoermann.co.kr

**Hörmann Polska**  
PL-62-052 Komorniki  
info@hoermann.pl

**Hörmann Svenska**  
S-70369 Örebro  
info@hoermann.se

**Hörmann China**  
CN-100176 Beijing  
info@hoermann.cn

**Hörmann Hong Kong**  
HK-25 Westlands Road,  
Quarry Bay  
info@hoermann.com.hk

**Hörmann LLC**  
USA-60538 Montgomery,  
Illinois  
info@hoermann.us

You can find more details on our foreign subsidiaries and respective regional sales offices at [www.hoermann.com](http://www.hoermann.com)

## International sales partners

Ägypten  
Albanien  
Algerien  
Argentinien  
Armenien  
Aserbaidschan

Australien  
Bangladesch  
Bosnien-Herzegowina  
Chile  
Finnland  
Georgien

Indonesien  
Irland  
Island  
Israel  
Kolumbien  
Kosovo

Luxemburg  
Malta  
Mazedonien  
Moldawien  
Mongolei  
Montenegro

Neuseeland  
Peru  
Philippinen  
Slowenien  
Taiwan  
Thailand





Tunesien  
Turkmenistan  
Uruguay  
Usbekistan  
Venezuela

Prices in €. Copyright. No part of this price list may be reproduced without our permission. All details subject to change.

# Contents

	Page
■ <b>Flap Shelters DS/DT</b>	<b>4</b>
Overview of components	4
Side flaps DSL / DSS	5
Side flaps DSLR / DSSR	13
Side flaps DTL / DTS	21
Side flaps DTLR / DTSR	23
Side flap DSS G	25
Side flap DSSR G	27
Side flap DTS G	29
Side flaps DTLR G / DTSR G	30
Side flap DSN	31
Side flap DSN G	34
Top flap DSL (G) / DSS (G) / DSLR (G) / DSSR (G) with Hörmann logo	36
Top flap DTL (G) / DTS (G) / DTLR (G) / DTSR (G) with Hörmann logo	42
Top flap DSN(G) with Hörmann logo	43
Side cladding	46
Top cladding	53
Weather strip profile	60
U-profile	62
Aluminium angle profile	64
Tubular profile	65
Various spare parts	66
Optional Extras	69
■ <b>Dock shelter DDF</b>	<b>72</b>
Overview of components	72
DDF until 07.07	73
DDF from 07-07	76
DDF 7	79
Fitting material	85
■ <b>Inflatable Dock Seal</b>	<b>86</b>
Overview of components	86
DAS 3 / DAS G 3	87
DAK 3	94
Fitting material	99
■ <b>Spare Parts Order Form</b>	<b>102</b>
■ <b>General Terms and Conditions of Sale and Delivery</b>	<b>103</b>

## Symbols Used

Symbol	Description
	Price on request
	Please note the extended delivery times
	Prices marked with a dot indicate articles that are <b>available from stock</b> or are available immediately ex works.
	Article has been replaced

# Flap Shelters DS/DT

## Overview of components

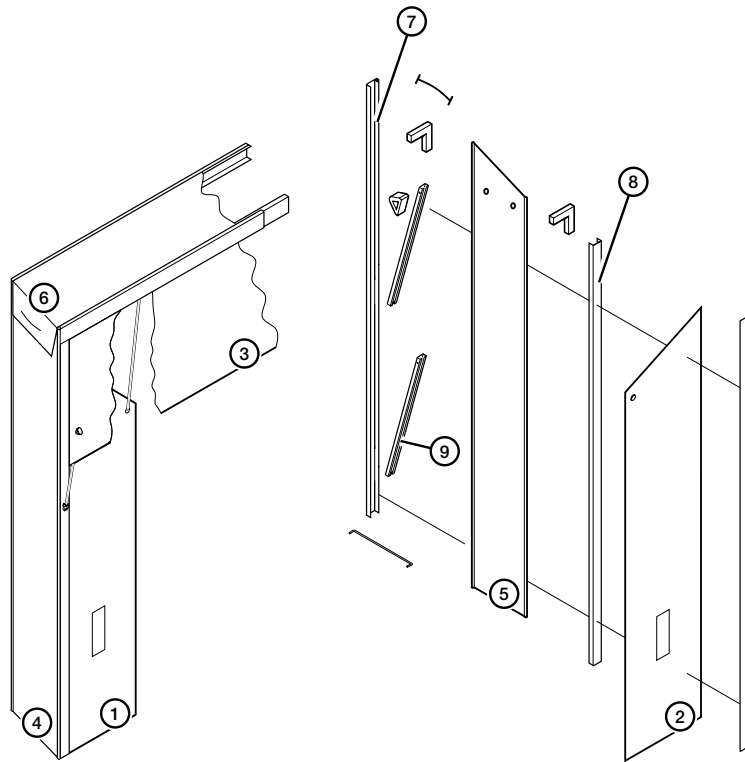

Flap dock shelters DSL / DTL

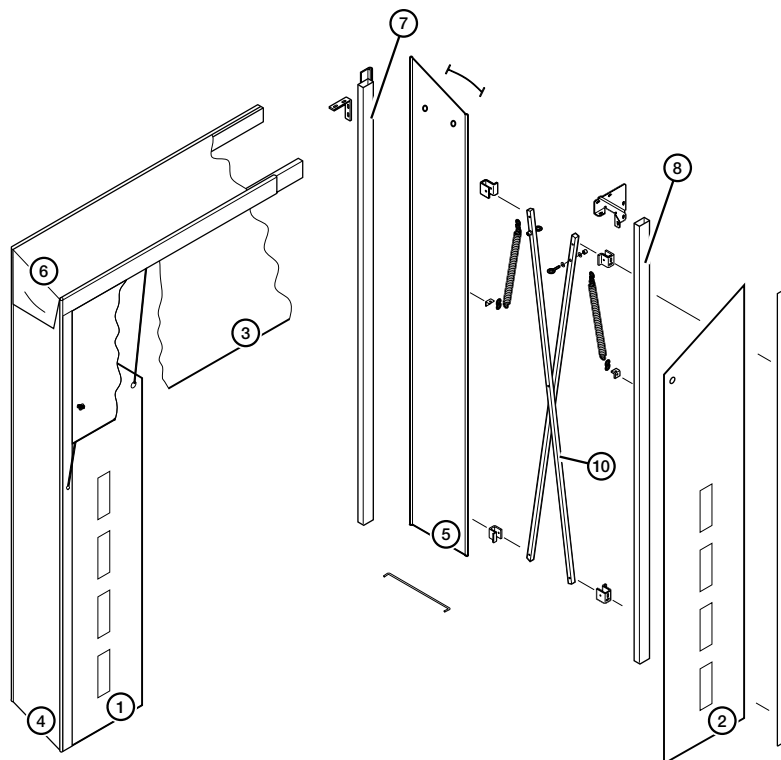

Flap dock shelters DSS

1	Side flap, left	4	Side cladding, left	7	Frame profile, front
2	Side flap, right	5	Side cladding, right	8	Frame profile, rear
3	Top flap	6	Top cladding	9	Link arm
				10	Scissor arm



# Flap Shelters DS / DT

## Side flaps DSL / DSS

Article	Description	Production period	Art. no.	Quantity	
 <p>Image: on right</p>	<b>Side flap DSL</b> <b>Width: 700 mm</b> <b>Dock shelter height: 2800 mm</b> <b>Right</b> <ul style="list-style-type: none"> <li>• Black / white</li> <li>• Grey / white</li> <li>• Blue / white</li> <li>• Black / yellow</li> <li>• Grey / yellow</li> <li>• Blue / yellow</li> <li>• Black / red</li> <li>• Grey / red</li> <li>• Blue / red</li> <li>• Black / orange</li> <li>• Grey / orange</li> <li>• Blue / orange</li> </ul>	from 04.2015 from 04.2015 from 04.2015 from 04.2015 from 04.2015 from 04.2015 from 04.2015 from 04.2015 from 04.2015 from 04.2015 from 04.2015 from 04.2015 from 04.2015	40008 40104 40056 40010 40106 40058 40014 40110 40062 40012 40108 40060	_____ _____ _____ _____ _____ _____ _____ _____ _____ _____ _____ _____	/each /each /each /each /each /each /each /each /each /each /each /each
	<b>Side flap DSL</b> <b>Width: 700 mm</b> <b>Dock shelter height: 2800 mm</b> <b>Left</b> <ul style="list-style-type: none"> <li>• Black / white</li> <li>• Grey / white</li> <li>• Blue / white</li> <li>• Black / yellow</li> <li>• Grey / yellow</li> <li>• Blue / yellow</li> <li>• Black / red</li> <li>• Grey / red</li> <li>• Blue / red</li> <li>• Black / orange</li> <li>• Grey / orange</li> <li>• Blue / orange</li> </ul>	from 04.2015 from 04.2015 from 04.2015 from 04.2015 from 04.2015 from 04.2015 from 04.2015 from 04.2015 from 04.2015 from 04.2015 from 04.2015 from 04.2015	40000 40096 40048 40002 40098 40050 40006 40102 40054 40004 40100 40052	_____ _____ _____ _____ _____ _____ _____ _____ _____ _____ _____	/each /each /each /each /each /each /each /each /each /each /each /each
	<b>Side flap DSL</b> <b>Width: 600 mm</b> <b>Dock shelter height: 2800 mm</b> <b>Right</b> <ul style="list-style-type: none"> <li>• Black / white</li> <li>• Grey / white</li> <li>• Blue / white</li> <li>• Black / yellow</li> <li>• Grey / yellow</li> <li>• Blue / yellow</li> <li>• Black / red</li> <li>• Grey / red</li> <li>• Blue / red</li> <li>• Black / orange</li> <li>• Grey / orange</li> <li>• Blue / orange</li> </ul>	from 04.2015 from 04.2015 from 04.2015 from 04.2015 from 04.2015 from 04.2015 from 04.2015 from 04.2015 from 04.2015 from 04.2015 from 04.2015 from 04.2015	40024 40120 40072 40026 40122 40074 40030 40126 40078 40028 40124 40076	_____ _____ _____ _____ _____ _____ _____ _____ _____ _____ _____	/each /each /each /each /each /each /each /each /each /each /each /each

<b>ORDER</b>	Customer no.: _____	Order no./com.: _____	<b>Please take information from the data label!</b>	
			<b>Order no.:</b> _____	<b>Type:</b> _____
	Customer name: _____		<b>Dock shelter / seal no.:</b> _____	<b>Year of manufacture:</b> _____
	Shipping address: _____		<b>Serial no.:</b> _____	
Place/date: _____		Stamp and signature _____		

# Flap Shelters DS / DT

## Side flaps DSL / DSS

Article	Description	Production period	Art. no.	Quantity	
	<b>Side flap DSL</b> <b>Width: 600 mm</b> <b>Dock shelter height: 2800 mm</b> <b>Left</b> <ul style="list-style-type: none"> <li>• Black / white from 04.2015 40016 _____ <b>/each</b></li> <li>• Grey / white from 04.2015 40112 _____ <b>/each</b></li> <li>• Blue / white from 04.2015 40064 _____ <b>/each</b></li> <li>• Black / yellow from 04.2015 40018 _____ <b>/each</b></li> <li>• Grey / yellow from 04.2015 40114 _____ <b>/each</b></li> <li>• Blue / yellow from 04.2015 40066 _____ <b>/each</b></li> <li>• Black / red from 04.2015 40022 _____ <b>/each</b></li> <li>• Grey / red from 04.2015 40118 _____ <b>/each</b></li> <li>• Blue / red from 04.2015 40070 _____ <b>/each</b></li> <li>• Black / orange from 04.2015 40020 _____ <b>/each</b></li> <li>• Grey / orange from 04.2015 40116 _____ <b>/each</b></li> <li>• Blue / orange from 04.2015 40068 _____ <b>/each</b></li> </ul>			Quantity	
	<b>Side flap DSL</b> <b>Width: 700 mm</b> <b>Dock shelter height: 3000 mm</b> <b>Right</b> <ul style="list-style-type: none"> <li>• Black / white from 04.2015 40009 _____ <b>/each</b></li> <li>• Grey / white from 04.2015 40105 _____ <b>/each</b></li> <li>• Blue / white from 04.2015 40057 _____ <b>/each</b></li> <li>• Black / yellow from 04.2015 40011 _____ <b>/each</b></li> <li>• Grey / yellow from 04.2015 40107 _____ <b>/each</b></li> <li>• Blue / yellow from 04.2015 40059 _____ <b>/each</b></li> <li>• Black / red from 04.2015 40015 _____ <b>/each</b></li> <li>• Grey / red from 04.2015 40111 _____ <b>/each</b></li> <li>• Blue / red from 04.2015 40063 _____ <b>/each</b></li> <li>• Black / orange from 04.2015 40013 _____ <b>/each</b></li> <li>• Grey / orange from 04.2015 40109 _____ <b>/each</b></li> <li>• Blue / orange from 04.2015 40061 _____ <b>/each</b></li> </ul>			Quantity	
	<b>Side flap DSL</b> <b>Width: 700 mm</b> <b>Dock shelter height: 3000 mm</b> <b>Left</b> <ul style="list-style-type: none"> <li>• Black / white from 04.2015 40001 _____ <b>/each</b></li> <li>• Grey / white from 04.2015 40097 _____ <b>/each</b></li> <li>• Blue / white from 04.2015 40049 _____ <b>/each</b></li> <li>• Black / yellow from 04.2015 40003 _____ <b>/each</b></li> <li>• Grey / yellow from 04.2015 40099 _____ <b>/each</b></li> <li>• Blue / yellow from 04.2015 40051 _____ <b>/each</b></li> <li>• Black / red from 04.2015 40007 _____ <b>/each</b></li> <li>• Grey / red from 04.2015 40103 _____ <b>/each</b></li> <li>• Blue / red from 04.2015 40055 _____ <b>/each</b></li> <li>• Black / orange from 04.2015 40005 _____ <b>/each</b></li> <li>• Grey / orange from 04.2015 40101 _____ <b>/each</b></li> <li>• Blue / orange from 04.2015 40053 _____ <b>/each</b></li> </ul>			Quantity	



Image: on right

<b>ORDER</b>	Customer no.:	Order no./com.:	<b>Please take information from the data label!</b>	
			<b>Order no.:</b>	<b>Type:</b>
	Customer name:		<b>Dock shelter / seal no.:</b>	<b>Year of manufacture:</b>
	Shipping address:		<b>Serial no.:</b>	
Place/date:		Stamp and signature		

# Flap Shelters DS / DT

## Side flaps DSL / DSS

Article	Description	Production period	Art. no.	Quantity	
 <p>Image: on right</p>	<b>Side flap DSL</b> <b>Width: 600 mm</b> <b>Dock shelter height: 3000 mm</b> <b>Right</b> <ul style="list-style-type: none"> <li>• Black / white</li> <li>• Grey / white</li> <li>• Blue / white</li> <li>• Black / yellow</li> <li>• Grey / yellow</li> <li>• Blue / yellow</li> <li>• Black / red</li> <li>• Grey / red</li> <li>• Blue / red</li> <li>• Black / orange</li> <li>• Grey / orange</li> <li>• Blue / orange</li> </ul>	from 04.2015 from 04.2015 from 04.2015 from 04.2015 from 04.2015 from 04.2015 from 04.2015 from 04.2015 from 04.2015 from 04.2015 from 04.2015 from 04.2015 from 04.2015	40025 40121 40073 40027 40123 40075 40031 40127 40079 40029 40125 40077	_____ _____ _____ _____ _____ _____ _____ _____ _____ _____ _____ _____	/each /each /each /each /each /each /each /each /each /each /each /each
	<b>Side flap DSL</b> <b>Width: 600 mm</b> <b>Dock shelter height: 3000 mm</b> <b>Left</b> <ul style="list-style-type: none"> <li>• Black / white</li> <li>• Grey / white</li> <li>• Blue / white</li> <li>• Black / yellow</li> <li>• Grey / yellow</li> <li>• Blue / yellow</li> <li>• Black / red</li> <li>• Grey / red</li> <li>• Blue / red</li> <li>• Black / orange</li> <li>• Grey / orange</li> <li>• Blue / orange</li> </ul>	from 04.2015 from 04.2015 from 04.2015 from 04.2015 from 04.2015 from 04.2015 from 04.2015 from 04.2015 from 04.2015 from 04.2015 from 04.2015 from 04.2015	40017 40113 40065 40019 40115 40067 40023 40119 40071 40021 40117 40069	_____ _____ _____ _____ _____ _____ _____ _____ _____ _____ _____	/each /each /each /each /each /each /each /each /each /each /each
	<b>Side flap DSL</b> <b>Width: 700 mm</b> <b>Dock shelter height: 3500 mm</b> <b>Right</b> <ul style="list-style-type: none"> <li>• Black / white</li> <li>• Grey / white</li> <li>• Blue / white</li> <li>• Black / yellow</li> <li>• Grey / yellow</li> <li>• Blue / yellow</li> <li>• Black / red</li> <li>• Grey / red</li> <li>• Blue / red</li> <li>• Black / orange</li> <li>• Grey / orange</li> <li>• Blue / orange</li> </ul>	from 05.2005 from 05.2005 from 05.2005 from 05.2005 from 05.2005 from 05.2005 from 04.2015 from 04.2015 from 04.2015 from 04.2015 from 04.2015 from 04.2015	2010177 2010178 2010179 2010180 2010181 2010182 40038 40134 40086 40036 40132 40084	_____ _____ _____ _____ _____ _____ _____ _____ _____ _____ _____	/each /each /each /each /each /each /each /each /each /each /each

<b>ORDER</b>	Customer no.: _____	Order no./com.: _____	<b>Please take information from the data label!</b>	
	Customer name: _____	Shipping address: _____	Order no.: _____	Type: _____
	Place/date: _____	Stamp and signature _____	Dock shelter / seal no.: _____	Year of manufacture: _____
			Serial no.: _____	

# Flap Shelters DS / DT

## Side flaps DSL / DSS

Article	Description	Production period	Art. no.	Quantity	
 <p>Image: on right</p>	<b>Side flap DSL</b> <b>Width: 700 mm</b> <b>Dock shelter height: 3500 mm</b> <b>Left</b>			Quantity	
	<ul style="list-style-type: none"> <li>• Black / white</li> <li>• Grey / white</li> <li>• Blue / white</li> <li>• Black / yellow</li> <li>• Grey / yellow</li> <li>• Blue / yellow</li> <li>• Black / red</li> <li>• Grey / red</li> <li>• Blue / red</li> <li>• Black / orange</li> <li>• Grey / orange</li> <li>• Blue / orange</li> </ul>	<ul style="list-style-type: none"> <li>from 05.2005</li> <li>from 05.2005</li> <li>from 05.2005</li> <li>from 05.2005</li> <li>from 05.2005</li> <li>from 05.2005</li> <li>from 04.2015</li> <li>from 04.2015</li> <li>from 04.2015</li> <li>from 04.2015</li> <li>from 04.2015</li> <li>from 04.2015</li> </ul>	<ul style="list-style-type: none"> <li>2010183</li> <li>2010184</li> <li>2010185</li> <li>2010186</li> <li>2010187</li> <li>2010188</li> <li>40034</li> <li>40130</li> <li>40082</li> <li>40032</li> <li>40128</li> <li>40080</li> </ul>	<ul style="list-style-type: none"> <li>_____</li> <li>_____</li> <li>_____</li> <li>_____</li> <li>_____</li> <li>_____</li> <li>_____</li> <li>_____</li> <li>_____</li> <li>_____</li> <li>_____</li> <li>_____</li> </ul>	<ul style="list-style-type: none"> <li>/each</li> <li>/each</li> <li>/each</li> <li>/each</li> <li>/each</li> <li>/each</li> <li>/each</li> <li>/each</li> <li>/each</li> <li>/each</li> <li>/each</li> <li>/each</li> </ul>
	<b>Side flap DSL</b> <b>Width: 600 mm</b> <b>Dock shelter height: 3500 mm</b> <b>Right</b>			Quantity	
	<ul style="list-style-type: none"> <li>• Black / white</li> <li>• Grey / white</li> <li>• Blue / white</li> <li>• Black / yellow</li> <li>• Grey / yellow</li> <li>• Blue / yellow</li> <li>• Black / red</li> <li>• Grey / red</li> <li>• Blue / red</li> <li>• Black / orange</li> <li>• Grey / orange</li> <li>• Blue / orange</li> </ul>	<ul style="list-style-type: none"> <li>from 05.2005</li> <li>from 05.2005</li> <li>from 05.2005</li> <li>from 05.2005</li> <li>from 05.2005</li> <li>from 05.2005</li> <li>from 04.2015</li> <li>from 04.2015</li> <li>from 04.2015</li> <li>from 04.2015</li> <li>from 04.2015</li> <li>from 04.2015</li> </ul>	<ul style="list-style-type: none"> <li>2010189</li> <li>2010190</li> <li>2010191</li> <li>2010192</li> <li>2010193</li> <li>2010194</li> <li>40046</li> <li>40140</li> <li>40094</li> <li>40044</li> <li>40140</li> <li>40092</li> </ul>	<ul style="list-style-type: none"> <li>_____</li> <li>_____</li> <li>_____</li> <li>_____</li> <li>_____</li> <li>_____</li> <li>_____</li> <li>_____</li> <li>_____</li> <li>_____</li> <li>_____</li> <li>_____</li> </ul>	<ul style="list-style-type: none"> <li>/each</li> <li>/each</li> <li>/each</li> <li>/each</li> <li>/each</li> <li>/each</li> <li>/each</li> <li>/each</li> <li>/each</li> <li>/each</li> <li>/each</li> <li>/each</li> </ul>
	<b>Side flap DSL</b> <b>Width: 600 mm</b> <b>Dock shelter height: 3500 mm</b> <b>Left</b>			Quantity	
	<ul style="list-style-type: none"> <li>• Black / white</li> <li>• Grey / white</li> <li>• Blue / white</li> <li>• Black / yellow</li> <li>• Grey / yellow</li> <li>• Blue / yellow</li> <li>• Black / red</li> <li>• Grey / red</li> <li>• Blue / red</li> <li>• Black / orange</li> <li>• Grey / orange</li> <li>• Blue / orange</li> </ul>	<ul style="list-style-type: none"> <li>from 05.2005</li> <li>from 05.2005</li> <li>from 05.2005</li> <li>from 05.2005</li> <li>from 05.2005</li> <li>from 05.2005</li> <li>from 04.2015</li> <li>from 04.2015</li> <li>from 04.2015</li> <li>from 04.2015</li> <li>from 04.2015</li> <li>from 04.2015</li> </ul>	<ul style="list-style-type: none"> <li>2010195</li> <li>2010196</li> <li>2010197</li> <li>2010198</li> <li>2010199</li> <li>2010200</li> <li>40042</li> <li>40138</li> <li>40090</li> <li>40040</li> <li>40136</li> <li>40088</li> </ul>	<ul style="list-style-type: none"> <li>_____</li> <li>_____</li> <li>_____</li> <li>_____</li> <li>_____</li> <li>_____</li> <li>_____</li> <li>_____</li> <li>_____</li> <li>_____</li> <li>_____</li> <li>_____</li> </ul>	<ul style="list-style-type: none"> <li>/each</li> <li>/each</li> <li>/each</li> <li>/each</li> <li>/each</li> <li>/each</li> <li>/each</li> <li>/each</li> <li>/each</li> <li>/each</li> <li>/each</li> <li>/each</li> </ul>

<b>ORDER</b>	Customer no.:	Order no./com.:	<b>Please take information from the data label!</b>	
	Customer name:	Shipping address:		Order no.:
	Shipping address:			Type:
	Place/date:			Dock shelter / seal no.:
			Stamp and signature	Year of manufacture:
				Serial no.:

# Flap Shelters DS / DT

## Side flaps DSL / DSS

Article	Description	Production period	Art. no.	Quantity	
 <p>Image: on right</p>	<b>Side flap DSL</b> <b>Width: 700 mm</b> <b>Dock shelter height: 3750 mm</b> <b>Right</b>			Quantity	
	<ul style="list-style-type: none"> <li>• Black / white</li> </ul>	from 05.2005	2010201	_____	/each
	<ul style="list-style-type: none"> <li>• Grey / white</li> </ul>	from 05.2005	2010202	_____	/each
	<ul style="list-style-type: none"> <li>• Blue / white</li> </ul>	from 05.2005	2010203	_____	/each
	<ul style="list-style-type: none"> <li>• Black / yellow</li> </ul>	from 05.2005	2010204	_____	/each
	<ul style="list-style-type: none"> <li>• Grey / yellow</li> </ul>	from 05.2005	2010205	_____	/each
	<ul style="list-style-type: none"> <li>• Blue / yellow</li> </ul>	from 05.2005	2010206	_____	/each
	<ul style="list-style-type: none"> <li>• Black / red</li> </ul>	from 04.2015	40039	_____	/each
	<ul style="list-style-type: none"> <li>• Grey / red</li> </ul>	from 04.2015	40135	_____	/each
	<ul style="list-style-type: none"> <li>• Blue / red</li> </ul>	from 04.2015	40087	_____	/each
	<ul style="list-style-type: none"> <li>• Black / orange</li> </ul>	from 04.2015	40037	_____	/each
	<ul style="list-style-type: none"> <li>• Grey / orange</li> </ul>	from 04.2015	40133	_____	/each
	<ul style="list-style-type: none"> <li>• Blue / orange</li> </ul>	from 04.2015	40085	_____	/each
	<b>Side flap DSL</b> <b>Width: 700 mm</b> <b>Dock shelter height: 3750 mm</b> <b>Left</b>			Quantity	
	<ul style="list-style-type: none"> <li>• Black / white</li> </ul>	from 05.2005	2010207	_____	/each
	<ul style="list-style-type: none"> <li>• Grey / white</li> </ul>	from 05.2005	2010208	_____	/each
	<ul style="list-style-type: none"> <li>• Blue / white</li> </ul>	from 05.2005	2010209	_____	/each
<ul style="list-style-type: none"> <li>• Black / yellow</li> </ul>	from 05.2005	2010210	_____	/each	
<ul style="list-style-type: none"> <li>• Grey / yellow</li> </ul>	from 05.2005	2010211	_____	/each	
<ul style="list-style-type: none"> <li>• Blue / yellow</li> </ul>	from 05.2005	2010212	_____	/each	
<ul style="list-style-type: none"> <li>• Black / red</li> </ul>	from 04.2015	40035	_____	/each	
<ul style="list-style-type: none"> <li>• Grey / red</li> </ul>	from 04.2015	40131	_____	/each	
<ul style="list-style-type: none"> <li>• Blue / red</li> </ul>	from 04.2015	40083	_____	/each	
<ul style="list-style-type: none"> <li>• Black / orange</li> </ul>	from 04.2015	40033	_____	/each	
<ul style="list-style-type: none"> <li>• Grey / orange</li> </ul>	from 04.2015	40129	_____	/each	
<ul style="list-style-type: none"> <li>• Blue / orange</li> </ul>	from 04.2015	40081	_____	/each	
<b>Side flap DSL</b> <b>Width: 600 mm</b> <b>Dock shelter height: 3750 mm</b> <b>Right</b>			Quantity		
<ul style="list-style-type: none"> <li>• Black / white</li> </ul>	from 05.2005	2010213	_____	/each	
<ul style="list-style-type: none"> <li>• Grey / white</li> </ul>	from 05.2005	2010214	_____	/each	
<ul style="list-style-type: none"> <li>• Blue / white</li> </ul>	from 05.2005	2010215	_____	/each	
<ul style="list-style-type: none"> <li>• Black / yellow</li> </ul>	from 05.2005	2010216	_____	/each	
<ul style="list-style-type: none"> <li>• Grey / yellow</li> </ul>	from 05.2005	2010217	_____	/each	
<ul style="list-style-type: none"> <li>• Blue / yellow</li> </ul>	from 05.2005	2010218	_____	/each	
<ul style="list-style-type: none"> <li>• Black / red</li> </ul>	from 04.2015	40047	_____	/each	
<ul style="list-style-type: none"> <li>• Grey / red</li> </ul>	from 04.2015	40143	_____	/each	
<ul style="list-style-type: none"> <li>• Blue / red</li> </ul>	from 04.2015	40095	_____	/each	
<ul style="list-style-type: none"> <li>• Black / orange</li> </ul>	from 04.2015	40045	_____	/each	
<ul style="list-style-type: none"> <li>• Grey / orange</li> </ul>	from 04.2015	40141	_____	/each	
<ul style="list-style-type: none"> <li>• Blue / orange</li> </ul>	from 04.2015	40093	_____	/each	

<b>ORDER</b>	Customer no.: _____	Order no./com.: _____	<b>Please take information from the data label!</b>	
			<b>Order no.:</b> _____	<b>Type:</b> _____
	Customer name: _____		<b>Dock shelter / seal no.:</b> _____	<b>Year of manufacture:</b> _____
	Shipping address: _____		<b>Serial no.:</b> _____	
	Place/date: _____		Stamp and signature _____	

# Flap Shelters DS / DT

## Side flaps DSL / DSS

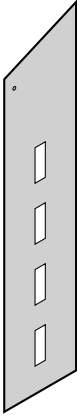
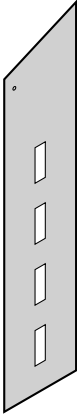
Article	Description	Production period	Art. no.	Quantity	
 <p>Image: on right</p>	<b>Side flap DSL</b> <b>Width: 600 mm</b> <b>Dock shelter height: 3750 mm</b> <b>Left</b>			Quantity	
	<ul style="list-style-type: none"> <li>Black / white</li> </ul>	from 05.2005	2010219	_____	/each
	<ul style="list-style-type: none"> <li>Grey / white</li> </ul>	from 05.2005	2010220	_____	/each
	<ul style="list-style-type: none"> <li>Blue / white</li> </ul>	from 05.2005	2010221	_____	/each
	<ul style="list-style-type: none"> <li>Black / yellow</li> </ul>	from 05.2005	2010222	_____	/each
	<ul style="list-style-type: none"> <li>Grey / yellow</li> </ul>	from 05.2005	2010223	_____	/each
	<ul style="list-style-type: none"> <li>Blue / yellow</li> </ul>	from 05.2005	2010224	_____	/each
	<ul style="list-style-type: none"> <li>Black / red</li> </ul>	from 04.2015	40043	_____	/each
	<ul style="list-style-type: none"> <li>Grey / red</li> </ul>	from 04.2015	40139	_____	/each
	<ul style="list-style-type: none"> <li>Blue / red</li> </ul>	from 04.2015	40091	_____	/each
	<ul style="list-style-type: none"> <li>Black / orange</li> </ul>	from 04.2015	40041	_____	/each
	<ul style="list-style-type: none"> <li>Grey / orange</li> </ul>	from 04.2015	40137	_____	/each
	<ul style="list-style-type: none"> <li>Blue / orange</li> </ul>	from 04.2015	40089	_____	/each
 <p>Image: on right</p>	<b>Side flap DSS</b> <b>Width: 700 mm</b> <b>Dock shelter height: 3500 mm</b> <b>Right</b>			Quantity	
	<ul style="list-style-type: none"> <li>Black / white</li> </ul>	from 05.2005	2010225	_____	/each
	<ul style="list-style-type: none"> <li>Grey / white</li> </ul>	from 05.2005	2010226	_____	/each
	<ul style="list-style-type: none"> <li>Blue / white</li> </ul>	from 05.2005	2010227	_____	/each
	<ul style="list-style-type: none"> <li>Black / yellow</li> </ul>	from 05.2005	2010228	_____	/each
	<ul style="list-style-type: none"> <li>Grey / yellow</li> </ul>	from 05.2005	2010229	_____	/each
	<ul style="list-style-type: none"> <li>Blue / yellow</li> </ul>	from 05.2005	2010230	_____	/each
	<ul style="list-style-type: none"> <li>Black / red</li> </ul>	from 04.2015	40389	_____	/each
	<ul style="list-style-type: none"> <li>Grey / red</li> </ul>	from 04.2015	40421	_____	/each
	<ul style="list-style-type: none"> <li>Blue / red</li> </ul>	from 04.2015	40405	_____	/each
	<ul style="list-style-type: none"> <li>Black / orange</li> </ul>	from 04.2015	40387	_____	/each
	<ul style="list-style-type: none"> <li>Grey / orange</li> </ul>	from 04.2015	40419	_____	/each
	<ul style="list-style-type: none"> <li>Blue / orange</li> </ul>	from 04.2015	40403	_____	/each
 <p>Image: on right</p>	<b>Side flap DSS</b> <b>Width: 700 mm</b> <b>Dock shelter height: 3500 mm</b> <b>Left</b>			Quantity	
	<ul style="list-style-type: none"> <li>Black / white</li> </ul>	from 05.2005	2010231	_____	/each
	<ul style="list-style-type: none"> <li>Grey / white</li> </ul>	from 05.2005	2010232	_____	/each
	<ul style="list-style-type: none"> <li>Blue / white</li> </ul>	from 05.2005	2010233	_____	/each
	<ul style="list-style-type: none"> <li>Black / yellow</li> </ul>	from 05.2005	2010234	_____	/each
	<ul style="list-style-type: none"> <li>Grey / yellow</li> </ul>	from 05.2005	2010235	_____	/each
	<ul style="list-style-type: none"> <li>Blue / yellow</li> </ul>	from 05.2005	2010236	_____	/each
	<ul style="list-style-type: none"> <li>Black / red</li> </ul>	from 04.2015	40385	_____	/each
	<ul style="list-style-type: none"> <li>Grey / red</li> </ul>	from 04.2015	40417	_____	/each
	<ul style="list-style-type: none"> <li>Blue / red</li> </ul>	from 04.2015	40401	_____	/each
	<ul style="list-style-type: none"> <li>Black / orange</li> </ul>	from 04.2015	40383	_____	/each
	<ul style="list-style-type: none"> <li>Grey / orange</li> </ul>	from 04.2015	40415	_____	/each
	<ul style="list-style-type: none"> <li>Blue / orange</li> </ul>	from 04.2015	40399	_____	/each

<b>ORDER</b>	Customer no.:	Order no./com.:	<b>Please take information from the data label!</b>	
	Customer name:	Shipping address:	Order no.:	Type:
	Place/date:		Dock shelter / seal no.:	Year of manufacture:
			Serial no.:	
			Stamp and signature	

# Flap Shelters DS / DT

## Side flaps DSL / DSS

Article	Description	Production period	Art. no.	Quantity	
	<b>Side flap DSS</b> <b>Width: 600 mm</b> <b>Dock shelter height: 3500 mm</b> <b>Right</b> <ul style="list-style-type: none"> <li>• Black / white</li> <li>• Grey / white</li> <li>• Blue / white</li> <li>• Black / yellow</li> <li>• Grey / yellow</li> <li>• Blue / yellow</li> <li>• Black / red</li> <li>• Grey / red</li> <li>• Blue / red</li> <li>• Black / orange</li> <li>• Grey / orange</li> <li>• Blue / orange</li> </ul>	<ul style="list-style-type: none"> <li>from 05.2005</li> <li>from 05.2005</li> <li>from 05.2005</li> <li>from 05.2005</li> <li>from 05.2005</li> <li>from 05.2005</li> <li>from 04.2015</li> <li>from 04.2015</li> <li>from 04.2015</li> <li>from 04.2015</li> <li>from 04.2015</li> <li>from 04.2015</li> </ul>	<ul style="list-style-type: none"> <li>2010237</li> <li>2010238</li> <li>2010239</li> <li>2010240</li> <li>2010241</li> <li>2010242</li> <li>40397</li> <li>40429</li> <li>40413</li> <li>40395</li> <li>40427</li> <li>40411</li> </ul>	Quantity	<ul style="list-style-type: none"> <li>_____ /each</li> <li>_____ /each</li> <li>_____ /each</li> <li>_____ /each</li> <li>_____ /each</li> <li>_____ /each</li> <li>_____ /each</li> <li>_____ /each</li> <li>_____ /each</li> <li>_____ /each</li> <li>_____ /each</li> <li>_____ /each</li> </ul>
	 <b>Side flap DSS</b> <b>Width: 600 mm</b> <b>Dock shelter height: 3500 mm</b> <b>Left</b> <ul style="list-style-type: none"> <li>• Black / white</li> <li>• Grey / white</li> <li>• Blue / white</li> <li>• Black / yellow</li> <li>• Grey / yellow</li> <li>• Blue / yellow</li> <li>• Black / red</li> <li>• Grey / red</li> <li>• Blue / red</li> <li>• Black / orange</li> <li>• Grey / orange</li> <li>• Blue / orange</li> </ul>	<ul style="list-style-type: none"> <li>from 05.2005</li> <li>from 05.2005</li> <li>from 05.2005</li> <li>from 05.2005</li> <li>from 05.2005</li> <li>from 05.2005</li> <li>from 04.2015</li> <li>from 04.2015</li> <li>from 04.2015</li> <li>from 04.2015</li> <li>from 04.2015</li> <li>from 04.2015</li> </ul>	<ul style="list-style-type: none"> <li>2010243</li> <li>2010244</li> <li>2010245</li> <li>2010246</li> <li>2010247</li> <li>2010248</li> <li>40393</li> <li>40425</li> <li>40409</li> <li>40391</li> <li>40423</li> <li>40407</li> </ul>	Quantity	<ul style="list-style-type: none"> <li>_____ /each</li> <li>_____ /each</li> <li>_____ /each</li> <li>_____ /each</li> <li>_____ /each</li> <li>_____ /each</li> <li>_____ /each</li> <li>_____ /each</li> <li>_____ /each</li> <li>_____ /each</li> <li>_____ /each</li> <li>_____ /each</li> </ul>
	<b>Side flap DSS</b> <b>Width: 700 mm</b> <b>Dock shelter height: 3750 mm</b> <b>Right</b> <ul style="list-style-type: none"> <li>• Black / white</li> <li>• Grey / white</li> <li>• Blue / white</li> <li>• Black / yellow</li> <li>• Grey / yellow</li> <li>• Blue / yellow</li> <li>• Black / red</li> <li>• Grey / red</li> <li>• Blue / red</li> <li>• Black / orange</li> <li>• Grey / orange</li> <li>• Blue / orange</li> </ul>	<ul style="list-style-type: none"> <li>from 05.2005</li> <li>from 05.2005</li> <li>from 05.2005</li> <li>from 05.2005</li> <li>from 05.2005</li> <li>from 05.2005</li> <li>from 04.2015</li> <li>from 04.2015</li> <li>from 04.2015</li> <li>from 04.2015</li> <li>from 04.2015</li> <li>from 04.2015</li> </ul>	<ul style="list-style-type: none"> <li>2010249</li> <li>2010250</li> <li>2010251</li> <li>2010252</li> <li>2010253</li> <li>2010254</li> <li>40390</li> <li>40422</li> <li>40406</li> <li>40388</li> <li>40420</li> <li>40404</li> </ul>	Quantity	<ul style="list-style-type: none"> <li>_____ /each</li> <li>_____ /each</li> <li>_____ /each</li> <li>_____ /each</li> <li>_____ /each</li> <li>_____ /each</li> <li>_____ /each</li> <li>_____ /each</li> <li>_____ /each</li> <li>_____ /each</li> <li>_____ /each</li> <li>_____ /each</li> </ul>

Image: on right

<b>ORDER</b>	Customer no.: _____	Order no./com.: _____	<b>Please take information from the data label!</b>	
			<b>Order no.:</b> _____	<b>Type:</b> _____
	Customer name: _____		<b>Dock shelter / seal no.:</b> _____	<b>Year of manufacture:</b> _____
	Shipping address: _____		<b>Serial no.:</b> _____	
	Place/date: _____		Stamp and signature _____	

# Flap Shelters DS / DT

## Side flaps DSL / DSS

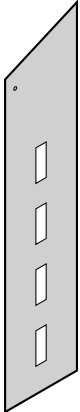
Article	Description	Production period	Art. no.	Quantity	
	<b>Side flap DSS</b> <b>Width: 700 mm</b> <b>Dock shelter height: 3750 mm</b> <b>Left</b> <ul style="list-style-type: none"> <li>• Black / white</li> <li>• Grey / white</li> <li>• Blue / white</li> <li>• Black / yellow</li> <li>• Grey / yellow</li> <li>• Blue / yellow</li> <li>• Black / red</li> <li>• Grey / red</li> <li>• Blue / red</li> <li>• Black / orange</li> <li>• Grey / orange</li> <li>• Blue / orange</li> </ul>	<ul style="list-style-type: none"> <li>from 05.2005</li> <li>from 05.2005</li> <li>from 05.2005</li> <li>from 05.2005</li> <li>from 05.2005</li> <li>from 05.2005</li> <li>from 04.2015</li> <li>from 04.2015</li> <li>from 04.2015</li> <li>from 04.2015</li> <li>from 04.2015</li> <li>from 04.2015</li> </ul>	<ul style="list-style-type: none"> <li>2010255</li> <li>2010256</li> <li>2010257</li> <li>2010258</li> <li>2010259</li> <li>2010260</li> <li>40386</li> <li>40418</li> <li>40402</li> <li>40384</li> <li>40416</li> <li>40400</li> </ul>	_____ _____ _____ _____ _____ _____ _____ _____ _____ _____ _____ _____ _____	/each /each /each /each /each /each /each /each /each /each /each /each /each
	<b>Side flap DSS</b> <b>Width: 600 mm</b> <b>Dock shelter height: 3750 mm</b> <b>Right</b> <ul style="list-style-type: none"> <li>• Black / white</li> <li>• Grey / white</li> <li>• Blue / white</li> <li>• Black / yellow</li> <li>• Grey / yellow</li> <li>• Blue / yellow</li> <li>• Black / red</li> <li>• Grey / red</li> <li>• Blue / red</li> <li>• Black / orange</li> <li>• Grey / orange</li> <li>• Blue / orange</li> </ul>	<ul style="list-style-type: none"> <li>from 05.2005</li> <li>from 05.2005</li> <li>from 05.2005</li> <li>from 05.2005</li> <li>from 05.2005</li> <li>from 05.2005</li> <li>from 04.2015</li> <li>from 04.2015</li> <li>from 04.2015</li> <li>from 04.2015</li> <li>from 04.2015</li> <li>from 04.2015</li> </ul>	<ul style="list-style-type: none"> <li>2010261</li> <li>2010262</li> <li>2010263</li> <li>2010264</li> <li>2010265</li> <li>2010266</li> <li>40398</li> <li>40430</li> <li>40414</li> <li>40396</li> <li>40428</li> <li>40412</li> </ul>	_____ _____ _____ _____ _____ _____ _____ _____ _____ _____ _____ _____	/each /each /each /each /each /each /each /each /each /each /each /each /each
	<b>Side flap DSS</b> <b>Width: 600 mm</b> <b>Dock shelter height: 3750 mm</b> <b>Left</b> <ul style="list-style-type: none"> <li>• Black / white</li> <li>• Grey / white</li> <li>• Blue / white</li> <li>• Black / yellow</li> <li>• Grey / yellow</li> <li>• Blue / yellow</li> <li>• Black / red</li> <li>• Grey / red</li> <li>• Blue / red</li> <li>• Black / orange</li> <li>• Grey / orange</li> <li>• Blue / orange</li> </ul>	<ul style="list-style-type: none"> <li>from 05.2005</li> <li>from 05.2005</li> <li>from 05.2005</li> <li>from 05.2005</li> <li>from 05.2005</li> <li>from 05.2005</li> <li>from 04.2015</li> <li>from 04.2015</li> <li>from 04.2015</li> <li>from 04.2015</li> <li>from 04.2015</li> <li>from 04.2015</li> </ul>	<ul style="list-style-type: none"> <li>2010267</li> <li>2010268</li> <li>2010269</li> <li>2010270</li> <li>2010271</li> <li>2010272</li> <li>40394</li> <li>40426</li> <li>40410</li> <li>40392</li> <li>40424</li> <li>40408</li> </ul>	_____ _____ _____ _____ _____ _____ _____ _____ _____ _____ _____ _____	/each /each /each /each /each /each /each /each /each /each /each /each /each

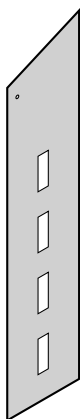



Image: on right

<b>ORDER</b>	Customer no.: _____	Order no./com.: _____	<b>Please take information from the data label!</b>	
			<b>Order no.:</b> _____	<b>Type:</b> _____
	Customer name: _____		<b>Dock shelter / seal no.:</b> _____	<b>Year of manufacture:</b> _____
	Shipping address: _____		<b>Serial no.:</b> _____	
Place/date: _____		Stamp and signature _____		



# Flap Shelters DS / DT

## Side flaps DSLR / DSSR

Article	Description	Production period	Art. no.	Quantity	
 <p>Image: on right</p>	<b>Side flap DSLR</b> <b>Width: 700 mm</b> <b>Dock shelter height: 2800 mm</b> <b>Right</b> <ul style="list-style-type: none"> <li>• Black / white</li> <li>• Grey / white</li> <li>• Blue / white</li> <li>• Black / yellow</li> <li>• Grey / yellow</li> <li>• Blue / yellow</li> <li>• Black / red</li> <li>• Grey / red</li> <li>• Blue / red</li> <li>• Black / orange</li> <li>• Grey / orange</li> <li>• Blue / orange</li> </ul>	from 04.2015 from 04.2015 from 04.2015 from 04.2015 from 04.2015 from 04.2015 from 04.2015 from 04.2015 from 04.2015 from 04.2015 from 04.2015 from 04.2015 from 04.2015	40152 40278 40216 40154 40280 40218 40158 40284 40222 40156 40282 40220	_____ _____ _____ _____ _____ _____ _____ _____ _____ _____ _____ _____	/each /each /each /each /each /each /each /each /each /each /each /each
	<b>Side flap DSLR</b> <b>Width: 700 mm</b> <b>Dock shelter height: 2800 mm</b> <b>Left</b> <ul style="list-style-type: none"> <li>• Black / white</li> <li>• Grey / white</li> <li>• Blue / white</li> <li>• Black / yellow</li> <li>• Grey / yellow</li> <li>• Blue / yellow</li> <li>• Black / red</li> <li>• Grey / red</li> <li>• Blue / red</li> <li>• Black / orange</li> <li>• Grey / orange</li> <li>• Blue / orange</li> </ul>	from 04.2015 from 04.2015 from 04.2015 from 04.2015 from 04.2015 from 04.2015 from 04.2015 from 04.2015 from 04.2015 from 04.2015 from 04.2015 from 04.2015 from 04.2015	40144 40270 40208 40146 40272 40210 40150 40276 40214 40148 40274 40212	_____ _____ _____ _____ _____ _____ _____ _____ _____ _____ _____	/each /each /each /each /each /each /each /each /each /each /each /each
	<b>Side flap DSLR</b> <b>Width: 600 mm</b> <b>Dock shelter height: 2800 mm</b> <b>Right</b> <ul style="list-style-type: none"> <li>• Black / white</li> <li>• Grey / white</li> <li>• Blue / white</li> <li>• Black / yellow</li> <li>• Grey / yellow</li> <li>• Blue / yellow</li> <li>• Black / red</li> <li>• Grey / red</li> <li>• Blue / red</li> <li>• Black / orange</li> <li>• Grey / orange</li> <li>• Blue / orange</li> </ul>	from 04.2015 from 04.2015 from 04.2015 from 04.2015 from 04.2015 from 04.2015 from 04.2015 from 04.2015 from 04.2015 from 04.2015 from 04.2015 from 04.2015 from 04.2015	40168 40294 40232 40170 40296 40234 40174 40300 40238 40172 40298 40236	_____ _____ _____ _____ _____ _____ _____ _____ _____ _____ _____	/each /each /each /each /each /each /each /each /each /each /each /each

<b>ORDER</b>	Customer no.: _____	Order no./com.: _____	<b>Please take information from the data label!</b>	
	Customer name: _____	Shipping address: _____	<b>Order no.:</b> _____	<b>Type:</b> _____
	Place/date: _____	Stamp and signature _____	<b>Dock shelter / seal no.:</b> _____	<b>Year of manufacture:</b> _____
			<b>Serial no.:</b> _____	

# Flap Shelters DS / DT

## Side flaps DSLR / DSSR

Article	Description	Production period	Art. no.	Quantity	
 Image: on right	<b>Side flap DSLR</b> <b>Width: 600 mm</b> <b>Dock shelter height: 2800 mm</b> <b>Left</b> <ul style="list-style-type: none"> <li>• Black / white</li> <li>• Grey / white</li> <li>• Blue / white</li> <li>• Black / yellow</li> <li>• Grey / yellow</li> <li>• Blue / yellow</li> <li>• Black / red</li> <li>• Grey / red</li> <li>• Blue / red</li> <li>• Black / orange</li> <li>• Grey / orange</li> <li>• Blue / orange</li> </ul>	from 04.2015 from 04.2015 from 04.2015 from 04.2015 from 04.2015 from 04.2015 from 04.2015 from 04.2015 from 04.2015 from 04.2015 from 04.2015 from 04.2015	40160 40286 40224 40162 40288 40226 40166 40292 40230 40164 40290 40228	Quantity	_____ _____ _____ _____ _____ _____ _____ _____ _____ _____ _____ _____
	<b>Side flap DSLR</b> <b>Width: 700 mm</b> <b>Dock shelter height: 3000 mm</b> <b>Right</b> <ul style="list-style-type: none"> <li>• Black / white</li> <li>• Grey / white</li> <li>• Blue / white</li> <li>• Black / yellow</li> <li>• Grey / yellow</li> <li>• Blue / yellow</li> <li>• Black / red</li> <li>• Grey / red</li> <li>• Blue / red</li> <li>• Black / orange</li> <li>• Grey / orange</li> <li>• Blue / orange</li> </ul>	from 04.2015 from 04.2015 from 04.2015 from 04.2015 from 04.2015 from 04.2015 from 04.2015 from 04.2015 from 04.2015 from 04.2015 from 04.2015 from 04.2015	40153 40279 40217 40155 40281 40219 40159 40285 40223 40157 40283 40221	Quantity	_____ _____ _____ _____ _____ _____ _____ _____ _____ _____ _____
	<b>Side flap DSLR</b> <b>Width: 700 mm</b> <b>Dock shelter height: 3000 mm</b> <b>Right</b> <ul style="list-style-type: none"> <li>• Black / white</li> <li>• Grey / white</li> <li>• Blue / white</li> <li>• Black / yellow</li> <li>• Grey / yellow</li> <li>• Blue / yellow</li> <li>• Black / red</li> <li>• Grey / red</li> <li>• Blue / red</li> <li>• Black / orange</li> <li>• Grey / orange</li> <li>• Blue / orange</li> </ul>	from 04.2015 from 04.2015 from 04.2015 from 04.2015 from 04.2015 from 04.2015 from 04.2015 from 04.2015 from 04.2015 from 04.2015 from 04.2015 from 04.2015	40145 40271 40209 40147 40273 40211 40151 40277 40215 40149 40275 40213	Quantity	_____ _____ _____ _____ _____ _____ _____ _____ _____ _____ _____

ORDER	Customer no.: _____ Order no./com.: _____	<b>Please take information from the data label!</b>
	Customer name: _____	<b>Order no.:</b> _____ <b>Type:</b> _____
	Shipping address: _____	<b>Dock shelter / seal no.:</b> _____ <b>Year of manufacture:</b> _____
	_____	<b>Serial no.:</b> _____
	Place/date: _____	Stamp and signature _____

# Flap Shelters DS / DT

## Side flaps DSLR / DSSR

Article	Description	Production period	Art. no.	Quantity	
 <p>Image: on right</p>	<b>Side flap DSLR</b> <b>Width: 600 mm</b> <b>Dock shelter height: 3000 mm</b> <b>Right</b>			Quantity	
	<ul style="list-style-type: none"> <li>• Black / white</li> <li>• Grey / white</li> <li>• Blue / white</li> <li>• Black / yellow</li> <li>• Grey / yellow</li> <li>• Blue / yellow</li> <li>• Black / red</li> <li>• Grey / red</li> <li>• Blue / red</li> <li>• Black / orange</li> <li>• Grey / orange</li> <li>• Blue / orange</li> </ul>	<ul style="list-style-type: none"> <li>from 04.2015</li> <li>from 04.2015</li> <li>from 04.2015</li> <li>from 04.2015</li> <li>from 04.2015</li> <li>from 04.2015</li> <li>from 04.2015</li> <li>from 04.2015</li> <li>from 04.2015</li> <li>from 04.2015</li> <li>from 04.2015</li> <li>from 04.2015</li> </ul>	<ul style="list-style-type: none"> <li>40169</li> <li>40295</li> <li>40233</li> <li>40171</li> <li>40297</li> <li>40235</li> <li>40175</li> <li>40301</li> <li>40239</li> <li>40173</li> <li>40299</li> <li>40237</li> </ul>	<ul style="list-style-type: none"> <li>_____</li> <li>_____</li> <li>_____</li> <li>_____</li> <li>_____</li> <li>_____</li> <li>_____</li> <li>_____</li> <li>_____</li> <li>_____</li> <li>_____</li> <li>_____</li> </ul>	<ul style="list-style-type: none"> <li>/each</li> <li>/each</li> <li>/each</li> <li>/each</li> <li>/each</li> <li>/each</li> <li>/each</li> <li>/each</li> <li>/each</li> <li>/each</li> <li>/each</li> <li>/each</li> </ul>
	<b>Side flap DSLR</b> <b>Width: 600 mm</b> <b>Dock shelter height: 3000 mm</b> <b>Left</b>			Quantity	
	<ul style="list-style-type: none"> <li>• Black / white</li> <li>• Grey / white</li> <li>• Blue / white</li> <li>• Black / yellow</li> <li>• Grey / yellow</li> <li>• Blue / yellow</li> <li>• Black / red</li> <li>• Grey / red</li> <li>• Blue / red</li> <li>• Black / orange</li> <li>• Grey / orange</li> <li>• Blue / orange</li> </ul>	<ul style="list-style-type: none"> <li>from 04.2015</li> <li>from 04.2015</li> <li>from 04.2015</li> <li>from 04.2015</li> <li>from 04.2015</li> <li>from 04.2015</li> <li>from 04.2015</li> <li>from 04.2015</li> <li>from 04.2015</li> <li>from 04.2015</li> <li>from 04.2015</li> <li>from 04.2015</li> </ul>	<ul style="list-style-type: none"> <li>40161</li> <li>40287</li> <li>40225</li> <li>40163</li> <li>40289</li> <li>40227</li> <li>40167</li> <li>40293</li> <li>40231</li> <li>40165</li> <li>40291</li> <li>40229</li> </ul>	<ul style="list-style-type: none"> <li>_____</li> <li>_____</li> <li>_____</li> <li>_____</li> <li>_____</li> <li>_____</li> <li>_____</li> <li>_____</li> <li>_____</li> <li>_____</li> <li>_____</li> <li>_____</li> </ul>	<ul style="list-style-type: none"> <li>/each</li> <li>/each</li> <li>/each</li> <li>/each</li> <li>/each</li> <li>/each</li> <li>/each</li> <li>/each</li> <li>/each</li> <li>/each</li> <li>/each</li> <li>/each</li> </ul>
	<b>Side flap DSLR</b> <b>Width: 700 mm</b> <b>Dock shelter height: 3500 mm</b> <b>Right</b>			Quantity	
	<ul style="list-style-type: none"> <li>• Black / white</li> <li>• Grey / white</li> <li>• Blue / white</li> <li>• Black / yellow</li> <li>• Grey / yellow</li> <li>• Blue / yellow</li> <li>• Black / red</li> <li>• Grey / red</li> <li>• Blue / red</li> <li>• Black / orange</li> <li>• Grey / orange</li> <li>• Blue / orange</li> </ul>	<ul style="list-style-type: none"> <li>from 04.2015</li> <li>from 04.2015</li> <li>from 04.2015</li> <li>from 04.2015</li> <li>from 04.2015</li> <li>from 04.2015</li> <li>from 04.2015</li> <li>from 04.2015</li> <li>from 04.2015</li> <li>from 04.2015</li> <li>from 04.2015</li> <li>from 04.2015</li> </ul>	<ul style="list-style-type: none"> <li>40182</li> <li>40306</li> <li>41138</li> <li>40180</li> <li>40308</li> <li>40244</li> <li>40198</li> <li>40324</li> <li>40260</li> <li>40196</li> <li>40322</li> <li>40258</li> </ul>	<ul style="list-style-type: none"> <li>_____</li> <li>_____</li> <li>_____</li> <li>_____</li> <li>_____</li> <li>_____</li> <li>_____</li> <li>_____</li> <li>_____</li> <li>_____</li> <li>_____</li> <li>_____</li> </ul>	<ul style="list-style-type: none"> <li>/each</li> <li>/each</li> <li>/each</li> <li>/each</li> <li>/each</li> <li>/each</li> <li>/each</li> <li>/each</li> <li>/each</li> <li>/each</li> <li>/each</li> <li>/each</li> </ul>

<b>ORDER</b>	Customer no.: _____	Order no./com.: _____	<b>Please take information from the data label!</b>	
			<b>Order no.:</b> _____	<b>Type:</b> _____
	Customer name: _____		<b>Dock shelter / seal no.:</b> _____	<b>Year of manufacture:</b> _____
	Shipping address: _____		<b>Serial no.:</b> _____	
Place/date: _____		Stamp and signature _____		

# Flap Shelters DS / DT

## Side flaps DSLR / DSSR



Article	Description	Production period	Art. no.	Quantity	
	<b>Side flap DSLR</b> <b>Width: 700 mm</b> <b>Dock shelter height: 3500 mm</b> <b>Left</b> <ul style="list-style-type: none"> <li>• Black / white</li> <li>• Grey / white</li> <li>• Blue / white</li> <li>• Black / yellow</li> <li>• Grey / yellow</li> <li>• Blue / yellow</li> <li>• Black / red</li> <li>• Grey / red</li> <li>• Blue / red</li> <li>• Black / orange</li> <li>• Grey / orange</li> <li>• Blue / orange</li> </ul>	<ul style="list-style-type: none"> <li>from 04.2015</li> <li>from 04.2015</li> <li>from 04.2015</li> <li>from 04.2015</li> <li>from 04.2015</li> <li>from 04.2015</li> <li>from 04.2015</li> <li>from 04.2015</li> <li>from 04.2015</li> <li>from 04.2015</li> <li>from 04.2015</li> <li>from 04.2015</li> </ul>	<ul style="list-style-type: none"> <li>40178</li> <li>40302</li> <li>40240</li> <li>40177</li> <li>40304</li> <li>40242</li> <li>40194</li> <li>40320</li> <li>40256</li> <li>40192</li> <li>40318</li> <li>40254</li> </ul>	Quantity _____ _____ _____ _____ _____ _____ _____ _____ _____ _____ _____ _____	/each /each /each /each /each /each /each /each /each /each /each /each /each
	 <b>Side flap DSLR</b> <b>Width: 600 mm</b> <b>Dock shelter height: 3500 mm</b> <b>Right</b> <ul style="list-style-type: none"> <li>• Black / white</li> <li>• Grey / white</li> <li>• Blue / white</li> <li>• Black / yellow</li> <li>• Grey / yellow</li> <li>• Blue / yellow</li> <li>• Black / red</li> <li>• Grey / red</li> <li>• Blue / red</li> <li>• Black / orange</li> <li>• Grey / orange</li> <li>• Blue / orange</li> </ul>	<ul style="list-style-type: none"> <li>from 04.2015</li> <li>from 04.2015</li> <li>from 04.2015</li> <li>from 04.2015</li> <li>from 04.2015</li> <li>from 04.2015</li> <li>from 04.2015</li> <li>from 04.2015</li> <li>from 04.2015</li> <li>from 04.2015</li> <li>from 04.2015</li> <li>from 04.2015</li> </ul>	<ul style="list-style-type: none"> <li>40188</li> <li>40314</li> <li>40250</li> <li>40190</li> <li>41141</li> <li>40252</li> <li>40206</li> <li>40332</li> <li>40268</li> <li>40204</li> <li>40330</li> <li>40266</li> </ul>	Quantity _____ _____ _____ _____ _____ _____ _____ _____ _____ _____ _____	/each /each /each /each /each /each /each /each /each /each /each /each /each
	<b>Side flap DSLR</b> <b>Width: 600 mm</b> <b>Dock shelter height: 3500 mm</b> <b>Left</b> <ul style="list-style-type: none"> <li>• Black / white</li> <li>• Grey / white</li> <li>• Blue / white</li> <li>• Black / yellow</li> <li>• Grey / yellow</li> <li>• Blue / yellow</li> <li>• Black / red</li> <li>• Grey / red</li> <li>• Blue / red</li> <li>• Black / orange</li> <li>• Grey / orange</li> <li>• Blue / orange</li> </ul>	<ul style="list-style-type: none"> <li>from 04.2015</li> <li>from 04.2015</li> <li>from 04.2015</li> <li>from 04.2015</li> <li>from 04.2015</li> <li>from 04.2015</li> <li>from 04.2015</li> <li>from 04.2015</li> <li>from 04.2015</li> <li>from 04.2015</li> <li>from 04.2015</li> <li>from 04.2015</li> </ul>	<ul style="list-style-type: none"> <li>40184</li> <li>40310</li> <li>40246</li> <li>40186</li> <li>40312</li> <li>40248</li> <li>40202</li> <li>40328</li> <li>40264</li> <li>40200</li> <li>40326</li> <li>40262</li> </ul>	Quantity _____ _____ _____ _____ _____ _____ _____ _____ _____ _____ _____	/each /each /each /each /each /each /each /each /each /each /each /each /each

Image: on right

<b>ORDER</b>	Customer no.: _____	Order no./com.: _____	<b>Please take information from the data label!</b>	
			<b>Order no.:</b> _____	<b>Type:</b> _____
	Customer name: _____		<b>Dock shelter / seal no.:</b> _____	<b>Year of manufacture:</b> _____
	Shipping address: _____		<b>Serial no.:</b> _____	
	Place/date: _____		Stamp and signature _____	

# Flap Shelters DS / DT

## Side flaps DSLR / DSSR

Article	Description	Production period	Art. no.	Quantity	
 <p>Image: on right</p>	<b>Side flap DSLR</b> <b>Width: 700 mm</b> <b>Dock shelter height: 3750 mm</b> <b>Right</b>			Quantity	
	<ul style="list-style-type: none"> <li>• Black / white</li> <li>• Grey / white</li> <li>• Blue / white</li> <li>• Black / yellow</li> <li>• Grey / yellow</li> <li>• Blue / yellow</li> <li>• Black / red</li> <li>• Grey / red</li> <li>• Blue / red</li> <li>• Black / orange</li> <li>• Grey / orange</li> <li>• Blue / orange</li> </ul>	<ul style="list-style-type: none"> <li>from 04.2015</li> <li>from 04.2015</li> <li>from 04.2015</li> <li>from 04.2015</li> <li>from 04.2015</li> <li>from 04.2015</li> <li>from 04.2015</li> <li>from 04.2015</li> <li>from 04.2015</li> <li>from 04.2015</li> <li>from 04.2015</li> <li>from 04.2015</li> </ul>	<ul style="list-style-type: none"> <li>40181</li> <li>40307</li> <li>41139</li> <li>40183</li> <li>40309</li> <li>40245</li> <li>40199</li> <li>40325</li> <li>40261</li> <li>40197</li> <li>40323</li> <li>40259</li> </ul>	<ul style="list-style-type: none"> <li>_____</li> <li>_____</li> <li>_____</li> <li>_____</li> <li>_____</li> <li>_____</li> <li>_____</li> <li>_____</li> <li>_____</li> <li>_____</li> <li>_____</li> <li>_____</li> </ul>	<ul style="list-style-type: none"> <li>/each</li> <li>/each</li> <li>/each</li> <li>/each</li> <li>/each</li> <li>/each</li> <li>/each</li> <li>/each</li> <li>/each</li> <li>/each</li> <li>/each</li> <li>/each</li> </ul>
	<b>Side flap DSLR</b> <b>Width: 700 mm</b> <b>Dock shelter height: 3750 mm</b> <b>Left</b>			Quantity	
	<ul style="list-style-type: none"> <li>• Black / white</li> <li>• Grey / white</li> <li>• Blue / white</li> <li>• Black / yellow</li> <li>• Grey / yellow</li> <li>• Blue / yellow</li> <li>• Black / red</li> <li>• Grey / red</li> <li>• Blue / red</li> <li>• Black / orange</li> <li>• Grey / orange</li> <li>• Blue / orange</li> </ul>	<ul style="list-style-type: none"> <li>from 04.2015</li> <li>from 04.2015</li> <li>from 04.2015</li> <li>from 04.2015</li> <li>from 04.2015</li> <li>from 04.2015</li> <li>from 04.2015</li> <li>from 04.2015</li> <li>from 04.2015</li> <li>from 04.2015</li> <li>from 04.2015</li> <li>from 04.2015</li> </ul>	<ul style="list-style-type: none"> <li>40176</li> <li>40303</li> <li>40241</li> <li>40179</li> <li>40305</li> <li>40243</li> <li>40195</li> <li>40321</li> <li>40257</li> <li>40193</li> <li>40319</li> <li>40255</li> </ul>	<ul style="list-style-type: none"> <li>_____</li> <li>_____</li> <li>_____</li> <li>_____</li> <li>_____</li> <li>_____</li> <li>_____</li> <li>_____</li> <li>_____</li> <li>_____</li> <li>_____</li> <li>_____</li> </ul>	<ul style="list-style-type: none"> <li>/each</li> <li>/each</li> <li>/each</li> <li>/each</li> <li>/each</li> <li>/each</li> <li>/each</li> <li>/each</li> <li>/each</li> <li>/each</li> <li>/each</li> <li>/each</li> </ul>
	<b>Side flap DSLR</b> <b>Width: 600 mm</b> <b>Dock shelter height: 3750 mm</b> <b>Right</b>			Quantity	
	<ul style="list-style-type: none"> <li>• Black / white</li> <li>• Grey / white</li> <li>• Blue / white</li> <li>• Black / yellow</li> <li>• Grey / yellow</li> <li>• Blue / yellow</li> <li>• Black / red</li> <li>• Grey / red</li> <li>• Blue / red</li> <li>• Black / orange</li> <li>• Grey / orange</li> <li>• Blue / orange</li> </ul>	<ul style="list-style-type: none"> <li>from 04.2015</li> <li>from 04.2015</li> <li>from 04.2015</li> <li>from 04.2015</li> <li>from 04.2015</li> <li>from 04.2015</li> <li>from 04.2015</li> <li>from 04.2015</li> <li>from 04.2015</li> <li>from 04.2015</li> <li>from 04.2015</li> <li>from 04.2015</li> </ul>	<ul style="list-style-type: none"> <li>40189</li> <li>41140</li> <li>40251</li> <li>40191</li> <li>40317</li> <li>40253</li> <li>40207</li> <li>40329</li> <li>40269</li> <li>40205</li> <li>40327</li> <li>40267</li> </ul>	<ul style="list-style-type: none"> <li>_____</li> <li>_____</li> <li>_____</li> <li>_____</li> <li>_____</li> <li>_____</li> <li>_____</li> <li>_____</li> <li>_____</li> <li>_____</li> <li>_____</li> <li>_____</li> </ul>	<ul style="list-style-type: none"> <li>/each</li> <li>/each</li> <li>/each</li> <li>/each</li> <li>/each</li> <li>/each</li> <li>/each</li> <li>/each</li> <li>/each</li> <li>/each</li> <li>/each</li> <li>/each</li> </ul>

<b>ORDER</b>	Customer no.: _____	Order no./com.: _____	<b>Please take information from the data label!</b>	
			<b>Order no.:</b> _____	<b>Type:</b> _____
	Customer name: _____		<b>Dock shelter / seal no.:</b> _____	<b>Year of manufacture:</b> _____
	Shipping address: _____		<b>Serial no.:</b> _____	
	Place/date: _____		Stamp and signature _____	

# Flap Shelters DS / DT

## Side flaps DSLR / DSSR

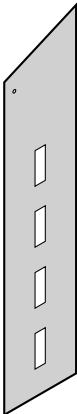
Article	Description	Production period	Art. no.	Quantity		
 <p>Image: on right</p>	<b>Side flap DSLR</b> <b>Width: 600 mm</b> <b>Dock shelter height: 3750 mm</b> <b>Left</b>			Quantity		
	<ul style="list-style-type: none"> <li>Black / white</li> </ul>	from 04.2015	40185	_____	/each	
	<ul style="list-style-type: none"> <li>Grey / white</li> </ul>	from 04.2015	40311	_____	/each	
	<ul style="list-style-type: none"> <li>Blue / white</li> </ul>	from 04.2015	40247	_____	/each	
	<ul style="list-style-type: none"> <li>Black / yellow</li> </ul>	from 04.2015	40187	_____	/each	
	<ul style="list-style-type: none"> <li>Grey / yellow</li> </ul>	from 04.2015	40313	_____	/each	
	<ul style="list-style-type: none"> <li>Blue / yellow</li> </ul>	from 04.2015	40249	_____	/each	
	<ul style="list-style-type: none"> <li>Black / red</li> </ul>	from 04.2015	40203	_____	/each	
	<ul style="list-style-type: none"> <li>Grey / red</li> </ul>	from 04.2015	40333	_____	/each	
	<ul style="list-style-type: none"> <li>Blue / red</li> </ul>	from 04.2015	40265	_____	/each	
	<ul style="list-style-type: none"> <li>Black / orange</li> </ul>	from 04.2015	40201	_____	/each	
	<ul style="list-style-type: none"> <li>Grey / orange</li> </ul>	from 04.2015	40331	_____	/each	
	<ul style="list-style-type: none"> <li>Blue / orange</li> </ul>	from 04.2015	40263	_____	/each	
 <p>Image: on right</p>	<b>Side flap DSSR</b> <b>Width: 700 mm</b> <b>Dock shelter height: 3500 mm</b> <b>Right</b>			Quantity		
	<ul style="list-style-type: none"> <li>Black / white</li> </ul>	from 04.2015	40495	_____	/each	
	<ul style="list-style-type: none"> <li>Grey / white</li> </ul>	from 04.2015	40559	_____	/each	
	<ul style="list-style-type: none"> <li>Blue / white</li> </ul>	from 04.2015	40527	_____	/each	
	<ul style="list-style-type: none"> <li>Black / yellow</li> </ul>	from 04.2015	40497	_____	/each	
	<ul style="list-style-type: none"> <li>Grey / yellow</li> </ul>	from 04.2015	40561	_____	/each	
	<ul style="list-style-type: none"> <li>Blue / yellow</li> </ul>	from 04.2015	40529	_____	/each	
	<ul style="list-style-type: none"> <li>Black / red</li> </ul>	from 04.2015	40513	_____	/each	
	<ul style="list-style-type: none"> <li>Grey / red</li> </ul>	from 04.2015	40577	_____	/each	
	<ul style="list-style-type: none"> <li>Blue / red</li> </ul>	from 04.2015	40545	_____	/each	
	<ul style="list-style-type: none"> <li>Black / orange</li> </ul>	from 04.2015	40511	_____	/each	
	<ul style="list-style-type: none"> <li>Grey / orange</li> </ul>	from 04.2015	40575	_____	/each	
	<ul style="list-style-type: none"> <li>Blue / orange</li> </ul>	from 04.2015	40543	_____	/each	
	<b>Side flap DSSR</b> <b>Width: 700 mm</b> <b>Dock shelter height: 3500 mm</b> <b>Left</b>				Quantity	
	<ul style="list-style-type: none"> <li>Black / white</li> </ul>	from 04.2015	40491	_____	/each	
	<ul style="list-style-type: none"> <li>Grey / white</li> </ul>	from 04.2015	40555	_____	/each	
<ul style="list-style-type: none"> <li>Blue / white</li> </ul>	from 04.2015	40523	_____	/each		
<ul style="list-style-type: none"> <li>Black / yellow</li> </ul>	from 04.2015	40493	_____	/each		
<ul style="list-style-type: none"> <li>Grey / yellow</li> </ul>	from 04.2015	40557	_____	/each		
<ul style="list-style-type: none"> <li>Blue / yellow</li> </ul>	from 04.2015	40525	_____	/each		
<ul style="list-style-type: none"> <li>Black / red</li> </ul>	from 04.2015	40509	_____	/each		
<ul style="list-style-type: none"> <li>Grey / red</li> </ul>	from 04.2015	40573	_____	/each		
<ul style="list-style-type: none"> <li>Blue / red</li> </ul>	from 04.2015	40541	_____	/each		
<ul style="list-style-type: none"> <li>Black / orange</li> </ul>	from 04.2015	40507	_____	/each		
<ul style="list-style-type: none"> <li>Grey / orange</li> </ul>	from 04.2015	40571	_____	/each		
<ul style="list-style-type: none"> <li>Blue / orange</li> </ul>	from 04.2015	40539	_____	/each		

<b>ORDER</b>	Customer no.:	Order no./com.:	<b>Please take information from the data label!</b>	
	Customer name:	Shipping address:	Order no.:	Type:
	Place/date:	Stamp and signature	Dock shelter / seal no.:	Year of manufacture:
			Serial no.:	

# Flap Shelters DS / DT

## Side flaps DSLR / DSSR

Article	Description	Production period	Art. no.	Quantity	
	<b>Side flap DSSR</b> <b>Width: 600 mm</b> <b>Dock shelter height: 3500 mm</b> <b>Right</b> <ul style="list-style-type: none"> <li>• Black / white</li> <li>• Grey / white</li> <li>• Blue / white</li> <li>• Black / yellow</li> <li>• Grey / yellow</li> <li>• Blue / yellow</li> <li>• Black / red</li> <li>• Grey / red</li> <li>• Blue / red</li> <li>• Black / orange</li> <li>• Grey / orange</li> <li>• Blue / orange</li> </ul>	<ul style="list-style-type: none"> <li>from 04.2015</li> <li>from 04.2015</li> <li>from 04.2015</li> <li>from 04.2015</li> <li>from 04.2015</li> <li>from 04.2015</li> <li>from 04.2015</li> <li>from 04.2015</li> <li>from 04.2015</li> <li>from 04.2015</li> <li>from 04.2015</li> <li>from 04.2015</li> </ul>	<ul style="list-style-type: none"> <li>40503</li> <li>40567</li> <li>40535</li> <li>40505</li> <li>40569</li> <li>40537</li> <li>40521</li> <li>40585</li> <li>40553</li> <li>40519</li> <li>40583</li> <li>40551</li> </ul>	Quantity _____ _____ _____ _____ _____ _____ _____ _____ _____ _____ _____ _____	/each /each /each /each /each /each /each /each /each /each /each /each /each
	 <b>Side flap DSSR</b> <b>Width: 600 mm</b> <b>Dock shelter height: 3500 mm</b> <b>Left</b> <ul style="list-style-type: none"> <li>• Black / white</li> <li>• Grey / white</li> <li>• Blue / white</li> <li>• Black / yellow</li> <li>• Grey / yellow</li> <li>• Blue / yellow</li> <li>• Black / red</li> <li>• Grey / red</li> <li>• Blue / red</li> <li>• Black / orange</li> <li>• Grey / orange</li> <li>• Blue / orange</li> </ul>	<ul style="list-style-type: none"> <li>from 04.2015</li> <li>from 04.2015</li> <li>from 04.2015</li> <li>from 04.2015</li> <li>from 04.2015</li> <li>from 04.2015</li> <li>from 04.2015</li> <li>from 04.2015</li> <li>from 04.2015</li> <li>from 04.2015</li> <li>from 04.2015</li> <li>from 04.2015</li> </ul>	<ul style="list-style-type: none"> <li>40499</li> <li>40563</li> <li>40531</li> <li>40501</li> <li>40565</li> <li>40533</li> <li>40517</li> <li>40581</li> <li>40549</li> <li>40515</li> <li>40579</li> <li>40547</li> </ul>	Quantity _____ _____ _____ _____ _____ _____ _____ _____ _____ _____ _____	/each /each /each /each /each /each /each /each /each /each /each /each
	<b>Side flap DSSR</b> <b>Width: 700 mm</b> <b>Dock shelter height: 3750 mm</b> <b>Right</b> <ul style="list-style-type: none"> <li>• Black / white</li> <li>• Grey / white</li> <li>• Blue / white</li> <li>• Black / yellow</li> <li>• Grey / yellow</li> <li>• Blue / yellow</li> <li>• Black / red</li> <li>• Grey / red</li> <li>• Blue / red</li> <li>• Black / orange</li> <li>• Grey / orange</li> <li>• Blue / orange</li> </ul>	<ul style="list-style-type: none"> <li>from 04.2015</li> <li>from 04.2015</li> <li>from 04.2015</li> <li>from 04.2015</li> <li>from 04.2015</li> <li>from 04.2015</li> <li>from 04.2015</li> <li>from 04.2015</li> <li>from 04.2015</li> <li>from 04.2015</li> <li>from 04.2015</li> <li>from 04.2015</li> </ul>	<ul style="list-style-type: none"> <li>40496</li> <li>40560</li> <li>40528</li> <li>40498</li> <li>40562</li> <li>40530</li> <li>40514</li> <li>40578</li> <li>40546</li> <li>40512</li> <li>40576</li> <li>40544</li> </ul>	Quantity _____ _____ _____ _____ _____ _____ _____ _____ _____ _____ _____	/each /each /each /each /each /each /each /each /each /each /each /each

Image: on right

<b>ORDER</b>	Customer no.: _____	Order no./com.: _____	<b>Please take information from the data label!</b>	
			<b>Order no.:</b> _____	<b>Type:</b> _____
	Customer name: _____		<b>Dock shelter / seal no.:</b> _____	<b>Year of manufacture:</b> _____
	Shipping address: _____		<b>Serial no.:</b> _____	
Place/date: _____		Stamp and signature _____		

# Flap Shelters DS / DT

## Side flaps DSLR / DSSR

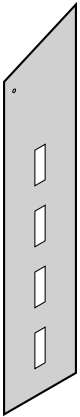
Article	Description	Production period	Art. no.	Quantity	
	<b>Side flap DSSR</b> <b>Width: 700 mm</b> <b>Dock shelter height: 3750 mm</b> <b>Left</b> <ul style="list-style-type: none"> <li>• Black / white</li> <li>• Grey / white</li> <li>• Blue / white</li> <li>• Black / yellow</li> <li>• Grey / yellow</li> <li>• Blue / yellow</li> <li>• Black / red</li> <li>• Grey / red</li> <li>• Blue / red</li> <li>• Black / orange</li> <li>• Grey / orange</li> <li>• Blue / orange</li> </ul>	<ul style="list-style-type: none"> <li>from 04.2015</li> <li>from 04.2015</li> <li>from 04.2015</li> <li>from 04.2015</li> <li>from 04.2015</li> <li>from 04.2015</li> <li>from 04.2015</li> <li>from 04.2015</li> <li>from 04.2015</li> <li>from 04.2015</li> <li>from 04.2015</li> <li>from 04.2015</li> </ul>	<ul style="list-style-type: none"> <li>40492</li> <li>40556</li> <li>40524</li> <li>40494</li> <li>40558</li> <li>40526</li> <li>40510</li> <li>40574</li> <li>40542</li> <li>40508</li> <li>40572</li> <li>40540</li> </ul>	Quantity _____ _____ _____ _____ _____ _____ _____ _____ _____ _____ _____ _____	/each /each /each /each /each /each /each /each /each /each /each /each /each
	 <b>Side flap DSSR</b> <b>Width: 600 mm</b> <b>Dock shelter height: 3750 mm</b> <b>Right</b> <ul style="list-style-type: none"> <li>• Black / white</li> <li>• Grey / white</li> <li>• Blue / white</li> <li>• Black / yellow</li> <li>• Grey / yellow</li> <li>• Blue / yellow</li> <li>• Black / red</li> <li>• Grey / red</li> <li>• Blue / red</li> <li>• Black / orange</li> <li>• Grey / orange</li> <li>• Blue / orange</li> </ul>	<ul style="list-style-type: none"> <li>from 04.2015</li> <li>from 04.2015</li> <li>from 04.2015</li> <li>from 04.2015</li> <li>from 04.2015</li> <li>from 04.2015</li> <li>from 04.2015</li> <li>from 04.2015</li> <li>from 04.2015</li> <li>from 04.2015</li> <li>from 04.2015</li> <li>from 04.2015</li> </ul>	<ul style="list-style-type: none"> <li>40504</li> <li>40568</li> <li>40536</li> <li>40506</li> <li>40570</li> <li>40538</li> <li>40522</li> <li>40586</li> <li>40554</li> <li>40520</li> <li>40584</li> <li>40552</li> </ul>	Quantity _____ _____ _____ _____ _____ _____ _____ _____ _____ _____ _____ _____	/each /each /each /each /each /each /each /each /each /each /each /each /each
	<b>Side flap DSSR</b> <b>Width: 600 mm</b> <b>Dock shelter height: 3750 mm</b> <b>Left</b> <ul style="list-style-type: none"> <li>• Black / white</li> <li>• Grey / white</li> <li>• Blue / white</li> <li>• Black / yellow</li> <li>• Grey / yellow</li> <li>• Blue / yellow</li> <li>• Black / red</li> <li>• Grey / red</li> <li>• Blue / red</li> <li>• Black / orange</li> <li>• Grey / orange</li> <li>• Blue / orange</li> </ul>	<ul style="list-style-type: none"> <li>from 04.2015</li> <li>from 04.2015</li> <li>from 04.2015</li> <li>from 04.2015</li> <li>from 04.2015</li> <li>from 04.2015</li> <li>from 04.2015</li> <li>from 04.2015</li> <li>from 04.2015</li> <li>from 04.2015</li> <li>from 04.2015</li> <li>from 04.2015</li> </ul>	<ul style="list-style-type: none"> <li>40500</li> <li>40564</li> <li>40532</li> <li>40502</li> <li>40566</li> <li>40534</li> <li>40518</li> <li>40582</li> <li>40550</li> <li>40516</li> <li>40580</li> <li>40548</li> </ul>	Quantity _____ _____ _____ _____ _____ _____ _____ _____ _____ _____ _____ _____	/each /each /each /each /each /each /each /each /each /each /each /each /each

Image: on right

<b>ORDER</b>	Customer no.: _____	Order no./com.: _____	<b>Please take information from the data label!</b>	
	Customer name: _____	Shipping address: _____	Order no.:	Type:
	Place/date: _____	Stamp and signature _____	Dock shelter / seal no.:	Year of manufacture:
			Serial no.:	

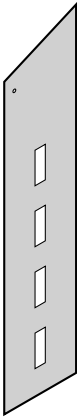

# Flap Shelters DS / DT

## Side flaps DTL / DTS

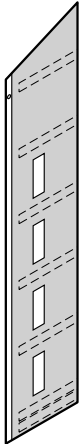
Article	Description	Production period	Art. no.	Quantity		
 <p>Image: on right</p>	<b>Side flaps DTL / DTS</b> <b>Width: 650 mm</b> <b>Dock shelter height: 3500 mm</b> <b>Right</b>			Quantity		
	<ul style="list-style-type: none"> <li>• Black / white</li> <li>• Grey / white</li> <li>• Blue / white</li> <li>• Black / yellow</li> <li>• Grey / yellow</li> <li>• Blue / yellow</li> <li>• Black / red</li> <li>• Grey / red</li> <li>• Blue / red</li> <li>• Black / orange</li> <li>• Grey / orange</li> <li>• Blue / orange</li> </ul>	<ul style="list-style-type: none"> <li>from 05.2005</li> <li>from 05.2005</li> <li>from 05.2005</li> <li>from 05.2005</li> <li>from 05.2005</li> <li>from 05.2005</li> <li>from 05.2005</li> <li>from 05.2005</li> <li>from 05.2005</li> <li>from 05.2005</li> <li>from 05.2005</li> <li>from 05.2005</li> </ul>	<ul style="list-style-type: none"> <li>2010273</li> <li>2010274</li> <li>2010275</li> <li>2010276</li> <li>2010277</li> <li>2010278</li> <li>2010279</li> <li>2010280</li> <li>2010281</li> <li>2010282</li> <li>2010283</li> <li>2010284</li> </ul>	<ul style="list-style-type: none"> <li>_____</li> <li>_____</li> <li>_____</li> <li>_____</li> <li>_____</li> <li>_____</li> <li>_____</li> <li>_____</li> <li>_____</li> <li>_____</li> <li>_____</li> <li>_____</li> </ul>	<ul style="list-style-type: none"> <li>/each</li> <li>/each</li> <li>/each</li> <li>/each</li> <li>/each</li> <li>/each</li> <li>/each</li> <li>/each</li> <li>/each</li> <li>/each</li> <li>/each</li> <li>/each</li> </ul>	
	<b>Side flaps DTL / DTS</b> <b>Width: 650 mm</b> <b>Dock shelter height: 3500 mm</b> <b>Left</b>				Quantity	
	<ul style="list-style-type: none"> <li>• Black / white</li> <li>• Grey / white</li> <li>• Blue / white</li> <li>• Black / yellow</li> <li>• Grey / yellow</li> <li>• Blue / yellow</li> <li>• Black / red</li> <li>• Grey / red</li> <li>• Blue / red</li> <li>• Black / orange</li> <li>• Grey / orange</li> <li>• Blue / orange</li> </ul>	<ul style="list-style-type: none"> <li>from 05.2005</li> <li>from 05.2005</li> <li>from 05.2005</li> <li>from 05.2005</li> <li>from 05.2005</li> <li>from 05.2005</li> <li>from 05.2005</li> <li>from 05.2005</li> <li>from 05.2005</li> <li>from 05.2005</li> <li>from 05.2005</li> <li>from 05.2005</li> </ul>	<ul style="list-style-type: none"> <li>2010285</li> <li>2010286</li> <li>2010287</li> <li>2010288</li> <li>2010289</li> <li>2010290</li> <li>2010291</li> <li>2010292</li> <li>2010293</li> <li>2010294</li> <li>2010295</li> <li>2010296</li> </ul>	<ul style="list-style-type: none"> <li>_____</li> <li>_____</li> <li>_____</li> <li>_____</li> <li>_____</li> <li>_____</li> <li>_____</li> <li>_____</li> <li>_____</li> <li>_____</li> <li>_____</li> <li>_____</li> </ul>	<ul style="list-style-type: none"> <li>/each</li> <li>/each</li> <li>/each</li> <li>/each</li> <li>/each</li> <li>/each</li> <li>/each</li> <li>/each</li> <li>/each</li> <li>/each</li> <li>/each</li> <li>/each</li> </ul>	

<b>ORDER</b>	Customer no.: _____	Order no./com.: _____	<b>Please take information from the data label!</b>	
			<b>Order no.:</b> _____	<b>Type:</b> _____
	Customer name: _____		<b>Dock shelter / seal no.:</b> _____	<b>Year of manufacture:</b> _____
	Shipping address: _____		<b>Serial no.:</b> _____	
	Place/date: _____		Stamp and signature _____	

# Flap Shelters DS / DT

## Side flaps DTL / DTS

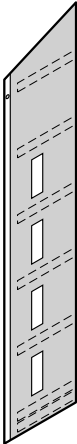
Article	Description	Production period	Art. no.	Quantity		
 <p>Image: on right</p>	<b>Side flaps DTL / DTS</b> <b>Width: 650 mm</b> <b>Dock shelter height: 3750 mm</b> <b>Right</b>			Quantity		
	<ul style="list-style-type: none"> <li>• Black / white from 05.2005 2010297 _____ /each</li> <li>• Grey / white from 05.2005 2010298 _____ /each</li> <li>• Blue / white from 05.2005 2010299 _____ /each</li> <li>• Black / yellow from 05.2005 2010300 _____ /each</li> <li>• Grey / yellow from 05.2005 2010301 _____ /each</li> <li>• Blue / yellow from 05.2005 2010302 _____ /each</li> <li>• Black / red from 05.2005 2010303 _____ /each</li> <li>• Grey / red from 05.2005 2010304 _____ /each</li> <li>• Blue / red from 05.2005 2010305 _____ /each</li> <li>• Black / orange from 05.2005 2010306 _____ /each</li> <li>• Grey / orange from 05.2005 2010307 _____ /each</li> <li>• Blue / orange from 05.2005 2010308 _____ /each</li> </ul>					
	<b>Side flaps DTL / DTS</b> <b>Width: 650 mm</b> <b>Dock shelter height: 3750 mm</b> <b>Left</b>				Quantity	
	<ul style="list-style-type: none"> <li>• Black / white from 05.2005 2010309 _____ /each</li> <li>• Grey / white from 05.2005 2010310 _____ /each</li> <li>• Blue / white from 05.2005 2010311 _____ /each</li> <li>• Black / yellow from 05.2005 2010312 _____ /each</li> <li>• Grey / yellow from 05.2005 2010313 _____ /each</li> <li>• Blue / yellow from 05.2005 2010314 _____ /each</li> <li>• Black / red from 05.2005 2010315 _____ /each</li> <li>• Grey / red from 05.2005 2010316 _____ /each</li> <li>• Blue / red from 05.2005 2010317 _____ /each</li> <li>• Black / orange from 05.2005 2010318 _____ /each</li> <li>• Grey / orange from 05.2005 2010319 _____ /each</li> <li>• Blue / orange from 05.2005 2010320 _____ /each</li> </ul>					

<b>ORDER</b>	Customer no.: _____ Order no./com.: _____	<b>Please take information from the data label!</b>	
	Customer name: _____	Order no.: _____	Type: _____
	Shipping address: _____	Dock shelter / seal no.: _____	Year of manufacture: _____
	Place/date: _____	Serial no.: _____	Stamp and signature _____

# Flap Shelters DS / DT

## Side flaps DTLR / DTSR

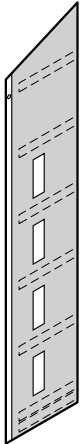
Article	Description	Production period	Art. no.	Quantity		
 <p>Image: on right</p>	<b>Side flaps DTLR / DTSR</b> <b>Width: 650 mm</b> <b>Dock shelter height: 3500 mm</b> <b>Right</b>			Quantity		
	<ul style="list-style-type: none"> <li>• Black / white</li> <li>• Grey / white</li> <li>• Blue / white</li> <li>• Black / yellow</li> <li>• Grey / yellow</li> <li>• Blue / yellow</li> <li>• Black / red</li> <li>• Grey / red</li> <li>• Blue / red</li> <li>• Black / orange</li> <li>• Grey / orange</li> <li>• Blue / orange</li> </ul>	<ul style="list-style-type: none"> <li>from 04.2015</li> <li>from 04.2015</li> <li>from 04.2015</li> <li>from 04.2015</li> <li>from 04.2015</li> <li>from 04.2015</li> <li>from 04.2015</li> <li>from 04.2015</li> <li>from 04.2015</li> <li>from 04.2015</li> <li>from 04.2015</li> <li>from 04.2015</li> </ul>	<ul style="list-style-type: none"> <li>40591</li> <li>40623</li> <li>40607</li> <li>40593</li> <li>40625</li> <li>40609</li> <li>40599</li> <li>40631</li> <li>40615</li> <li>40601</li> <li>40633</li> <li>40617</li> </ul>	<ul style="list-style-type: none"> <li>_____</li> <li>_____</li> <li>_____</li> <li>_____</li> <li>_____</li> <li>_____</li> <li>_____</li> <li>_____</li> <li>_____</li> <li>_____</li> <li>_____</li> <li>_____</li> </ul>	<ul style="list-style-type: none"> <li>/each</li> <li>/each</li> <li>/each</li> <li>/each</li> <li>/each</li> <li>/each</li> <li>/each</li> <li>/each</li> <li>/each</li> <li>/each</li> <li>/each</li> <li>/each</li> </ul>	
	<b>Side flaps DTLR / DTSR</b> <b>Width: 650 mm</b> <b>Dock shelter height: 3500 mm</b> <b>Left</b>				Quantity	
	<ul style="list-style-type: none"> <li>• Black / white</li> <li>• Grey / white</li> <li>• Blue / white</li> <li>• Black / yellow</li> <li>• Grey / yellow</li> <li>• Blue / yellow</li> <li>• Black / red</li> <li>• Grey / red</li> <li>• Blue / red</li> <li>• Black / orange</li> <li>• Grey / orange</li> <li>• Blue / orange</li> </ul>	<ul style="list-style-type: none"> <li>from 04.2015</li> <li>from 04.2015</li> <li>from 04.2015</li> <li>from 04.2015</li> <li>from 04.2015</li> <li>from 04.2015</li> <li>from 04.2015</li> <li>from 04.2015</li> <li>from 04.2015</li> <li>from 04.2015</li> <li>from 04.2015</li> <li>from 04.2015</li> </ul>	<ul style="list-style-type: none"> <li>40587</li> <li>40619</li> <li>40603</li> <li>40589</li> <li>40621</li> <li>40605</li> <li>40595</li> <li>40627</li> <li>40611</li> <li>40597</li> <li>40629</li> <li>40613</li> </ul>	<ul style="list-style-type: none"> <li>_____</li> <li>_____</li> <li>_____</li> <li>_____</li> <li>_____</li> <li>_____</li> <li>_____</li> <li>_____</li> <li>_____</li> <li>_____</li> <li>_____</li> <li>_____</li> </ul>	<ul style="list-style-type: none"> <li>/each</li> <li>/each</li> <li>/each</li> <li>/each</li> <li>/each</li> <li>/each</li> <li>/each</li> <li>/each</li> <li>/each</li> <li>/each</li> <li>/each</li> <li>/each</li> </ul>	

<b>ORDER</b>	Customer no.: _____	Order no./com.: _____	<b>Please take information from the data label!</b>	
			<b>Order no.:</b> _____	<b>Type:</b> _____
	Customer name: _____		<b>Dock shelter / seal no.:</b> _____	<b>Year of manufacture:</b> _____
	Shipping address: _____		<b>Serial no.:</b> _____	
	Place/date: _____		Stamp and signature _____	

# Flap Shelters DS / DT

## Side flaps DTLR / DTSR

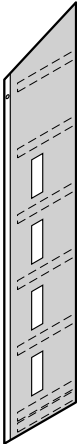
Article	Description	Production period	Art. no.	Quantity		
 <p>Image: on right</p>	<b>Side flaps DTLR / DTSR</b> <b>Width: 650 mm</b> <b>Dock shelter height: 3750 mm</b> <b>Right</b>			Quantity		
	<ul style="list-style-type: none"> <li>• Black / white</li> <li>• Grey / white</li> <li>• Blue / white</li> <li>• Black / yellow</li> <li>• Grey / yellow</li> <li>• Blue / yellow</li> <li>• Black / red</li> <li>• Grey / red</li> <li>• Blue / red</li> <li>• Black / orange</li> <li>• Grey / orange</li> <li>• Blue / orange</li> </ul>	<ul style="list-style-type: none"> <li>from 04.2015</li> <li>from 04.2015</li> <li>from 04.2015</li> <li>from 04.2015</li> <li>from 04.2015</li> <li>from 04.2015</li> <li>from 04.2015</li> <li>from 04.2015</li> <li>from 04.2015</li> <li>from 04.2015</li> <li>from 04.2015</li> <li>from 04.2015</li> </ul>	<ul style="list-style-type: none"> <li>40592</li> <li>40624</li> <li>40608</li> <li>40594</li> <li>40626</li> <li>40610</li> <li>40600</li> <li>40632</li> <li>40616</li> <li>40602</li> <li>40634</li> <li>40618</li> </ul>	<ul style="list-style-type: none"> <li>_____</li> <li>_____</li> <li>_____</li> <li>_____</li> <li>_____</li> <li>_____</li> <li>_____</li> <li>_____</li> <li>_____</li> <li>_____</li> <li>_____</li> <li>_____</li> </ul>	<ul style="list-style-type: none"> <li>/each</li> <li>/each</li> <li>/each</li> <li>/each</li> <li>/each</li> <li>/each</li> <li>/each</li> <li>/each</li> <li>/each</li> <li>/each</li> <li>/each</li> <li>/each</li> </ul>	
	<b>Side flaps DTLR / DTSR</b> <b>Width: 650 mm</b> <b>Dock shelter height: 3750 mm</b> <b>Left</b>				Quantity	
	<ul style="list-style-type: none"> <li>• Black / white</li> <li>• Grey / white</li> <li>• Blue / white</li> <li>• Black / yellow</li> <li>• Grey / yellow</li> <li>• Blue / yellow</li> <li>• Black / red</li> <li>• Grey / red</li> <li>• Blue / red</li> <li>• Black / orange</li> <li>• Grey / orange</li> <li>• Blue / orange</li> </ul>	<ul style="list-style-type: none"> <li>from 04.2015</li> <li>from 04.2015</li> <li>from 04.2015</li> <li>from 04.2015</li> <li>from 04.2015</li> <li>from 04.2015</li> <li>from 04.2015</li> <li>from 04.2015</li> <li>from 04.2015</li> <li>from 04.2015</li> <li>from 04.2015</li> <li>from 04.2015</li> </ul>	<ul style="list-style-type: none"> <li>40588</li> <li>40620</li> <li>40604</li> <li>40590</li> <li>40622</li> <li>40606</li> <li>40596</li> <li>40628</li> <li>40612</li> <li>40598</li> <li>40630</li> <li>40614</li> </ul>	<ul style="list-style-type: none"> <li>_____</li> <li>_____</li> <li>_____</li> <li>_____</li> <li>_____</li> <li>_____</li> <li>_____</li> <li>_____</li> <li>_____</li> <li>_____</li> <li>_____</li> <li>_____</li> </ul>	<ul style="list-style-type: none"> <li>/each</li> <li>/each</li> <li>/each</li> <li>/each</li> <li>/each</li> <li>/each</li> <li>/each</li> <li>/each</li> <li>/each</li> <li>/each</li> <li>/each</li> <li>/each</li> </ul>	

<b>ORDER</b>	Customer no.:	Order no./com.:	<b>Please take information from the data label!</b>	
	Customer name:	Dock shelter / seal no.:		Year of manufacture:
	Shipping address:	Serial no.:		
	Place/date:	Stamp and signature		

# Flap Shelters DS / DT

## Side flap DSS G

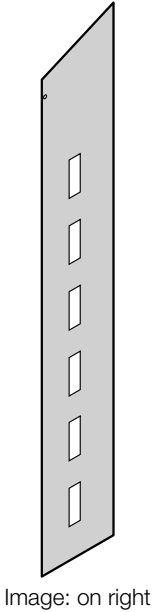
Article	Description	Production period	Art. no.	Quantity		
 <p>Image: on right</p>	<b>Side flap DSS G</b> <b>Width: 700 mm</b> <b>Dock shelter height: 4500 mm</b> <b>Right</b>			Quantity		
	<ul style="list-style-type: none"> <li>• Black / white</li> <li>• Grey / white</li> <li>• Blue / white</li> <li>• Black / yellow</li> <li>• Grey / yellow</li> <li>• Blue / yellow</li> <li>• Black / red</li> <li>• Grey / red</li> <li>• Blue / red</li> <li>• Black / orange</li> <li>• Grey / orange</li> <li>• Blue / orange</li> </ul>	<ul style="list-style-type: none"> <li>from 05.2005</li> <li>from 05.2005</li> <li>from 05.2005</li> <li>from 05.2005</li> <li>from 05.2005</li> <li>from 05.2005</li> <li>from 04.2015</li> <li>from 04.2015</li> <li>from 04.2015</li> <li>from 04.2015</li> <li>from 04.2015</li> <li>from 04.2015</li> </ul>	<ul style="list-style-type: none"> <li>2010321</li> <li>2010322</li> <li>2010323</li> <li>2010324</li> <li>2010325</li> <li>2010326</li> <li>40458</li> <li>40474</li> <li>40466</li> <li>40457</li> <li>40473</li> <li>40465</li> </ul>	<ul style="list-style-type: none"> <li>_____</li> <li>_____</li> <li>_____</li> <li>_____</li> <li>_____</li> <li>_____</li> <li>_____</li> <li>_____</li> <li>_____</li> <li>_____</li> <li>_____</li> <li>_____</li> </ul>	<ul style="list-style-type: none"> <li>/each</li> <li>/each</li> <li>/each</li> <li>/each</li> <li>/each</li> <li>/each</li> <li>/each</li> <li>/each</li> <li>/each</li> <li>/each</li> <li>/each</li> <li>/each</li> </ul>	
	<b>Side flap DSS G</b> <b>Width: 700 mm</b> <b>Dock shelter height: 4500 mm</b> <b>Left</b>				Quantity	
	<ul style="list-style-type: none"> <li>• Black / white</li> <li>• Grey / white</li> <li>• Blue / white</li> <li>• Black / yellow</li> <li>• Grey / yellow</li> <li>• Blue / yellow</li> <li>• Black / red</li> <li>• Grey / red</li> <li>• Blue / red</li> <li>• Black / orange</li> <li>• Grey / orange</li> <li>• Blue / orange</li> </ul>	<ul style="list-style-type: none"> <li>from 05.2005</li> <li>from 05.2005</li> <li>from 05.2005</li> <li>from 05.2005</li> <li>from 05.2005</li> <li>from 05.2005</li> <li>from 04.2015</li> <li>from 04.2015</li> <li>from 04.2015</li> <li>from 04.2015</li> <li>from 04.2015</li> <li>from 04.2015</li> </ul>	<ul style="list-style-type: none"> <li>2010327</li> <li>2010328</li> <li>2010329</li> <li>2010330</li> <li>2010331</li> <li>2010332</li> <li>40456</li> <li>40472</li> <li>40464</li> <li>40455</li> <li>40471</li> <li>40463</li> </ul>	<ul style="list-style-type: none"> <li>_____</li> <li>_____</li> <li>_____</li> <li>_____</li> <li>_____</li> <li>_____</li> <li>_____</li> <li>_____</li> <li>_____</li> <li>_____</li> <li>_____</li> <li>_____</li> </ul>	<ul style="list-style-type: none"> <li>/each</li> <li>/each</li> <li>/each</li> <li>/each</li> <li>/each</li> <li>/each</li> <li>/each</li> <li>/each</li> <li>/each</li> <li>/each</li> <li>/each</li> <li>/each</li> </ul>	

<b>ORDER</b>	Customer no.: _____	Order no./com.: _____	<b>Please take information from the data label!</b>	
			<b>Order no.:</b> _____	<b>Type:</b> _____
	Customer name: _____		<b>Dock shelter / seal no.:</b> _____	<b>Year of manufacture:</b> _____
	Shipping address: _____		<b>Serial no.:</b> _____	
	Place/date: _____		Stamp and signature _____	

# Flap Shelters DS / DT

## Side flap DSS G

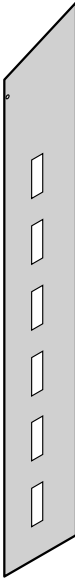
Article	Description	Production period	Art. no.	Quantity		
 <p>Image: on right</p>	<b>Side flap DSS G</b> <b>Width: 600 mm</b> <b>Dock shelter height: 4500 mm</b> <b>Right</b>			Quantity		
	<ul style="list-style-type: none"> <li>• Black / white</li> <li>• Grey / white</li> <li>• Blue / white</li> <li>• Black / yellow</li> <li>• Grey / yellow</li> <li>• Blue / yellow</li> <li>• Black / red</li> <li>• Grey / red</li> <li>• Blue / red</li> <li>• Black / orange</li> <li>• Grey / orange</li> <li>• Blue / orange</li> </ul>	<ul style="list-style-type: none"> <li>from 05.2005</li> <li>from 05.2005</li> <li>from 05.2005</li> <li>from 05.2005</li> <li>from 05.2005</li> <li>from 05.2005</li> <li>from 04.2015</li> <li>from 04.2015</li> <li>from 04.2015</li> <li>from 04.2015</li> <li>from 04.2015</li> <li>from 04.2015</li> </ul>	<ul style="list-style-type: none"> <li>2010333</li> <li>2010334</li> <li>2010335</li> <li>2010336</li> <li>2010337</li> <li>2010338</li> <li>40462</li> <li>40478</li> <li>40470</li> <li>40461</li> <li>40477</li> <li>40469</li> </ul>	<ul style="list-style-type: none"> <li>_____</li> <li>_____</li> <li>_____</li> <li>_____</li> <li>_____</li> <li>_____</li> <li>_____</li> <li>_____</li> <li>_____</li> <li>_____</li> <li>_____</li> <li>_____</li> </ul>	<ul style="list-style-type: none"> <li><b>/each</b></li> <li><b>/each</b></li> <li><b>/each</b></li> <li><b>/each</b></li> <li><b>/each</b></li> <li><b>/each</b></li> <li><b>/each</b></li> <li><b>/each</b></li> <li><b>/each</b></li> <li><b>/each</b></li> <li><b>/each</b></li> <li><b>/each</b></li> </ul>	
	<b>Side flap DSS G</b> <b>Width: 600 mm</b> <b>Dock shelter height: 4500 mm</b> <b>Left</b>				Quantity	
	<ul style="list-style-type: none"> <li>• Black / white</li> <li>• Grey / white</li> <li>• Blue / white</li> <li>• Black / yellow</li> <li>• Grey / yellow</li> <li>• Blue / yellow</li> <li>• Black / red</li> <li>• Grey / red</li> <li>• Blue / red</li> <li>• Black / orange</li> <li>• Grey / orange</li> <li>• Blue / orange</li> </ul>	<ul style="list-style-type: none"> <li>from 05.2005</li> <li>from 05.2005</li> <li>from 05.2005</li> <li>from 05.2005</li> <li>from 05.2005</li> <li>from 05.2005</li> <li>from 04.2015</li> <li>from 04.2015</li> <li>from 04.2015</li> <li>from 04.2015</li> <li>from 04.2015</li> <li>from 04.2015</li> </ul>	<ul style="list-style-type: none"> <li>2010339</li> <li>2010340</li> <li>2010341</li> <li>2010342</li> <li>2010343</li> <li>2010344</li> <li>40460</li> <li>40476</li> <li>40468</li> <li>40459</li> <li>40475</li> <li>40467</li> </ul>	<ul style="list-style-type: none"> <li>_____</li> <li>_____</li> <li>_____</li> <li>_____</li> <li>_____</li> <li>_____</li> <li>_____</li> <li>_____</li> <li>_____</li> <li>_____</li> <li>_____</li> <li>_____</li> </ul>	<ul style="list-style-type: none"> <li><b>/each</b></li> <li><b>/each</b></li> <li><b>/each</b></li> <li><b>/each</b></li> <li><b>/each</b></li> <li><b>/each</b></li> <li><b>/each</b></li> <li><b>/each</b></li> <li><b>/each</b></li> <li><b>/each</b></li> <li><b>/each</b></li> <li><b>/each</b></li> </ul>	

<b>ORDER</b>	Customer no.:	Order no./com.:	<b>Please take information from the data label!</b>	
	Customer name:	Shipping address:		Order no.:
	Shipping address:		Dock shelter / seal no.:	
	Shipping address:		Year of manufacture:	
	Shipping address:		Serial no.:	
Place/date:		Stamp and signature		

# Flap Shelters DS / DT

## Side flap DSSR G

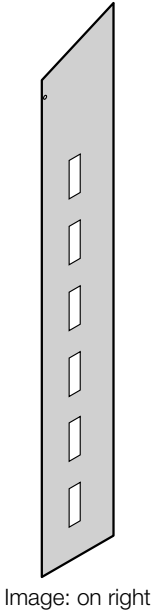
Article	Description	Production period	Art. no.	Quantity		
 <p>Image: on right</p>	<b>Side flap DSSR G</b> <b>Width: 700 mm</b> <b>Dock shelter height: 4500 mm</b> <b>Right</b>			Quantity		
	<ul style="list-style-type: none"> <li>• Black / white</li> <li>• Grey / white</li> <li>• Blue / white</li> <li>• Black / yellow</li> <li>• Grey / yellow</li> <li>• Blue / yellow</li> <li>• Black / red</li> <li>• Grey / red</li> <li>• Blue / red</li> <li>• Black / orange</li> <li>• Grey / orange</li> <li>• Blue / orange</li> </ul>	<ul style="list-style-type: none"> <li>from 04.2015</li> <li>from 04.2015</li> <li>from 04.2015</li> <li>from 04.2015</li> <li>from 04.2015</li> <li>from 04.2015</li> <li>from 04.2015</li> <li>from 04.2015</li> <li>from 04.2015</li> <li>from 04.2015</li> <li>from 04.2015</li> <li>from 04.2015</li> </ul>	<ul style="list-style-type: none"> <li>40637</li> <li>40669</li> <li>40653</li> <li>40638</li> <li>40670</li> <li>40654</li> <li>40646</li> <li>40678</li> <li>40662</li> <li>40645</li> <li>40677</li> <li>40661</li> </ul>	<ul style="list-style-type: none"> <li>_____</li> <li>_____</li> <li>_____</li> <li>_____</li> <li>_____</li> <li>_____</li> <li>_____</li> <li>_____</li> <li>_____</li> <li>_____</li> <li>_____</li> <li>_____</li> </ul>	<ul style="list-style-type: none"> <li>/each</li> <li>/each</li> <li>/each</li> <li>/each</li> <li>/each</li> <li>/each</li> <li>/each</li> <li>/each</li> <li>/each</li> <li>/each</li> <li>/each</li> <li>/each</li> </ul>	
	<b>Side flap DSSR G</b> <b>Width: 700 mm</b> <b>Dock shelter height: 4500 mm</b> <b>Left</b>				Quantity	
	<ul style="list-style-type: none"> <li>• Black / white</li> <li>• Grey / white</li> <li>• Blue / white</li> <li>• Black / yellow</li> <li>• Grey / yellow</li> <li>• Blue / yellow</li> <li>• Black / red</li> <li>• Grey / red</li> <li>• Blue / red</li> <li>• Black / orange</li> <li>• Grey / orange</li> <li>• Blue / orange</li> </ul>	<ul style="list-style-type: none"> <li>from 05.2005</li> <li>from 05.2005</li> <li>from 05.2005</li> <li>from 05.2005</li> <li>from 05.2005</li> <li>from 05.2005</li> <li>from 04.2015</li> <li>from 04.2015</li> <li>from 04.2015</li> <li>from 04.2015</li> <li>from 04.2015</li> <li>from 04.2015</li> </ul>	<ul style="list-style-type: none"> <li>40635</li> <li>40667</li> <li>40651</li> <li>40636</li> <li>40668</li> <li>40652</li> <li>40644</li> <li>40676</li> <li>40660</li> <li>40643</li> <li>40675</li> <li>40659</li> </ul>	<ul style="list-style-type: none"> <li>_____</li> <li>_____</li> <li>_____</li> <li>_____</li> <li>_____</li> <li>_____</li> <li>_____</li> <li>_____</li> <li>_____</li> <li>_____</li> <li>_____</li> <li>_____</li> </ul>	<ul style="list-style-type: none"> <li>/each</li> <li>/each</li> <li>/each</li> <li>/each</li> <li>/each</li> <li>/each</li> <li>/each</li> <li>/each</li> <li>/each</li> <li>/each</li> <li>/each</li> <li>/each</li> </ul>	

<b>ORDER</b>	Customer no.: _____	Order no./com.: _____	<b>Please take information from the data label!</b>	
			<b>Order no.:</b> _____	<b>Type:</b> _____
	Customer name: _____		<b>Dock shelter / seal no.:</b> _____	<b>Year of manufacture:</b> _____
	Shipping address: _____		<b>Serial no.:</b> _____	
	Place/date: _____		Stamp and signature _____	

# Flap Shelters DS / DT

## Side flap DSSR G

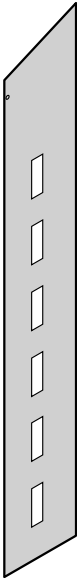
Article	Description	Production period	Art. no.	Quantity		
 <p>Image: on right</p>	<b>Side flap DSSR G</b> <b>Width: 600 mm</b> <b>Dock shelter height: 4500 mm</b> <b>Right</b>			Quantity		
	<ul style="list-style-type: none"> <li>• Black / white</li> <li>• Grey / white</li> <li>• Blue / white</li> <li>• Black / yellow</li> <li>• Grey / yellow</li> <li>• Blue / yellow</li> <li>• Black / red</li> <li>• Grey / red</li> <li>• Blue / red</li> <li>• Black / orange</li> <li>• Grey / orange</li> <li>• Blue / orange</li> </ul>	<ul style="list-style-type: none"> <li>from 04.2015</li> <li>from 04.2015</li> <li>from 04.2015</li> <li>from 04.2015</li> <li>from 04.2015</li> <li>from 04.2015</li> <li>from 04.2015</li> <li>from 04.2015</li> <li>from 04.2015</li> <li>from 04.2015</li> <li>from 04.2015</li> <li>from 04.2015</li> </ul>	<ul style="list-style-type: none"> <li>40641</li> <li>40673</li> <li>40657</li> <li>40642</li> <li>40674</li> <li>40658</li> <li>40650</li> <li>40682</li> <li>40666</li> <li>40649</li> <li>40681</li> <li>40665</li> </ul>	<ul style="list-style-type: none"> <li>_____</li> <li>_____</li> <li>_____</li> <li>_____</li> <li>_____</li> <li>_____</li> <li>_____</li> <li>_____</li> <li>_____</li> <li>_____</li> <li>_____</li> <li>_____</li> </ul>	<ul style="list-style-type: none"> <li>/each</li> <li>/each</li> <li>/each</li> <li>/each</li> <li>/each</li> <li>/each</li> <li>/each</li> <li>/each</li> <li>/each</li> <li>/each</li> <li>/each</li> <li>/each</li> </ul>	
	<b>Side flap DSSR G</b> <b>Width: 600 mm</b> <b>Dock shelter height: 4500 mm</b> <b>Left</b>				Quantity	
	<ul style="list-style-type: none"> <li>• Black / white</li> <li>• Grey / white</li> <li>• Blue / white</li> <li>• Black / yellow</li> <li>• Grey / yellow</li> <li>• Blue / yellow</li> <li>• Black / red</li> <li>• Grey / red</li> <li>• Blue / red</li> <li>• Black / orange</li> <li>• Grey / orange</li> <li>• Blue / orange</li> </ul>	<ul style="list-style-type: none"> <li>from 05.2005</li> <li>from 05.2005</li> <li>from 05.2005</li> <li>from 05.2005</li> <li>from 05.2005</li> <li>from 05.2005</li> <li>from 04.2015</li> <li>from 04.2015</li> <li>from 04.2015</li> <li>from 04.2015</li> <li>from 04.2015</li> <li>from 04.2015</li> </ul>	<ul style="list-style-type: none"> <li>40639</li> <li>40671</li> <li>40655</li> <li>40640</li> <li>40672</li> <li>40656</li> <li>40648</li> <li>40680</li> <li>40664</li> <li>40647</li> <li>40679</li> <li>40663</li> </ul>	<ul style="list-style-type: none"> <li>_____</li> <li>_____</li> <li>_____</li> <li>_____</li> <li>_____</li> <li>_____</li> <li>_____</li> <li>_____</li> <li>_____</li> <li>_____</li> <li>_____</li> <li>_____</li> </ul>	<ul style="list-style-type: none"> <li>/each</li> <li>/each</li> <li>/each</li> <li>/each</li> <li>/each</li> <li>/each</li> <li>/each</li> <li>/each</li> <li>/each</li> <li>/each</li> <li>/each</li> <li>/each</li> </ul>	

<b>ORDER</b>	Customer no.: _____	Order no./com.: _____	<b>Please take information from the data label!</b>	
	Customer name: _____	Shipping address: _____	Order no.:	Type:
	Shipping address: _____	Place/date: _____	Dock shelter / seal no.:	Year of manufacture:
			Serial no.:	
			Stamp and signature	



# Flap Shelters DS / DT

## Side flap DTS G

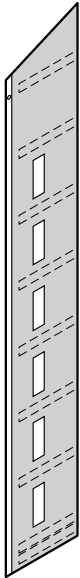
Article	Description	Production period	Art. no.	Quantity		
 <p>Image: on right</p>	<b>Side flap DTS G</b> <b>Width: 650 mm</b> <b>Dock shelter height: 4500 mm</b> <b>Right</b>			Quantity		
	<ul style="list-style-type: none"> <li>• Black / white</li> <li>• Grey / white</li> <li>• Blue / white</li> <li>• Black / yellow</li> <li>• Grey / yellow</li> <li>• Blue / yellow</li> <li>• Black / red</li> <li>• Grey / red</li> <li>• Blue / red</li> <li>• Black / orange</li> <li>• Grey / orange</li> <li>• Blue / orange</li> </ul>	<ul style="list-style-type: none"> <li>from 05.2005</li> <li>from 05.2005</li> <li>from 05.2005</li> <li>from 05.2005</li> <li>from 05.2005</li> <li>from 05.2005</li> <li>from 05.2005</li> <li>from 05.2005</li> <li>from 05.2005</li> <li>from 05.2005</li> <li>from 05.2005</li> <li>from 05.2005</li> </ul>	<ul style="list-style-type: none"> <li>2010345</li> <li>2010346</li> <li>2010347</li> <li>2010348</li> <li>2010349</li> <li>2010350</li> <li>2010351</li> <li>2010352</li> <li>2010353</li> <li>2010354</li> <li>2010355</li> <li>2010356</li> </ul>	<ul style="list-style-type: none"> <li>_____</li> <li>_____</li> <li>_____</li> <li>_____</li> <li>_____</li> <li>_____</li> <li>_____</li> <li>_____</li> <li>_____</li> <li>_____</li> <li>_____</li> <li>_____</li> </ul>	<ul style="list-style-type: none"> <li>/each</li> <li>/each</li> <li>/each</li> <li>/each</li> <li>/each</li> <li>/each</li> <li>/each</li> <li>/each</li> <li>/each</li> <li>/each</li> <li>/each</li> <li>/each</li> </ul>	
	<b>Side flap DTS G</b> <b>Width: 650 mm</b> <b>Dock shelter height: 4500 mm</b> <b>Left</b>				Quantity	
	<ul style="list-style-type: none"> <li>• Black / white</li> <li>• Grey / white</li> <li>• Blue / white</li> <li>• Black / yellow</li> <li>• Grey / yellow</li> <li>• Blue / yellow</li> <li>• Black / red</li> <li>• Grey / red</li> <li>• Blue / red</li> <li>• Black / orange</li> <li>• Grey / orange</li> <li>• Blue / orange</li> </ul>	<ul style="list-style-type: none"> <li>from 05.2005</li> <li>from 05.2005</li> <li>from 05.2005</li> <li>from 05.2005</li> <li>from 05.2005</li> <li>from 05.2005</li> <li>from 05.2005</li> <li>from 05.2005</li> <li>from 05.2005</li> <li>from 05.2005</li> <li>from 05.2005</li> <li>from 05.2005</li> </ul>	<ul style="list-style-type: none"> <li>2010357</li> <li>2010358</li> <li>2010359</li> <li>2010360</li> <li>2010361</li> <li>2010362</li> <li>2010363</li> <li>2010364</li> <li>2010365</li> <li>2010366</li> <li>2010367</li> <li>2010368</li> </ul>	<ul style="list-style-type: none"> <li>_____</li> <li>_____</li> <li>_____</li> <li>_____</li> <li>_____</li> <li>_____</li> <li>_____</li> <li>_____</li> <li>_____</li> <li>_____</li> <li>_____</li> <li>_____</li> </ul>	<ul style="list-style-type: none"> <li>/each</li> <li>/each</li> <li>/each</li> <li>/each</li> <li>/each</li> <li>/each</li> <li>/each</li> <li>/each</li> <li>/each</li> <li>/each</li> <li>/each</li> <li>/each</li> </ul>	

<b>ORDER</b>	Customer no.: _____	Order no./com.: _____	<b>Please take information from the data label!</b>	
	Customer name: _____	Shipping address: _____	<b>Order no.:</b> _____	<b>Type:</b> _____
	Place/date: _____	Stamp and signature _____	<b>Dock shelter / seal no.:</b> _____	<b>Year of manufacture:</b> _____
			<b>Serial no.:</b> _____	

# Flap Shelters DS / DT

## Side flaps DTLR G / DTSR G

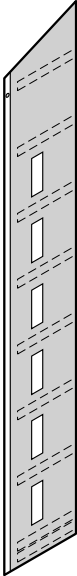
Article	Description	Production period	Art. no.	Quantity		
 <p>Image: on right</p>	<b>Side flaps DTLR G / DTSR G</b> <b>Width: 650 mm</b> <b>Dock shelter height: 4500 mm</b> <b>Right</b>			Quantity		
	<ul style="list-style-type: none"> <li>• Black / white from 04.2015 40685 _____ /each</li> <li>• Grey / white from 04.2015 40701 _____ /each</li> <li>• Blue / white from 04.2015 40693 _____ /each</li> <li>• Black / yellow from 04.2015 40686 _____ /each</li> <li>• Grey / yellow from 04.2015 40702 _____ /each</li> <li>• Blue / yellow from 04.2015 40694 _____ /each</li> <li>• Black / red from 04.2015 40689 _____ /each</li> <li>• Grey / red from 04.2015 40705 _____ /each</li> <li>• Blue / red from 04.2015 40697 _____ /each</li> <li>• Black / orange from 04.2015 40690 _____ /each</li> <li>• Grey / orange from 04.2015 40706 _____ /each</li> <li>• Blue / orange from 04.2015 40698 _____ /each</li> </ul>					
	<b>Side flaps DTLR G / DTSR G</b> <b>Width: 650 mm</b> <b>Dock shelter height: 4500 mm</b> <b>Left</b>				Quantity	
	<ul style="list-style-type: none"> <li>• Black / white from 05.2005 40683 _____ /each</li> <li>• Grey / white from 05.2005 40699 _____ /each</li> <li>• Blue / white from 05.2005 40691 _____ /each</li> <li>• Black / yellow from 05.2005 40684 _____ /each</li> <li>• Grey / yellow from 05.2005 40700 _____ /each</li> <li>• Blue / yellow from 05.2005 40692 _____ /each</li> <li>• Black / red from 04.2015 40687 _____ /each</li> <li>• Grey / red from 04.2015 40703 _____ /each</li> <li>• Blue / red from 04.2015 40695 _____ /each</li> <li>• Black / orange from 04.2015 40688 _____ /each</li> <li>• Grey / orange from 04.2015 40704 _____ /each</li> <li>• Blue / orange from 04.2015 40696 _____ /each</li> </ul>					

<b>ORDER</b>	Customer no.: _____ Order no./com.: _____	<b>Please take information from the data label!</b>	
	Customer name: _____	Order no.: _____	Type: _____
	Shipping address: _____	Dock shelter / seal no.: _____	Year of manufacture: _____
	Place/date: _____	Serial no.: _____	
		Stamp and signature _____	

# Flap Shelters DS / DT

## Side flap DSN

Article	Description	Production period	Art. no.	Quantity	
 <p>Image: on right</p>	<b>Side flap DSN</b> <b>Width: 700 mm</b> <b>Dock shelter height: 3500 mm</b> <b>Right</b> <ul style="list-style-type: none"> <li>• Black / white</li> <li>• Grey / white</li> <li>• Blue / white</li> <li>• Black / yellow</li> <li>• Grey / yellow</li> <li>• Blue / yellow</li> <li>• Black / red</li> <li>• Grey / red</li> <li>• Blue / red</li> <li>• Black / orange</li> <li>• Grey / orange</li> <li>• Blue / orange</li> </ul>	from 05.2005 from 05.2005 from 05.2005 from 05.2005 from 05.2005 from 05.2005 from 05.2005 from 05.2005 from 05.2005 from 05.2005 from 05.2005 from 05.2005 from 05.2005	2010369 2010370 2010371 2010372 2010373 2010374 40340 40373 40357 40338 40371 40355	_____ _____ _____ _____ _____ _____ _____ _____ _____ _____ _____ _____	/each /each /each /each /each /each /each /each /each /each /each /each
	<b>Side flap DSN</b> <b>Width: 700 mm</b> <b>Dock shelter height: 3500 mm</b> <b>Left</b> <ul style="list-style-type: none"> <li>• Black / white</li> <li>• Grey / white</li> <li>• Blue / white</li> <li>• Black / yellow</li> <li>• Grey / yellow</li> <li>• Blue / yellow</li> <li>• Black / red</li> <li>• Grey / red</li> <li>• Blue / red</li> <li>• Black / orange</li> <li>• Grey / orange</li> <li>• Blue / orange</li> </ul>	from 05.2005 from 05.2005 from 05.2005 from 05.2005 from 05.2005 from 05.2005 from 05.2005 from 05.2005 from 05.2005 from 05.2005 from 05.2005 from 05.2005 from 05.2005	2010375 2010376 2010377 2010378 2010379 2010380 40336 40369 40352 40334 40367 40350	_____ _____ _____ _____ _____ _____ _____ _____ _____ _____ _____	/each /each /each /each /each /each /each /each /each /each /each /each
	<b>Side flap DSN</b> <b>Width: 600 mm</b> <b>Dock shelter height: 3500 mm</b> <b>Right</b> <ul style="list-style-type: none"> <li>• Black / white</li> <li>• Grey / white</li> <li>• Blue / white</li> <li>• Black / yellow</li> <li>• Grey / yellow</li> <li>• Blue / yellow</li> <li>• Black / red</li> <li>• Grey / red</li> <li>• Blue / red</li> <li>• Black / orange</li> <li>• Grey / orange</li> <li>• Blue / orange</li> </ul>	from 05.2005 from 05.2005 from 05.2005 from 05.2005 from 05.2005 from 05.2005 from 05.2005 from 05.2005 from 05.2005 from 05.2005 from 05.2005 from 05.2005 from 05.2005	2010381 2010382 2010383 2010384 2010385 2010386 40348 40381 40365 40346 40379 40363	_____ _____ _____ _____ _____ _____ _____ _____ _____ _____ _____	/each /each /each /each /each /each /each /each /each /each /each /each

<b>ORDER</b>	Customer no.: _____	Order no./com.: _____	<b>Please take information from the data label!</b>	
			<b>Order no.:</b> _____	<b>Type:</b> _____
	Customer name: _____		<b>Dock shelter / seal no.:</b> _____	<b>Year of manufacture:</b> _____
	Shipping address: _____		<b>Serial no.:</b> _____	
	Place/date: _____		Stamp and signature _____	

# Flap Shelters DS / DT

## Side flap DSN

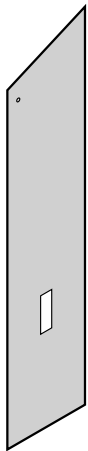
Article	Description	Production period	Art. no.	Quantity	
	<b>Side flap DSN</b> <b>Width: 600 mm</b> <b>Dock shelter height: 3500 mm</b> <b>Left</b>			Quantity	
	• Black / white	from 05.2005	2010387	_____	/each
	• Grey / white	from 05.2005	2010388	_____	/each
	• Blue / white	from 05.2005	2010389	_____	/each
	• Black / yellow	from 05.2005	2010390	_____	/each
	• Grey / yellow	from 05.2005	2010391	_____	/each
	• Blue / yellow	from 05.2005	2010392	_____	/each
	• Black / red	from 05.2005	40344	_____	/each
	• Grey / red	from 05.2005	40377	_____	/each
	• Blue / red	from 05.2005	40361	_____	/each
	• Black / orange	from 05.2005	40342	_____	/each
	• Grey / orange	from 05.2005	40375	_____	/each
	• Blue / orange	from 05.2005	40359	_____	/each
 Image: on right	<b>Side flap DSN</b> <b>Width: 700 mm</b> <b>Dock shelter height: 3750 mm</b> <b>Right</b>			Quantity	
	• Black / white	from 05.2005	2010393	_____	/each
	• Grey / white	from 05.2005	2010394	_____	/each
	• Blue / white	from 05.2005	2010395	_____	/each
	• Black / yellow	from 05.2005	2010396	_____	/each
	• Grey / yellow	from 05.2005	2010397	_____	/each
	• Blue / yellow	from 05.2005	2010398	_____	/each
	• Black / red	from 05.2005	40341	_____	/each
	• Grey / red	from 05.2005	40374	_____	/each
	• Blue / red	from 05.2005	40358	_____	/each
	• Black / orange	from 05.2005	40339	_____	/each
	• Grey / orange	from 05.2005	40372	_____	/each
	• Blue / orange	from 05.2005	40356	_____	/each
	<b>Side flap DSN</b> <b>Width: 700 mm</b> <b>Dock shelter height: 3750 mm</b> <b>Left</b>			Quantity	
	• Black / white	from 05.2005	2010399	_____	/each
	• Grey / white	from 05.2005	2010400	_____	/each
	• Blue / white	from 05.2005	2010401	_____	/each
	• Black / yellow	from 05.2005	2010402	_____	/each
	• Grey / yellow	from 05.2005	2010403	_____	/each
	• Blue / yellow	from 05.2005	2010404	_____	/each
	• Black / red	from 05.2005	40337	_____	/each
	• Grey / red	from 05.2005	40370	_____	/each
	• Blue / red	from 05.2005	40353	_____	/each
	• Black / orange	from 05.2005	40335	_____	/each
	• Grey / orange	from 05.2005	40368	_____	/each
	• Blue / orange	from 05.2005	40351	_____	/each

<b>ORDER</b>	Customer no.:	Order no./com.:	<b>Please take information from the data label!</b>	
	Customer name:	Shipping address:	<b>Order no.:</b>	<b>Type:</b>
	Place/date:	Stamp and signature	<b>Dock shelter / seal no.:</b>	<b>Year of manufacture:</b>
			<b>Serial no.:</b>	

# Flap Shelters DS / DT

## Side flap DSN

Article	Description	Production period	Art. no.	Quantity		
 <p>Image: on right</p>	<b>Side flap DSN</b> <b>Width: 600 mm</b> <b>Dock shelter height: 3750 mm</b> <b>Right</b>			Quantity		
	<ul style="list-style-type: none"> <li>• Black / white</li> <li>• Grey / white</li> <li>• Blue / white</li> <li>• Black / yellow</li> <li>• Grey / yellow</li> <li>• Blue / yellow</li> <li>• Black / red</li> <li>• Grey / red</li> <li>• Blue / red</li> <li>• Black / orange</li> <li>• Grey / orange</li> <li>• Blue / orange</li> </ul>	<ul style="list-style-type: none"> <li>from 05.2005</li> <li>from 05.2005</li> <li>from 05.2005</li> <li>from 05.2005</li> <li>from 05.2005</li> <li>from 05.2005</li> <li>from 05.2005</li> <li>from 05.2005</li> <li>from 05.2005</li> <li>from 05.2005</li> <li>from 05.2005</li> <li>from 05.2005</li> </ul>	<ul style="list-style-type: none"> <li>2010405</li> <li>2010406</li> <li>2010407</li> <li>2010408</li> <li>2010409</li> <li>2010410</li> <li>40349</li> <li>40382</li> <li>40366</li> <li>40347</li> <li>40380</li> <li>40364</li> </ul>	<ul style="list-style-type: none"> <li>_____</li> <li>_____</li> <li>_____</li> <li>_____</li> <li>_____</li> <li>_____</li> <li>_____</li> <li>_____</li> <li>_____</li> <li>_____</li> <li>_____</li> <li>_____</li> </ul>	<ul style="list-style-type: none"> <li>/each</li> <li>/each</li> <li>/each</li> <li>/each</li> <li>/each</li> <li>/each</li> <li>/each</li> <li>/each</li> <li>/each</li> <li>/each</li> <li>/each</li> <li>/each</li> </ul>	
	<b>Side flap DSN</b> <b>Width: 600 mm</b> <b>Dock shelter height: 3750 mm</b> <b>Left</b>				Quantity	
	<ul style="list-style-type: none"> <li>• Black / white</li> <li>• Grey / white</li> <li>• Blue / white</li> <li>• Black / yellow</li> <li>• Grey / yellow</li> <li>• Blue / yellow</li> <li>• Black / red</li> <li>• Grey / red</li> <li>• Blue / red</li> <li>• Black / orange</li> <li>• Grey / orange</li> <li>• Blue / orange</li> </ul>	<ul style="list-style-type: none"> <li>from 05.2005</li> <li>from 05.2005</li> <li>from 05.2005</li> <li>from 05.2005</li> <li>from 05.2005</li> <li>from 05.2005</li> <li>from 05.2005</li> <li>from 05.2005</li> <li>from 05.2005</li> <li>from 05.2005</li> <li>from 05.2005</li> <li>from 05.2005</li> </ul>	<ul style="list-style-type: none"> <li>2010411</li> <li>2010412</li> <li>2010413</li> <li>2010414</li> <li>2010415</li> <li>2010416</li> <li>40345</li> <li>40378</li> <li>40362</li> <li>40343</li> <li>40376</li> <li>40360</li> </ul>	<ul style="list-style-type: none"> <li>_____</li> <li>_____</li> <li>_____</li> <li>_____</li> <li>_____</li> <li>_____</li> <li>_____</li> <li>_____</li> <li>_____</li> <li>_____</li> <li>_____</li> <li>_____</li> </ul>	<ul style="list-style-type: none"> <li>/each</li> <li>/each</li> <li>/each</li> <li>/each</li> <li>/each</li> <li>/each</li> <li>/each</li> <li>/each</li> <li>/each</li> <li>/each</li> <li>/each</li> <li>/each</li> </ul>	

<b>ORDER</b>	Customer no.: _____	Order no./com.: _____	<b>Please take information from the data label!</b>	
			<b>Order no.:</b> _____	<b>Type:</b> _____
	Customer name: _____		<b>Dock shelter / seal no.:</b> _____	<b>Year of manufacture:</b> _____
	Shipping address: _____		<b>Serial no.:</b> _____	
	Place/date: _____		Stamp and signature _____	

# Flap Shelters DS / DT

## Side flap DSN G

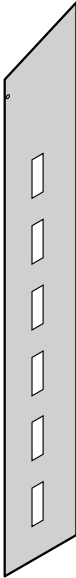
Article	Description	Production period	Art. no.	Quantity		
 <p>Image: on right</p>	<b>Side flap DSN G</b> <b>Width: 700 mm</b> <b>Dock shelter height: 4500 mm</b> <b>Right</b>			Quantity		
	<ul style="list-style-type: none"> <li>• Black / white</li> <li>• Grey / white</li> <li>• Blue / white</li> <li>• Black / yellow</li> <li>• Grey / yellow</li> <li>• Blue / yellow</li> <li>• Black / red</li> <li>• Grey / red</li> <li>• Blue / red</li> <li>• Black / orange</li> <li>• Grey / orange</li> <li>• Blue / orange</li> </ul>	<ul style="list-style-type: none"> <li>from 05.2005</li> <li>from 05.2005</li> <li>from 05.2005</li> <li>from 05.2005</li> <li>from 05.2005</li> <li>from 05.2005</li> <li>from 05.2005</li> <li>from 05.2005</li> <li>from 05.2005</li> <li>from 05.2005</li> <li>from 05.2005</li> <li>from 05.2005</li> </ul>	<ul style="list-style-type: none"> <li>2010417</li> <li>2010418</li> <li>2010419</li> <li>2010420</li> <li>2010421</li> <li>2010422</li> <li>40434</li> <li>40450</li> <li>40442</li> <li>40433</li> <li>40449</li> <li>40441</li> </ul>	<ul style="list-style-type: none"> <li>_____</li> <li>_____</li> <li>_____</li> <li>_____</li> <li>_____</li> <li>_____</li> <li>_____</li> <li>_____</li> <li>_____</li> <li>_____</li> <li>_____</li> <li>_____</li> </ul>	<ul style="list-style-type: none"> <li><b>/each</b></li> <li><b>/each</b></li> <li><b>/each</b></li> <li><b>/each</b></li> <li><b>/each</b></li> <li><b>/each</b></li> <li><b>/each</b></li> <li><b>/each</b></li> <li><b>/each</b></li> <li><b>/each</b></li> <li><b>/each</b></li> <li><b>/each</b></li> </ul>	
	<b>Side flap DSN G</b> <b>Width: 700 mm</b> <b>Dock shelter height: 4500 mm</b> <b>Left</b>				Quantity	
	<ul style="list-style-type: none"> <li>• Black / white</li> <li>• Grey / white</li> <li>• Blue / white</li> <li>• Black / yellow</li> <li>• Grey / yellow</li> <li>• Blue / yellow</li> <li>• Black / red</li> <li>• Grey / red</li> <li>• Blue / red</li> <li>• Black / orange</li> <li>• Grey / orange</li> <li>• Blue / orange</li> </ul>	<ul style="list-style-type: none"> <li>from 05.2005</li> <li>from 05.2005</li> <li>from 05.2005</li> <li>from 05.2005</li> <li>from 05.2005</li> <li>from 05.2005</li> <li>from 05.2005</li> <li>from 05.2005</li> <li>from 05.2005</li> <li>from 05.2005</li> <li>from 05.2005</li> <li>from 05.2005</li> </ul>	<ul style="list-style-type: none"> <li>2010423</li> <li>2010424</li> <li>2010425</li> <li>2010426</li> <li>2010427</li> <li>2010428</li> <li>40432</li> <li>40448</li> <li>40440</li> <li>40431</li> <li>40447</li> <li>40439</li> </ul>	<ul style="list-style-type: none"> <li>_____</li> <li>_____</li> <li>_____</li> <li>_____</li> <li>_____</li> <li>_____</li> <li>_____</li> <li>_____</li> <li>_____</li> <li>_____</li> <li>_____</li> <li>_____</li> </ul>	<ul style="list-style-type: none"> <li><b>/each</b></li> <li><b>/each</b></li> <li><b>/each</b></li> <li><b>/each</b></li> <li><b>/each</b></li> <li><b>/each</b></li> <li><b>/each</b></li> <li><b>/each</b></li> <li><b>/each</b></li> <li><b>/each</b></li> <li><b>/each</b></li> <li><b>/each</b></li> </ul>	

<b>ORDER</b>	Customer no.: _____ Order no./com.: _____	<b>Please take information from the data label!</b>	
	Customer name: _____	Order no.: _____	Type: _____
	Shipping address: _____	Dock shelter / seal no.: _____	Year of manufacture: _____
	Place/date: _____	Serial no.: _____	
		Stamp and signature _____	

# Flap Shelters DS / DT

## Side flap DSN G

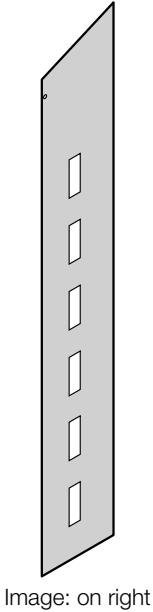
Article	Description	Production period	Art. no.	Quantity		
 <p>Image: on right</p>	<b>Side flap DSN G</b> <b>Width: 600 mm</b> <b>Dock shelter height: 4500 mm</b> <b>Right</b>			Quantity		
	<ul style="list-style-type: none"> <li>• Black / white</li> <li>• Grey / white</li> <li>• Blue / white</li> <li>• Black / yellow</li> <li>• Grey / yellow</li> <li>• Blue / yellow</li> <li>• Black / red</li> <li>• Grey / red</li> <li>• Blue / red</li> <li>• Black / orange</li> <li>• Grey / orange</li> <li>• Blue / orange</li> </ul>	<ul style="list-style-type: none"> <li>from 05.2005</li> <li>from 05.2005</li> <li>from 05.2005</li> <li>from 05.2005</li> <li>from 05.2005</li> <li>from 05.2005</li> <li>from 05.2005</li> <li>from 05.2005</li> <li>from 05.2005</li> <li>from 05.2005</li> <li>from 05.2005</li> <li>from 05.2005</li> </ul>	<ul style="list-style-type: none"> <li>2010429</li> <li>2010430</li> <li>2010431</li> <li>2010432</li> <li>2010433</li> <li>2010434</li> <li>40438</li> <li>40454</li> <li>40446</li> <li>40437</li> <li>40453</li> <li>40445</li> </ul>	<ul style="list-style-type: none"> <li>_____</li> <li>_____</li> <li>_____</li> <li>_____</li> <li>_____</li> <li>_____</li> <li>_____</li> <li>_____</li> <li>_____</li> <li>_____</li> <li>_____</li> <li>_____</li> </ul>	<ul style="list-style-type: none"> <li>/each</li> <li>/each</li> <li>/each</li> <li>/each</li> <li>/each</li> <li>/each</li> <li>/each</li> <li>/each</li> <li>/each</li> <li>/each</li> <li>/each</li> <li>/each</li> </ul>	
	<b>Side flap DSN G</b> <b>Width: 600 mm</b> <b>Dock shelter height: 4500 mm</b> <b>Left</b>				Quantity	
	<ul style="list-style-type: none"> <li>• Black / white</li> <li>• Grey / white</li> <li>• Blue / white</li> <li>• Black / yellow</li> <li>• Grey / yellow</li> <li>• Blue / yellow</li> <li>• Black / red</li> <li>• Grey / red</li> <li>• Blue / red</li> <li>• Black / orange</li> <li>• Grey / orange</li> <li>• Blue / orange</li> </ul>	<ul style="list-style-type: none"> <li>from 05.2005</li> <li>from 05.2005</li> <li>from 05.2005</li> <li>from 05.2005</li> <li>from 05.2005</li> <li>from 05.2005</li> <li>from 05.2005</li> <li>from 05.2005</li> <li>from 05.2005</li> <li>from 05.2005</li> <li>from 05.2005</li> <li>from 05.2005</li> </ul>	<ul style="list-style-type: none"> <li>2010435</li> <li>2010439</li> <li>2010437</li> <li>2010438</li> <li>308023</li> <li>2010440</li> <li>40436</li> <li>40452</li> <li>40444</li> <li>40435</li> <li>40451</li> <li>40443</li> </ul>	<ul style="list-style-type: none"> <li>_____</li> <li>_____</li> <li>_____</li> <li>_____</li> <li>_____</li> <li>_____</li> <li>_____</li> <li>_____</li> <li>_____</li> <li>_____</li> <li>_____</li> <li>_____</li> </ul>	<ul style="list-style-type: none"> <li>/each</li> <li>/each</li> <li>/each</li> <li>/each</li> <li>/each</li> <li>/each</li> <li>/each</li> <li>/each</li> <li>/each</li> <li>/each</li> <li>/each</li> <li>/each</li> </ul>	

<b>ORDER</b>	Customer no.: _____ Order no./com.: _____	<b>Please take information from the data label!</b>	
	Customer name: _____	Order no.: _____	Type: _____
	Shipping address: _____	Dock shelter / seal no.: _____	Year of manufacture: _____
	Place/date: _____	Serial no.: _____	
		Stamp and signature _____	

# Flap Shelters DS / DT

## Top flap DSL (G) / DSS (G) / DSLR (G) / DSSR (G) with Hörmann logo

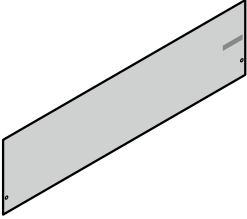
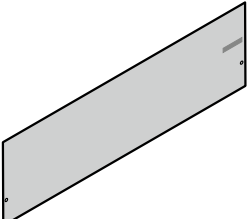
Article	Description	Production period	Art. no.	Quantity	
	<b>Top flap DSL (G) / DSS (G) / DSLR (G) / DSSR (G) Height 900 mm</b>			Quantity	
	<b>Dock shelter width 2800 mm</b>				
	• Black	from 01.04.2015	40707	_____	/each
	• Grey	from 01.04.2015	40711	_____	/each
	• Blue	from 01.04.2015	40715	_____	/each
	<b>Dock shelter width 3000 mm</b>				
	• Black	from 01.04.2015	40719	_____	/each
	• Grey	from 01.04.2015	40723	_____	/each
	• Blue	from 01.04.2015	40727	_____	/each
	<b>Dock shelter width 3350 mm</b>				
	• Black	from 01.05.2005	2010441	_____	/each
	• Grey	from 01.05.2005	2010442	_____	/each
	• Blue	from 01.05.2005	2010443	_____	/each
	<b>Dock shelter width 3500 mm</b>				
	• Black	from 01.05.2005	2010444	_____	/each
	• Grey	from 01.05.2005	2010445	_____	/each
• Blue	from 01.05.2005	2010446	_____	/each	
	<b>Top flap DSL (G) / DSS (G) / DSLR (G) / DSSR (G) Height 1000 mm</b>			Quantity	
	<b>Dock shelter width 2800 mm</b>				
	• Black	from 01.04.2015	40731	_____	/each
	• Grey	from 01.04.2015	40735	_____	/each
	• Blue	from 01.04.2015	40739	_____	/each
	<b>Dock shelter width 3000 mm</b>				
	• Black	from 01.04.2015	40743	_____	/each
	• Grey	from 01.04.2015	40747	_____	/each
	• Blue	from 01.04.2015	40751	_____	/each
	<b>Dock shelter width 3350 mm</b>				
	• Black	from 01.05.2005	2010447	_____	/each
	• Grey	from 01.05.2005	2010448	_____	/each
	• Blue	from 01.05.2005	2010449	_____	/each
	<b>Dock shelter width 3500 mm</b>				
	• Black	from 01.05.2005	2010450	_____	/each
	• Grey	from 01.05.2005	2010451	_____	/each
• Blue	from 01.05.2005	2010452	_____	/each	

<b>ORDER</b>	Customer no.: _____	Order no./com.: _____	<b>Please take information from the data label!</b>	
	Customer name: _____	Shipping address: _____	<b>Order no.:</b> _____	<b>Type:</b> _____
	Place/date: _____	Stamp and signature _____	<b>Dock shelter / seal no.:</b> _____	<b>Year of manufacture:</b> _____
			<b>Serial no.:</b> _____	



# Flap Shelters DS / DT

## Top flap DSL (G) / DSS (G) / DSLR (G) / DSSR (G) with Hörmann logo

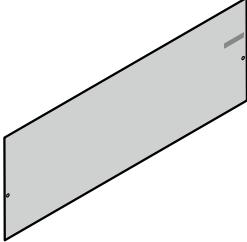
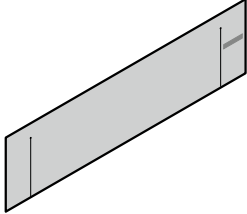
Article	Description	Production period	Art. no.	Quantity	
	<b>Top flap</b> <b>DSL (G) / DSS (G) / DSLR (G) / DSSR (G)</b> <b>Height 1200 mm</b>			Quantity	
	<b>Dock shelter width 2800 mm</b>				
	• Black	from 01.04.2015	40755	_____	/each
	• Grey	from 01.04.2015	40759	_____	/each
	• Blue	from 01.04.2015	40763	_____	/each
	<b>Dock shelter width 3000 mm</b>				
	• Black	from 01.04.2015	40767	_____	/each
	• Grey	from 01.04.2015	40771	_____	/each
	• Blue	from 01.04.2015	40775	_____	/each
	<b>Dock shelter width 3350 mm</b>				
	• Black	from 01.05.2005	2010453	_____	/each
	• Grey	from 01.05.2005	2010454	_____	/each
	• Blue	from 01.05.2005	2010455	_____	/each
	<b>Dock shelter width 3500 mm</b>				
	• Black	from 01.05.2005	2010456	_____	/each
• Grey	from 01.05.2005	2010457	_____	/each	
• Blue	from 01.05.2005	2010458	_____	/each	
	<b>Top flap</b> <b>DSL (G) / DSS (G) / DSLR (G) / DSSR (G)</b> <b>cut</b> <b>Height 900 mm</b>			Quantity	
	<b>Dock shelter width 2800 mm</b>				
	• Black	from 01.04.2015	40708	_____	/each
	• Grey	from 01.04.2015	40712	_____	/each
	• Blue	from 01.04.2015	40716	_____	/each
	<b>Dock shelter width 3000 mm</b>				
	• Black	from 01.04.2015	40720	_____	/each
	• Grey	from 01.04.2015	40724	_____	/each
	• Blue	from 01.04.2015	40728	_____	/each
	<b>Dock shelter width 3350 mm</b>				
	• Black	from 01.05.2005	2010459	_____	/each
	• Grey	from 01.05.2005	2010460	_____	/each
	• Blue	from 01.05.2005	2010461	_____	/each
	<b>Dock shelter width 3500 mm</b>				
	• Black	from 01.05.2005	2010462	_____	/each
• Grey	from 01.05.2005	2010463	_____	/each	
• Blue	from 01.05.2005	2010464	_____	/each	

<b>ORDER</b>	Customer no.: _____	Order no./com.: _____	<b>Please take information from the data label!</b>	
	Customer name: _____	Shipping address: _____	<b>Order no.:</b> _____	<b>Type:</b> _____
	Place/date: _____	Stamp and signature _____	<b>Dock shelter / seal no.:</b> _____	<b>Year of manufacture:</b> _____
			<b>Serial no.:</b> _____	

# Flap Shelters DS / DT

Top flap DSL (G) / DSS (G) / DSLR (G) / DSSR (G) with Hörmann logo

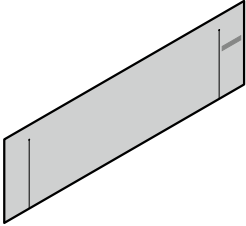
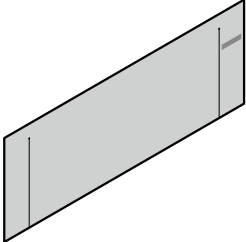
Article	Description	Production period	Art. no.	Quantity	
	<b>Top flap DSL (G) / DSS (G) / DSLR (G) / DSSR (G) cut Height 1000 mm</b>				Quantity
	<b>Dock shelter width 2800 mm</b>				
	• Black	from 01.04.2015	40732	_____	/each
	• Grey	from 01.04.2015	40736	_____	/each
	• Blue	from 01.04.2015	40740	_____	/each
	<b>Dock shelter width 3000 mm</b>				
	• Black	from 01.04.2015	40744	_____	/each
	• Grey	from 01.04.2015	40748	_____	/each
	• Blue	from 01.04.2015	40752	_____	/each
	<b>Dock shelter width 3350 mm</b>				
	• Black	from 01.05.2005	2010465	_____	/each
	• Grey	from 01.05.2005	2010466	_____	/each
	• Blue	from 01.05.2005	2010467	_____	/each
	<b>Dock shelter width 3500 mm</b>				
	• Black	from 01.05.2005	2010468	_____	/each
	• Grey	from 01.05.2005	2010469	_____	/each
	• Blue	from 01.05.2005	2010470	_____	/each
		<b>Top flap DSL (G) / DSS (G) / DSLR (G) / DSSR (G) cut Height 1200 mm</b>			
<b>Dock shelter width 2800 mm</b>					
• Black		from 01.04.2015	40756	_____	/each
• Grey		from 01.04.2015	40760	_____	/each
• Blue		from 01.04.2015	40764	_____	/each
<b>Dock shelter width 3000 mm</b>					
• Black		from 01.04.2015	40768	_____	/each
• Grey		from 01.04.2015	40772	_____	/each
• Blue		from 01.04.2015	40776	_____	/each
<b>Dock shelter width 3350 mm</b>					
• Black		from 01.05.2005	2010471	_____	/each
• Grey		from 01.05.2005	2010472	_____	/each
• Blue		from 01.05.2005	2010473	_____	/each
<b>Dock shelter width 3500 mm</b>					
• Black		from 01.05.2005	2010474	_____	/each
• Grey		from 01.05.2005	2010475	_____	/each
• Blue		from 01.05.2005	2010476	_____	/each

<b>ORDER</b>	Customer no.: _____ Order no./com.: _____	<b>Please take information from the data label!</b>
	Customer name: _____	<b>Order no.:</b> _____ <b>Type:</b> _____
	Shipping address: _____	<b>Dock shelter / seal no.:</b> _____ <b>Year of manufacture:</b> _____
	Place/date: _____	<b>Serial no.:</b> _____
		Stamp and signature

# Flap Shelters DS / DT

## Top flap DSL (G) / DSS (G) / DSLR (G) / DSSR (G) with Hörmann logo

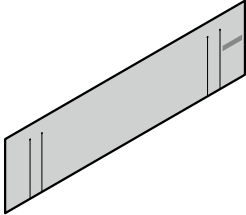
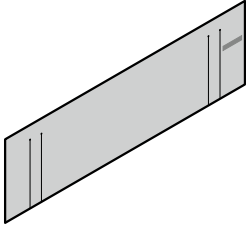
Article	Description	Production period	Art. no.	Quantity	
	<b>Top flap DSL (G) / DSS (G) / DSLR (G) / DSSR (G) double cut Height 900 mm</b>				Quantity
	<b>Dock shelter width 2800 mm</b>				
	• Black	from 01.04.2015	40709	_____	/each
	• Grey	from 01.04.2015	40713	_____	/each
	• Blue	from 01.04.2015	40717	_____	/each
	<b>Dock shelter width 3000 mm</b>				
	• Black	from 01.04.2015	40721	_____	/each
	• Grey	from 01.04.2015	40725	_____	/each
	• Blue	from 01.04.2015	40729	_____	/each
	<b>Dock shelter width 3350 mm</b>				
	• Black	from 01.05.2005	2010477	_____	/each
	• Grey	from 01.05.2005	2010478	_____	/each
	• Blue	from 01.05.2005	2010479	_____	/each
	<b>Dock shelter width 3500 mm</b>				
	• Black	from 01.05.2005	2010480	_____	/each
	• Grey	from 01.05.2005	2010481	_____	/each
• Blue	from 01.05.2005	2010482	_____	/each	
	<b>Top flap DSL (G) / DSS (G) / DSLR (G) / DSSR (G) double cut Height 1000 mm</b>				Quantity
	<b>Dock shelter width 2800 mm</b>				
	• Black	from 01.04.2015	40733	_____	/each
	• Grey	from 01.04.2015	40737	_____	/each
	• Blue	from 01.04.2015	40741	_____	/each
	<b>Dock shelter width 3000 mm</b>				
	• Black	from 01.04.2015	40745	_____	/each
	• Grey	from 01.04.2015	40749	_____	/each
	• Blue	from 01.04.2015	40753	_____	/each
	<b>Dock shelter width 3350 mm</b>				
	• Black	from 01.05.2005	2010483	_____	/each
	• Grey	from 01.05.2005	2010484	_____	/each
	• Blue	from 01.05.2005	2010485	_____	/each
	<b>Dock shelter width 3500 mm</b>				
	• Black	from 01.05.2005	2010486	_____	/each
	• Grey	from 01.05.2005	2010487	_____	/each
• Blue	from 01.05.2005	2010488	_____	/each	

<b>ORDER</b>	Customer no.: _____	Order no./com.: _____	<b>Please take information from the data label!</b>	
	Customer name: _____	Shipping address: _____	<b>Order no.:</b> _____	<b>Type:</b> _____
	Place/date: _____	Stamp and signature _____	<b>Dock shelter / seal no.:</b> _____	<b>Year of manufacture:</b> _____
			<b>Serial no.:</b> _____	

# Flap Shelters DS / DT

Top flap DSL (G) / DSS (G) / DSLR (G) / DSSR (G) with Hörmann logo

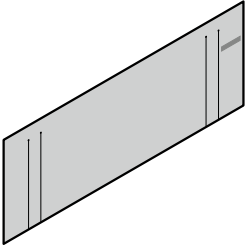
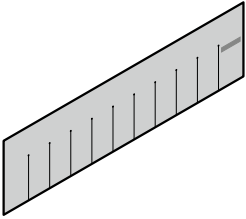
Article	Description	Production period	Art. no.	Quantity	
	<b>Top flap</b> <b>DSL (G) / DSS (G) / DSLR (G) / DSSR (G)</b> <b>double cut</b> <b>Height 1200 mm</b> <b>Dock shelter width 2800 mm</b>			Quantity	
	<ul style="list-style-type: none"> <li>• Black</li> </ul>	from 01.04.2015	40757	_____	/each
	<ul style="list-style-type: none"> <li>• Grey</li> </ul>	from 01.04.2015	40761	_____	/each
	<ul style="list-style-type: none"> <li>• Blue</li> </ul>	from 01.04.2015	40765	_____	/each
	<b>Dock shelter width 3000 mm</b>				
	<ul style="list-style-type: none"> <li>• Black</li> </ul>	from 01.04.2015	40769	_____	/each
	<ul style="list-style-type: none"> <li>• Grey</li> </ul>	from 01.04.2015	40773	_____	/each
	<ul style="list-style-type: none"> <li>• Blue</li> </ul>	from 01.04.2015	40777	_____	/each
	<b>Dock shelter width 3350 mm</b>				
	<ul style="list-style-type: none"> <li>• Black</li> </ul>	from 01.05.2005	2010489	_____	/each
	<ul style="list-style-type: none"> <li>• Grey</li> </ul>	from 01.05.2005	2010490	_____	/each
	<ul style="list-style-type: none"> <li>• Blue</li> </ul>	from 01.05.2005	2010491	_____	/each
	<b>Dock shelter width 3500 mm</b>				
	<ul style="list-style-type: none"> <li>• Black</li> </ul>	from 01.05.2005	2010492	_____	/each
	<ul style="list-style-type: none"> <li>• Grey</li> </ul>	from 01.05.2005	2010493	_____	/each
	<ul style="list-style-type: none"> <li>• Blue</li> </ul>	from 01.05.2005	2010494	_____	/each
	<b>Top flap</b> <b>DSL (G) / DSS (G) / DSLR (G) / DSSR (G)</b> <b>Fully laminated</b> <b>Height 900 mm</b> <b>Dock shelter width 2800 mm</b>			Quantity	
	<ul style="list-style-type: none"> <li>• Black</li> </ul>	from 01.04.2015	40710	_____	/each
	<ul style="list-style-type: none"> <li>• Grey</li> </ul>	from 01.04.2015	40714	_____	/each
	<ul style="list-style-type: none"> <li>• Blue</li> </ul>	from 01.04.2015	40718	_____	/each
	<b>Dock shelter width 3000 mm</b>				
	<ul style="list-style-type: none"> <li>• Black</li> </ul>	from 01.04.2015	40722	_____	/each
	<ul style="list-style-type: none"> <li>• Grey</li> </ul>	from 01.04.2015	40726	_____	/each
	<ul style="list-style-type: none"> <li>• Blue</li> </ul>	from 01.04.2015	40730	_____	/each
	<b>Dock shelter width 3350 mm</b>				
	<ul style="list-style-type: none"> <li>• Black</li> </ul>	from 01.05.2005	2010495	_____	/each
	<ul style="list-style-type: none"> <li>• Grey</li> </ul>	from 01.05.2005	2010496	_____	/each
	<ul style="list-style-type: none"> <li>• Blue</li> </ul>	from 01.05.2005	2010497	_____	/each
	<b>Dock shelter width 3500 mm</b>				
	<ul style="list-style-type: none"> <li>• Black</li> </ul>	from 01.05.2005	2010498	_____	/each
	<ul style="list-style-type: none"> <li>• Grey</li> </ul>	from 01.05.2005	2010499	_____	/each
	<ul style="list-style-type: none"> <li>• Blue</li> </ul>	from 01.05.2005	2010500	_____	/each

<b>ORDER</b>	Customer no.: _____	Order no./com.: _____	<b>Please take information from the data label!</b>	
			<b>Order no.:</b> _____	<b>Type:</b> _____
	Customer name: _____		<b>Dock shelter / seal no.:</b> _____	<b>Year of manufacture:</b> _____
	Shipping address: _____		<b>Serial no.:</b> _____	
Place/date: _____		Stamp and signature _____		

# Flap Shelters DS / DT

## Top flap DSL (G) / DSS (G) / DSLR (G) / DSSR (G) with Hörmann logo

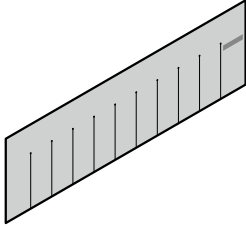
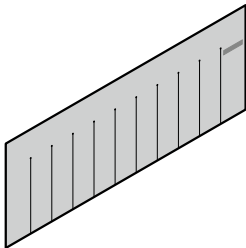
Article	Description	Production period	Art. no.	Quantity	
	<b>Top flap DSL (G) / DSS (G) / DSLR (G) / DSSR (G) Fully laminated Height 1000 mm</b>			Quantity	
	<b>Dock shelter width 2800 mm</b>				
	• Black	from 01.04.2015	40734	_____	/each
	• Grey	from 01.04.2015	40738	_____	/each
	• Blue	from 01.04.2015	40742	_____	/each
	<b>Dock shelter width 3000 mm</b>				
	• Black	from 01.04.2015	40746	_____	/each
	• Grey	from 01.04.2015	40750	_____	/each
	• Blue	from 01.04.2015	40754	_____	/each
	<b>Dock shelter width 3350 mm</b>				
	• Black	from 01.05.2005	2010501	_____	/each
	• Grey	from 01.05.2005	2010502	_____	/each
	• Blue	from 01.05.2005	2010503	_____	/each
	<b>Dock shelter width 3500 mm</b>				
	• Black	from 01.05.2005	2010504	_____	/each
	• Grey	from 01.05.2005	2010505	_____	/each
• Blue	from 01.05.2005	2010506	_____	/each	
	<b>Top flap DSL (G) / DSS (G) / DSLR (G) / DSSR (G) Fully laminated Height 1200 mm</b>			Quantity	
	<b>Dock shelter width 2800 mm</b>				
	• Black	from 01.04.2015	40758	_____	/each
	• Grey	from 01.04.2015	40762	_____	/each
	• Blue	from 01.04.2015	40766	_____	/each
	<b>Dock shelter width 3000 mm</b>				
	• Black	from 01.04.2015	40770	_____	/each
	• Grey	from 01.04.2015	40774	_____	/each
	• Blue	from 01.04.2015	40778	_____	/each
	<b>Dock shelter width 3350 mm</b>				
	• Black	from 01.05.2005	2010507	_____	/each
	• Grey	from 01.05.2005	2010508	_____	/each
	• Blue	from 01.05.2005	2010509	_____	/each
	<b>Dock shelter width 3500 mm</b>				
	• Black	from 01.05.2005	2010510	_____	/each
	• Grey	from 01.05.2005	2010511	_____	/each
• Blue	from 01.05.2005	2010512	_____	/each	

<b>ORDER</b>	Customer no.: _____	Order no./com.: _____	<b>Please take information from the data label!</b>	
	Customer name: _____	Shipping address: _____	<b>Order no.:</b> _____	<b>Type:</b> _____
	Place/date: _____	Stamp and signature _____	<b>Dock shelter / seal no.:</b> _____	<b>Year of manufacture:</b> _____
			<b>Serial no.:</b> _____	

# Flap Shelters DS / DT

## Top flap DTL (G) / DTS (G) / DTLR (G) / DTSR (G) with Hörmann logo

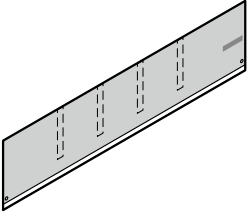
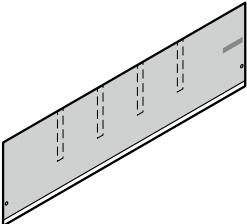
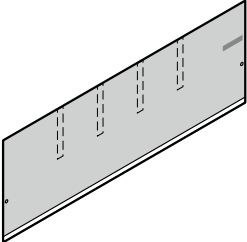
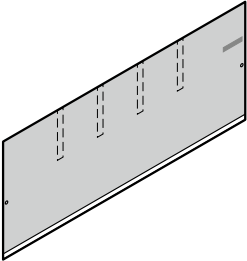
Article	Description	Production period	Art. no.	Quantity	
	<b>Top flap</b> <b>DTL (G) / DTS (G) / DTLR (G) / DTSR (G)</b> <b>Height 900 mm</b> <b>Dock shelter width 3350 mm</b>	from 01.05.2005	2010513	Quantity	_____ /each
	<ul style="list-style-type: none"> <li>• Black</li> <li>• Grey</li> <li>• Blue</li> </ul>	from 01.05.2005	2010514	_____	_____ /each
	<b>Dock shelter width 3500 mm</b>	from 01.05.2005	2010515	_____	_____ /each
	<ul style="list-style-type: none"> <li>• Black</li> <li>• Grey</li> <li>• Blue</li> </ul>	from 01.05.2005	2010516	_____	_____ /each
	<ul style="list-style-type: none"> <li>• Black</li> <li>• Grey</li> <li>• Blue</li> </ul>	from 01.05.2005	2010517	_____	_____ /each
	<ul style="list-style-type: none"> <li>• Black</li> <li>• Grey</li> <li>• Blue</li> </ul>	from 01.05.2005	2010518	_____	_____ /each
	<b>Top flap</b> <b>DTL (G) / DTS (G) / DTLR (G) / DTSR (G)</b> <b>Height 1000 mm</b> <b>Dock shelter width 3350 mm</b>	from 01.05.2005	2010519	Quantity	_____ /each
	<ul style="list-style-type: none"> <li>• Black</li> <li>• Grey</li> <li>• Blue</li> </ul>	from 01.05.2005	2010520	_____	_____ /each
	<b>Dock shelter width 3500 mm</b>	from 01.05.2005	2010521	_____	_____ /each
	<ul style="list-style-type: none"> <li>• Black</li> <li>• Grey</li> <li>• Blue</li> </ul>	from 01.05.2005	2010522	_____	_____ /each
	<ul style="list-style-type: none"> <li>• Black</li> <li>• Grey</li> <li>• Blue</li> </ul>	from 01.05.2005	2010523	_____	_____ /each
	<ul style="list-style-type: none"> <li>• Black</li> <li>• Grey</li> <li>• Blue</li> </ul>	from 01.05.2005	2010524	_____	_____ /each
	<b>Top flap</b> <b>DTL (G) / DTS (G) / DTLR (G) / DTSR (G)</b> <b>Height 1200 mm</b> <b>Dock shelter width 3350 mm</b>	from 01.05.2005	2010525	Quantity	_____ /each
	<ul style="list-style-type: none"> <li>• Black</li> <li>• Grey</li> <li>• Blue</li> </ul>	from 01.05.2005	2010526	_____	_____ /each
	<b>Dock shelter width 3500 mm</b>	from 01.05.2005	2010527	_____	_____ /each
	<ul style="list-style-type: none"> <li>• Black</li> <li>• Grey</li> <li>• Blue</li> </ul>	from 01.05.2005	2010528	_____	_____ /each
	<ul style="list-style-type: none"> <li>• Black</li> <li>• Grey</li> <li>• Blue</li> </ul>	from 01.05.2005	2010529	_____	_____ /each
	<ul style="list-style-type: none"> <li>• Black</li> <li>• Grey</li> <li>• Blue</li> </ul>	from 01.05.2005	2010530	_____	_____ /each
	<b>Top flap</b> <b>DTL (G) / DTS (G) / DTLR (G) / DTSR (G)</b> <b>Height 1350 mm</b> <b>Dock shelter width 3350 mm</b>	from 01.05.2005	2010531	Quantity	_____ /each
	<ul style="list-style-type: none"> <li>• Black</li> <li>• Grey</li> <li>• Blue</li> </ul>	from 01.05.2005	2010532	_____	_____ /each
	<b>Dock shelter width 3500 mm</b>	from 01.05.2005	2010533	_____	_____ /each
	<ul style="list-style-type: none"> <li>• Black</li> <li>• Grey</li> <li>• Blue</li> </ul>	from 01.05.2005	2010534	_____	_____ /each
	<ul style="list-style-type: none"> <li>• Black</li> <li>• Grey</li> <li>• Blue</li> </ul>	from 01.05.2005	2010535	_____	_____ /each
	<ul style="list-style-type: none"> <li>• Black</li> <li>• Grey</li> <li>• Blue</li> </ul>	from 01.05.2005	2010536	_____	_____ /each

<b>ORDER</b>	Customer no.:	Order no./com.:	<b>Please take information from the data label!</b>	
	Customer name:	Shipping address:		Order no.:
	Shipping address:	Place/date:		Type:
	Place/date:	Stamp and signature		Dock shelter / seal no.:
	Place/date:	Stamp and signature		Year of manufacture:
Place/date:	Stamp and signature		Serial no.:	

# Flap Shelters DS / DT

## Top flap DSN(G) with Hörmann logo

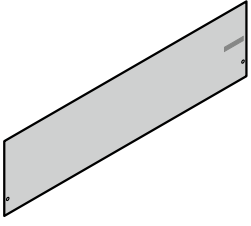
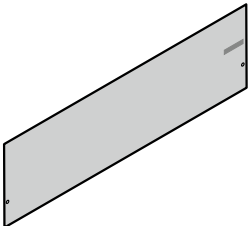
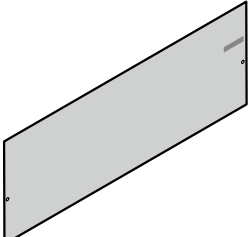
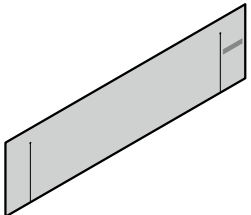
Article	Description	Production period	Art. no.	Quantity	
	<b>Top flap DSN(G)</b> <b>Height 900 mm</b>			Quantity	
	<b>Dock shelter width 3350 mm</b>			_____	<b>/each</b>
	• Black	from 01.05.2005	2010537	_____	<b>/each</b>
	• Grey	from 01.05.2005	2010538	_____	<b>/each</b>
	• Blue	from 01.05.2005	2010539	_____	<b>/each</b>
	<b>Dock shelter width 3500 mm</b>			_____	<b>/each</b>
	<b>Top flap DSN(G)</b> <b>Height 1000 mm</b>			Quantity	
	<b>Dock shelter width 3350 mm</b>			_____	<b>/each</b>
	• Black	from 01.05.2005	2010543	_____	<b>/each</b>
	• Grey	from 01.05.2005	2010544	_____	<b>/each</b>
	• Blue	from 01.05.2005	2010545	_____	<b>/each</b>
	<b>Dock shelter width 3500 mm</b>			_____	<b>/each</b>
	<b>Top flap DSN(G)</b> <b>Height 1200 mm</b>			Quantity	
	<b>Dock shelter width 3350 mm</b>			_____	<b>/each</b>
	• Black	from 01.05.2005	2010549	_____	<b>/each</b>
	• Grey	from 01.05.2005	2010550	_____	<b>/each</b>
	• Blue	from 01.05.2005	2010551	_____	<b>/each</b>
	<b>Dock shelter width 3500 mm</b>			_____	<b>/each</b>
	<b>Top flap DSN(G)</b> <b>cut</b> <b>Height 900 mm</b>			Quantity	
	<b>Dock shelter width 3350 mm</b>			_____	<b>/each</b>
	• Black	from 01.05.2005	2010555	_____	<b>/each</b>
	• Grey	from 01.05.2005	2010556	_____	<b>/each</b>
	• Blue	from 01.05.2005	2010557	_____	<b>/each</b>
	<b>Dock shelter width 3500 mm</b>			_____	<b>/each</b>
	• Black	from 01.05.2005	2010558	_____	<b>/each</b>
	• Grey	from 01.05.2005	2010559	_____	<b>/each</b>
	• Blue	from 01.05.2005	2010560	_____	<b>/each</b>

<b>ORDER</b>	Customer no.: _____	Order no./com.: _____	<b>Please take information from the data label!</b>	
			<b>Order no.:</b> _____	<b>Type:</b> _____
	Customer name: _____		<b>Dock shelter / seal no.:</b> _____	<b>Year of manufacture:</b> _____
	Shipping address: _____		<b>Serial no.:</b> _____	
	Place/date: _____		Stamp and signature _____	

# Flap Shelters DS / DT

## Top flap DSN(G) with Hörmann logo

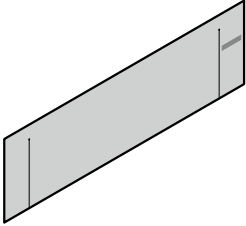
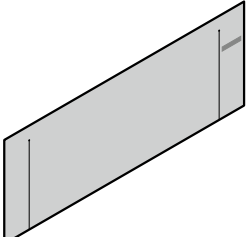
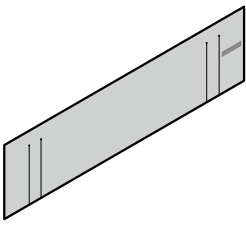
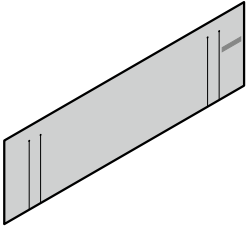
Article	Description	Production period	Art. no.	Quantity	
	<b>Top flap DSN(G) cut</b> <b>Height 1000 mm</b> <b>Dock shelter width 3350 mm</b>			Quantity	
	• Black	from 01.05.2005	2010561	_____	<b>/each</b>
	• Grey	from 01.05.2005	2010562	_____	<b>/each</b>
	• Blue	from 01.05.2005	2010563	_____	<b>/each</b>
	<b>Dock shelter width 3500 mm</b>				
	• Black	from 01.05.2005	2010564	_____	<b>/each</b>
• Grey	from 01.05.2005	2010565	_____	<b>/each</b>	
• Blue	from 01.05.2005	2010566	_____	<b>/each</b>	
	<b>Top flap DSN(G) cut</b> <b>Height 1200 mm</b> <b>Dock shelter width 3350 mm</b>			Quantity	
	• Black	from 01.05.2005	2010567	_____	<b>/each</b>
	• Grey	from 01.05.2005	2010568	_____	<b>/each</b>
	• Blue	from 01.05.2005	2010569	_____	<b>/each</b>
	<b>Dock shelter width 3500 mm</b>				
	• Black	from 01.05.2005	2010570	_____	<b>/each</b>
• Grey	from 01.05.2005	2010571	_____	<b>/each</b>	
• Blue	from 01.05.2005	2010572	_____	<b>/each</b>	
	<b>Top flap DSN(G) double cut</b> <b>Height 900 mm</b> <b>Dock shelter width 3350 mm</b>			Quantity	
	• Black	from 01.05.2005	2010573	_____	<b>/each</b>
	• Grey	from 01.05.2005	2010574	_____	<b>/each</b>
	• Blue	from 01.05.2005	2010575	_____	<b>/each</b>
	<b>Dock shelter width 3500 mm</b>				
	• Black	from 01.05.2005	2010576	_____	<b>/each</b>
• Grey	from 01.05.2005	2010577	_____	<b>/each</b>	
• Blue	from 01.05.2005	2010578	_____	<b>/each</b>	
	<b>Top flap DSN(G) double cut</b> <b>Height 1000 mm</b> <b>Dock shelter width 3350 mm</b>			Quantity	
	• Black	from 01.05.2005	2010579	_____	<b>/each</b>
	• Grey	from 01.05.2005	2010580	_____	<b>/each</b>
	• Blue	from 01.05.2005	2010581	_____	<b>/each</b>
	<b>Dock shelter width 3500 mm</b>				
	• Black	from 01.05.2005	2010582	_____	<b>/each</b>
• Grey	from 01.05.2005	2010583	_____	<b>/each</b>	
• Blue	from 01.05.2005	2010584	_____	<b>/each</b>	

<b>ORDER</b>	Customer no.: _____	Order no./com.: _____	<b>Please take information from the data label!</b>	
	Customer name: _____	Shipping address: _____	<b>Order no.:</b> _____	<b>Type:</b> _____
	Place/date: _____	Stamp and signature _____	<b>Dock shelter / seal no.:</b> _____	<b>Year of manufacture:</b> _____
			<b>Serial no.:</b> _____	



# Flap Shelters DS / DT

## Top flap DSN(G) with Hörmann logo

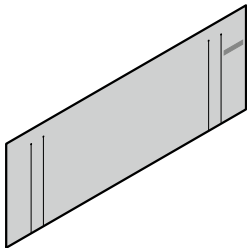
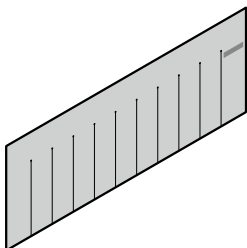
Article	Description	Production period	Art. no.	Quantity	
	<b>Top flap DSN(G)</b> <b>double cut</b> <b>Height 1200 mm</b> <b>Dock shelter width 3350 mm</b> <ul style="list-style-type: none"> <li>• Black</li> <li>• Grey</li> <li>• Blue</li> </ul>	from 01.05.2005 from 01.05.2005 from 01.05.2005	2010585 2010586 2010587	_____ _____ _____	/each /each /each
	<b>Dock shelter width 3500 mm</b> <ul style="list-style-type: none"> <li>• Black</li> <li>• Grey</li> <li>• Blue</li> </ul>	from 01.05.2005 from 01.05.2005 from 01.05.2005	2010588 2010589 2010590	_____ _____ _____	/each /each /each
	<b>Top flap DSN(G)</b> <b>Fully laminated</b> <b>Height 900 mm</b> <b>Dock shelter width 3350 mm</b> <ul style="list-style-type: none"> <li>• Black</li> <li>• Grey</li> <li>• Blue</li> </ul>	from 01.05.2005 from 01.05.2005 from 01.05.2005	2010591 2010592 2010593	_____ _____ _____	/each /each /each
	<b>Dock shelter width 3500 mm</b> <ul style="list-style-type: none"> <li>• Black</li> <li>• Grey</li> <li>• Blue</li> </ul>	from 01.05.2005 from 01.05.2005 from 01.05.2005	2010594 2010595 2010596	_____ _____ _____	/each /each /each
	<b>Top flap DSN(G)</b> <b>Fully laminated</b> <b>Height 1000 mm</b> <b>Dock shelter width 3350 mm</b> <ul style="list-style-type: none"> <li>• Black</li> <li>• Grey</li> <li>• Blue</li> </ul>	from 01.05.2005 from 01.05.2005 from 01.05.2005	2010597 2010598 2010599	_____ _____ _____	/each /each /each
	<b>Dock shelter width 3500 mm</b> <ul style="list-style-type: none"> <li>• Black</li> <li>• Grey</li> <li>• Blue</li> </ul>	from 01.05.2005 from 01.05.2005 from 01.05.2005	2010600 2010601 2010602	_____ _____ _____	/each /each /each
	<b>Top flap DSN(G)</b> <b>Fully laminated</b> <b>Height 1200 mm</b> <b>Dock shelter width 3350 mm</b> <ul style="list-style-type: none"> <li>• Black</li> <li>• Grey</li> <li>• Blue</li> </ul>	from 01.05.2005 from 01.05.2005 from 01.05.2005	2010603 2010604 2010605	_____ _____ _____	/each /each /each
	<b>Dock shelter width 3500 mm</b> <ul style="list-style-type: none"> <li>• Black</li> <li>• Grey</li> <li>• Blue</li> </ul>	from 01.05.2005 from 01.05.2005 from 01.05.2005	2010606 2010607 2010608	_____ _____ _____	/each /each /each

<b>ORDER</b>	Customer no.: _____	Order no./com.: _____	<b>Please take information from the data label!</b>	
			<b>Order no.:</b> _____	<b>Type:</b> _____
	Customer name: _____		<b>Dock shelter / seal no.:</b> _____	<b>Year of manufacture:</b> _____
	Shipping address: _____		<b>Serial no.:</b> _____	
	Place/date: _____		Stamp and signature _____	

# Flap Shelters DS / DT

## Side cladding

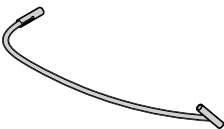
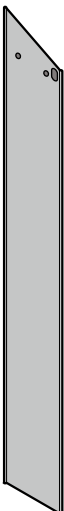
Article	Description	Production period	Art. no.	Quantity	
	<b>Easy fix</b>	from 01.05.2005	309189	Quantity _____	<b>/each</b>
 Image: on right	<b>Side cladding*</b> <b>DSL (G) / DSS (G) / DTL (G) / DTS (G)</b> <b>Depth 500 mm</b> <b>Right</b>			Quantity	
	<b>Dock shelter height 2800 mm</b>				
	• Black	from 01.04.2015	40911	_____	<b>/each</b>
	• Grey	from 01.04.2015	40921	_____	<b>/each</b>
	• Blue	from 01.04.2015	40916	_____	<b>/each</b>
	<b>Dock shelter height 3000 mm</b>				
	• Black	from 01.04.2015	40912	_____	<b>/each</b>
	• Grey	from 01.04.2015	40922	_____	<b>/each</b>
	• Blue	from 01.04.2015	40917	_____	<b>/each</b>
	<b>Dock shelter height 3500 mm</b>				
	• Black	01.05.2005–31.03.2015	2010609	_____	<b>/each</b>
	• Grey	01.05.2005–31.03.2015	2010610	_____	<b>/each</b>
	• Blue	01.05.2005–31.03.2015	2010611	_____	<b>/each</b>
	• Black	from 01.04.2015	40913	_____	<b>/each</b>
	• Grey	from 01.04.2015	40923	_____	<b>/each</b>
	• Blue	from 01.04.2015	40918	_____	<b>/each</b>
	<b>Dock shelter height 3750 mm</b>				
	• Black	01.05.2005–31.03.2015	2010612	_____	<b>/each</b>
	• Grey	01.05.2005–31.03.2015	2010613	_____	<b>/each</b>
	• Blue	01.05.2005–31.03.2015	2010614	_____	<b>/each</b>
• Black	from 01.04.2015	40914	_____	<b>/each</b>	
• Grey	from 01.04.2015	40924	_____	<b>/each</b>	
• Blue	from 01.04.2015	40919	_____	<b>/each</b>	
<b>Dock shelter height 4500 mm</b>					
• Black	01.05.2005–31.03.2015	2010615	_____	<b>/each</b>	
• Grey	01.05.2005–31.03.2015	2010616	_____	<b>/each</b>	
• Blue	01.05.2005–31.03.2015	2010617	_____	<b>/each</b>	
• Black	from 01.04.2015	40915	_____	<b>/each</b>	
• Grey	from 01.04.2015	40925	_____	<b>/each</b>	
• Blue	from 01.05.2005	40920	_____	<b>/each</b>	

\* incl. Easy fix

<b>ORDER</b>	Customer no.: _____	Order no./com.: _____	<b>Please take information from the data label!</b>	
	Customer name: _____	Shipping address: _____	<b>Order no.:</b> _____	<b>Type:</b> _____
	Place/date: _____	Stamp and signature _____	<b>Dock shelter / seal no.:</b> _____	<b>Year of manufacture:</b> _____
			<b>Serial no.:</b> _____	

# Flap Shelters DS / DT

## Side cladding

Article	Description	Production period	Art. no.	Quantity	
	<b>Side cladding*</b> <b>DSL (G) / DSS (G) / DTL (G) / DTS (G)</b> <b>Depth 500 mm</b> <b>Left</b>			Quantity	
	<b>Dock shelter height 2800 mm</b>				
	• Black	from 01.04.2015	40881	_____	/each
	• Grey	from 01.04.2015	40891	_____	/each
	• Blue	from 01.04.2015	40886	_____	/each
	<b>Dock shelter height 3000 mm</b>				
	• Black	from 01.04.2015	40882	_____	/each
	• Grey	from 01.04.2015	40892	_____	/each
	• Blue	from 01.04.2015	40887	_____	/each
	<b>Dock shelter height 3500 mm</b>				
	• Black	01.05.2005–31.03.2015	2010618	_____	/each
	• Grey	01.05.2005–31.03.2015	2010619	_____	/each
	• Blue	01.05.2005–31.03.2015	2010620	_____	/each
	• Black	from 01.04.2015	40883	_____	/each
	• Grey	from 01.04.2015	40893	_____	/each
	• Blue	from 01.04.2015	40888	_____	/each
	<b>Dock shelter height 3750 mm</b>				
	• Black	01.05.2005–31.03.2015	2010621	_____	/each
	• Grey	01.05.2005–31.03.2015	2010622	_____	/each
	• Blue	01.05.2005–31.03.2015	2010623	_____	/each
	• Black	from 01.04.2015	40884	_____	/each
	• Grey	from 01.04.2015	40894	_____	/each
	• Blue	from 01.04.2015	40889	_____	/each
	<b>Dock shelter height 4500 mm</b>				
	• Black	01.05.2005–31.03.2015	2010624	_____	/each
	• Grey	01.05.2005–31.03.2015	2010625	_____	/each
	• Blue	01.05.2005–31.03.2015	2010626	_____	/each
	• Black	from 01.04.2015	40885	_____	/each
	• Grey	from 01.04.2015	40895	_____	/each
	• Blue	from 01.05.2005	40890	_____	/each

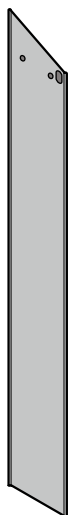



Image: on right

\* incl. Easy fix

<b>ORDER</b>	Customer no.: _____ Order no./com.: _____	<b>Please take information from the data label!</b>	
	Customer name: _____	<b>Order no.:</b> _____	<b>Type:</b> _____
	Shipping address: _____	<b>Dock shelter / seal no.:</b> _____	<b>Year of manufacture:</b> _____
	Place/date: _____	<b>Serial no.:</b> _____	
		Stamp and signature _____	

# Flap Shelters DS / DT

## Side cladding

Article	Description	Production period	Art. no.	Quantity	
	<b>Side cladding*</b> <b>DSL (G) / DSS (G) /</b> <b>DTL (G) / DTS (G)</b> <b>Depth 500 mm</b> <b>right = left</b>			Quantity	
	<b>Dock shelter height 2800 mm</b> <ul style="list-style-type: none"> <li>• Black</li> </ul>	from 01.04.2015	40803	_____	<b>/each</b>
	<ul style="list-style-type: none"> <li>• Grey</li> </ul>	from 01.04.2015	40813	_____	<b>/each</b>
	<ul style="list-style-type: none"> <li>• Blue</li> </ul>	from 01.04.2015	40808	_____	<b>/each</b>
	<b>Dock shelter height 3000 mm</b> <ul style="list-style-type: none"> <li>• Black</li> </ul>	from 01.04.2015	40804	_____	<b>/each</b>
	<ul style="list-style-type: none"> <li>• Grey</li> </ul>	from 01.04.2015	40814	_____	<b>/each</b>
	<ul style="list-style-type: none"> <li>• Blue</li> </ul>	from 01.04.2015	40809	_____	<b>/each</b>
	<b>Dock shelter height 3500 mm</b> <ul style="list-style-type: none"> <li>• Black</li> </ul>	from 01.04.2015	40805	_____	<b>/each</b>
	<ul style="list-style-type: none"> <li>• Grey</li> </ul>	from 01.04.2015	40815	_____	<b>/each</b>
	<ul style="list-style-type: none"> <li>• Blue</li> </ul>	from 01.04.2015	40810	_____	<b>/each</b>
	<b>Dock shelter height 3750 mm</b> <ul style="list-style-type: none"> <li>• Black</li> </ul>	from 01.04.2015	40806	_____	<b>/each</b>
	<ul style="list-style-type: none"> <li>• Grey</li> </ul>	from 01.04.2015	40816	_____	<b>/each</b>
	<ul style="list-style-type: none"> <li>• Blue</li> </ul>	from 01.04.2015	40811	_____	<b>/each</b>
	<b>Dock shelter height 4500 mm</b> <ul style="list-style-type: none"> <li>• Black</li> </ul>	from 01.04.2015	40807	_____	<b>/each</b>
	<ul style="list-style-type: none"> <li>• Grey</li> </ul>	from 01.04.2015	40817	_____	<b>/each</b>
	<ul style="list-style-type: none"> <li>• Blue</li> </ul>	from 01.05.2005	40812	_____	<b>/each</b>

\* incl. Easy fix

<b>ORDER</b>	Customer no.: _____	Order no./com.: _____	<b>Please take information from the data label!</b>	
	Customer name: _____	Shipping address: _____	<b>Order no.:</b> _____	<b>Type:</b> _____
	Place/date: _____	Stamp and signature _____	<b>Dock shelter / seal no.:</b> _____	<b>Year of manufacture:</b> _____
			<b>Serial no.:</b> _____	

# Flap Shelters DS / DT

## Side cladding

Article	Description	Production period	Art. no.	Quantity	
	<b>Side cladding*</b> <b>DSL (G) / DSS (G) / DTL (G) / DTS (G)</b> <b>Depth 600 mm</b> <b>Right</b>			Quantity	
	<b>Dock shelter height 2800 mm</b>				
	• Black	from 01.04.2015	40926	_____	/each
	• Grey	from 01.04.2015	40936	_____	/each
	• Blue	from 01.04.2015	40931	_____	/each
	<b>Dock shelter height 3000 mm</b>				
	• Black	from 01.04.2015	40927	_____	/each
	• Grey	from 01.04.2015	40937	_____	/each
	• Blue	from 01.04.2015	40932	_____	/each
	<b>Dock shelter height 3500 mm</b>				
	• Black	01.05.2005 – 31.03.2015	2010627	_____	/each
	• Grey	01.05.2005 – 31.03.2015	2010628	_____	/each
	• Blue	01.05.2005 – 31.03.2015	2010629	_____	/each
	• Black	from 01.04.2015	40928	_____	/each
	• Grey	from 01.04.2015	40938	_____	/each
	• Blue	from 01.04.2015	40933	_____	/each
	<b>Dock shelter height 3750 mm</b>				
	• Black	01.05.2005 – 31.03.2015	2010630	_____	/each
	• Grey	01.05.2005 – 31.03.2015	2010631	_____	/each
	• Blue	01.05.2005 – 31.03.2015	2010632	_____	/each
	• Black	from 01.04.2015	40929	_____	/each
	• Grey	from 01.04.2015	40939	_____	/each
	• Blue	from 01.04.2015	40934	_____	/each
	<b>Dock shelter height 4500 mm</b>				
	• Black	01.05.2005 – 31.03.2015	2010633	_____	/each
	• Grey	01.05.2005 – 31.03.2015	2010634	_____	/each
	• Blue	01.05.2005 – 31.03.2015	2010635	_____	/each
	• Black	from 01.04.2015	40930	_____	/each
	• Grey	from 01.04.2015	40940	_____	/each
	• Blue	from 01.05.2005	40935	_____	/each

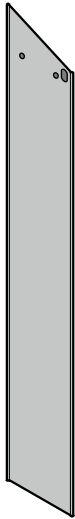

Image: on right

\* incl. Easy fix

<b>ORDER</b>	Customer no.: _____	Order no./com.: _____	<b>Please take information from the data label!</b>	
			<b>Order no.:</b> _____	<b>Type:</b> _____
	Customer name: _____		<b>Dock shelter / seal no.:</b> _____	<b>Year of manufacture:</b> _____
	Shipping address: _____		<b>Serial no.:</b> _____	
	Place/date: _____		Stamp and signature _____	

# Flap Shelters DS / DT

## Side cladding

Article	Description	Production period	Art. no.	Quantity	
	<b>Side cladding*</b> <b>DSL (G) / DSS (G) / DTL (G) / DTS (G)</b> <b>Depth 600 mm</b>			Quantity	
	<b>Left</b>				
	<b>Dock shelter height 2800 mm</b>				
	• Black	from 01.04.2015	40896	_____	/each
	• Grey	from 01.04.2015	40906	_____	/each
	• Blue	from 01.04.2015	40901	_____	/each
	<b>Dock shelter height 3000 mm</b>				
	• Black	from 01.04.2015	40897	_____	/each
	• Grey	from 01.04.2015	40907	_____	/each
	• Blue	from 01.04.2015	40902	_____	/each
	<b>Dock shelter height 3500 mm</b>				
	• Black	01.05.2005 – 31.03.2015	2010636	_____	/each
	• Grey	01.05.2005 – 31.03.2015	2010637	_____	/each
	• Blue	01.05.2005 – 31.03.2015	2010638	_____	/each
	• Black	from 01.04.2015	40898	_____	/each
	• Grey	from 01.04.2015	40908	_____	/each
	• Blue	from 01.04.2015	40903	_____	/each
	<b>Dock shelter height 3750 mm</b>				
	• Black	01.05.2005 – 31.03.2015	2010639	_____	/each
	• Grey	01.05.2005 – 31.03.2015	2010640	_____	/each
	• Blue	01.05.2005 – 31.03.2015	2010641	_____	/each
	• Black	from 01.04.2015	40899	_____	/each
	• Grey	from 01.04.2015	40909	_____	/each
	• Blue	from 01.04.2015	40904	_____	/each
	<b>Dock shelter height 4500 mm</b>				
	• Black	01.05.2005 – 31.03.2015	2010642	_____	/each
	• Grey	01.05.2005 – 31.03.2015	2010643	_____	/each
	• Blue	01.05.2005 – 31.03.2015	2010644	_____	/each
	• Black	from 01.04.2015	40900	_____	/each
	• Grey	from 01.04.2015	40910	_____	/each
	• Blue	from 01.05.2005	40905	_____	/each



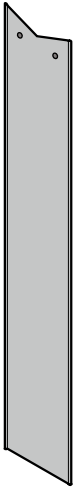

Image: on right

\* incl. Easy fix

<b>ORDER</b>	Customer no.: _____	Order no./com.: _____	<b>Please take information from the data label!</b>	
	Customer name: _____	Shipping address: _____	<b>Order no.:</b> _____	<b>Type:</b> _____
	Place/date: _____		<b>Dock shelter / seal no.:</b> _____	<b>Year of manufacture:</b> _____
			<b>Serial no.:</b> _____	
			Stamp and signature	

# Flap Shelters DS / DT

## Side cladding



Article	Description	Production period	Art. no.	Quantity	
	<b>Side cladding*</b> <b>DSL (G) / DSS (G) /</b> <b>DTLR (G) / DTSR (G)</b> <b>Depth 600 mm</b> <b>right = left</b> <b>Dock shelter height 2800 mm</b>			Quantity	
	<ul style="list-style-type: none"> <li>• Black</li> </ul>	from 01.04.2015	40818	_____	/each
	<ul style="list-style-type: none"> <li>• Grey</li> </ul>	from 01.04.2015	40828	_____	/each
	<ul style="list-style-type: none"> <li>• Blue</li> </ul>	from 01.04.2015	40823	_____	/each
	<b>Dock shelter height 3000 mm</b>				
	<ul style="list-style-type: none"> <li>• Black</li> </ul>	from 01.04.2015	40819	_____	/each
	<ul style="list-style-type: none"> <li>• Grey</li> </ul>	from 01.04.2015	40829	_____	/each
	<ul style="list-style-type: none"> <li>• Blue</li> </ul>	from 01.04.2015	40824	_____	/each
	<b>Dock shelter height 3500 mm</b>				
	<ul style="list-style-type: none"> <li>• Black</li> </ul>	from 01.04.2015	40820	_____	/each
	<ul style="list-style-type: none"> <li>• Grey</li> </ul>	from 01.04.2015	40830	_____	/each
	<ul style="list-style-type: none"> <li>• Blue</li> </ul>	from 01.04.2015	40825	_____	/each
	<b>Dock shelter height 3750 mm</b>				
	<ul style="list-style-type: none"> <li>• Black</li> </ul>	from 01.04.2015	40821	_____	/each
	<ul style="list-style-type: none"> <li>• Grey</li> </ul>	from 01.04.2015	40831	_____	/each
	<ul style="list-style-type: none"> <li>• Blue</li> </ul>	from 01.04.2015	40826	_____	/each
	<b>Dock shelter height 4500 mm</b>				
	<ul style="list-style-type: none"> <li>• Black</li> </ul>	from 01.04.2015	40822	_____	/each
<ul style="list-style-type: none"> <li>• Grey</li> </ul>	from 01.04.2015	40832	_____	/each	
<ul style="list-style-type: none"> <li>• Blue</li> </ul>	from 01.05.2005	40827	_____	/each	
	<b>Side cladding*</b> <b>DSL / DSS (G) / DTL / DTS</b> <b>Depth 800 mm</b> <b>Right</b> <b>Dock shelter height 3500 mm</b>			Quantity	
	<ul style="list-style-type: none"> <li>• Black</li> </ul>	from 01.04.2015	2010645	_____	/each
	<ul style="list-style-type: none"> <li>• Grey</li> </ul>	from 01.04.2015	2010646	_____	/each
	<ul style="list-style-type: none"> <li>• Blue</li> </ul>	from 01.04.2015	2010647	_____	/each
	<b>Dock shelter height 3750 mm</b>				
	<ul style="list-style-type: none"> <li>• Black</li> </ul>	from 01.04.2015	2010648	_____	/each
	<ul style="list-style-type: none"> <li>• Grey</li> </ul>	from 01.04.2015	2010649	_____	/each
	<ul style="list-style-type: none"> <li>• Blue</li> </ul>	from 01.04.2015	2010650	_____	/each
	<b>Dock shelter height 4500 mm</b>				
	<ul style="list-style-type: none"> <li>• Black</li> </ul>	from 01.04.2015	2010651	_____	/each
	<ul style="list-style-type: none"> <li>• Grey</li> </ul>	from 01.04.2015	2010652	_____	/each
	<ul style="list-style-type: none"> <li>• Blue</li> </ul>	from 01.04.2015	2010653	_____	/each

\* incl. Easy fix

<b>ORDER</b>	Customer no.: _____	Order no./com.: _____	<b>Please take information from the data label!</b>	
			<b>Order no.:</b> _____	<b>Type:</b> _____
	Customer name: _____		<b>Dock shelter / seal no.:</b> _____	<b>Year of manufacture:</b> _____
	Shipping address: _____		<b>Serial no.:</b> _____	
	Place/date: _____		Stamp and signature _____	

# Flap Shelters DS / DT

## Side cladding

Article	Description	Production period	Art. no.	Quantity	
	<b>Side cladding*</b> <b>DSL / DSS (G) / DTL / DTS</b> <b>Depth 800 mm</b> <b>Left</b>			Quantity	
	<b>Dock shelter height 3500 mm</b>				
	• Black	from 01.04.2015	2010654	_____	<b>/each</b>
	• Grey	from 01.04.2015	2010655	_____	<b>/each</b>
	• Blue	from 01.04.2015	2010656	_____	<b>/each</b>
	<b>Dock shelter height 3750 mm</b>				
	• Black	from 01.04.2015	2010657	_____	<b>/each</b>
	• Grey	from 01.04.2015	2010658	_____	<b>/each</b>
	• Blue	from 01.04.2015	2010659	_____	<b>/each</b>
	<b>Dock shelter height 4500 mm</b>				
	• Black	from 01.04.2015	2010660	_____	<b>/each</b>
	• Grey	from 01.04.2015	2010661	_____	<b>/each</b>
• Blue	from 01.04.2015	2010662	_____	<b>/each</b>	
	<b>Side cladding*</b> <b>DSL (G) / DSS (G) / DTL (G) / DTS (G)</b> <b>Depth 900 mm</b> <b>Right</b>			Quantity	
	<b>Dock shelter height 3500 mm</b>				
	• Black	from 01.05.2005	2010663	_____	<b>/each</b>
	• Grey	from 01.05.2005	2010664	_____	<b>/each</b>
	• Blue	from 01.05.2005	2010665	_____	<b>/each</b>
	<b>Dock shelter height 3750 mm</b>				
	• Black	from 01.05.2005	2010666	_____	<b>/each</b>
	• Grey	from 01.05.2005	2010667	_____	<b>/each</b>
	• Blue	from 01.05.2005	2010668	_____	<b>/each</b>
	<b>Dock shelter height 4500 mm</b>				
	• Black	from 01.05.2005	2010669	_____	<b>/each</b>
	• Grey	from 01.05.2005	2010670	_____	<b>/each</b>
	• Blue	from 01.05.2005	2010671	_____	<b>/each</b>
	<b>Side cladding*</b> <b>DSL (G) / DSS (G) / DTL (G) / DTS (G)</b> <b>Depth 900 mm</b> <b>Left</b>			Quantity	
	<b>Dock shelter height 3500 mm</b>				
	• Black	from 01.05.2005	2010672	_____	<b>/each</b>
	• Grey	from 01.05.2005	2010673	_____	<b>/each</b>
	• Blue	from 01.05.2005	2010674	_____	<b>/each</b>
<b>Dock shelter height 3750 mm</b>					
• Black	from 01.05.2005	2010675	_____	<b>/each</b>	
• Grey	from 01.05.2005	2010676	_____	<b>/each</b>	
• Blue	from 01.05.2005	2010677	_____	<b>/each</b>	
<b>Dock shelter height 4500 mm</b>					
• Black	from 01.05.2005	2010678	_____	<b>/each</b>	
• Grey	from 01.05.2005	2010679	_____	<b>/each</b>	
• Blue	from 01.05.2005	2010680	_____	<b>/each</b>	

\* incl. Easy fix

<b>ORDER</b>	Customer no.: _____ Order no./com.: _____	<b>Please take information from the data label!</b>
	Customer name: _____	<b>Order no.:</b> _____ <b>Type:</b> _____
	Shipping address: _____	<b>Dock shelter / seal no.:</b> _____ <b>Year of manufacture:</b> _____
	_____	<b>Serial no.:</b> _____
	Place/date: _____	Stamp and signature _____



# Flap Shelters DS / DT

## Top cladding

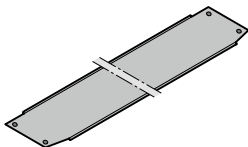
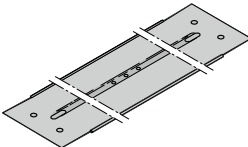
Article	Description	Production period	Art. no.	Quantity	
	<b>Top cladding</b> <b>DSL (G) / DSS (G) / DTL (G) / DTS (G)</b> <b>Depth 500 mm</b> <b>Dock shelter width 2800 mm</b>			Quantity	
	<ul style="list-style-type: none"> <li>• Black</li> </ul>	from 01.04.2015	40857	_____	/each
	<ul style="list-style-type: none"> <li>• Grey</li> </ul>	from 01.04.2015	40873	_____	/each
	<ul style="list-style-type: none"> <li>• Blue</li> </ul>	from 01.04.2015	40865	_____	/each
	<b>Dock shelter width 3000 mm</b>				
	<ul style="list-style-type: none"> <li>• Black</li> </ul>	from 01.04.2015	40858	_____	/each
	<ul style="list-style-type: none"> <li>• Grey</li> </ul>	from 01.04.2015	40874	_____	/each
	<ul style="list-style-type: none"> <li>• Blue</li> </ul>	from 01.04.2015	40866	_____	/each
	<b>Dock shelter width 3350 mm</b>				
	<ul style="list-style-type: none"> <li>• Black</li> </ul>	01.05.2005 – 31.03.2015	2010681	_____	/each
	<ul style="list-style-type: none"> <li>• Grey</li> </ul>	01.05.2005 – 31.03.2015	2010682	_____	/each
	<ul style="list-style-type: none"> <li>• Blue</li> </ul>	01.05.2005 – 31.03.2015	2010683	_____	/each
	<ul style="list-style-type: none"> <li>• Black</li> </ul>	from 01.04.2015	40860	_____	/each
	<ul style="list-style-type: none"> <li>• Grey</li> </ul>	from 01.04.2015	40876	_____	/each
	<ul style="list-style-type: none"> <li>• Blue</li> </ul>	from 01.04.2015	40868	_____	/each
	<b>Dock shelter width 3500 mm</b>				
	<ul style="list-style-type: none"> <li>• Black</li> </ul>	01.05.2005 – 31.03.2015	2010684	_____	/each
	<ul style="list-style-type: none"> <li>• Grey</li> </ul>	01.05.2005 – 31.03.2015	2010685	_____	/each
	<ul style="list-style-type: none"> <li>• Blue</li> </ul>	01.05.2005 – 31.03.2015	2010686	_____	/each
	<ul style="list-style-type: none"> <li>• Black</li> </ul>	from 01.04.2015	40859	_____	/each
<ul style="list-style-type: none"> <li>• Grey</li> </ul>	from 01.04.2015	40875	_____	/each	
<ul style="list-style-type: none"> <li>• Blue</li> </ul>	from 01.04.2015	40867	_____	/each	
	<b>Top cladding</b> <b>DSL (G) / DSS (G) /</b> <b>DTLR (G) / DTSR (G)</b> <b>Depth 500 mm</b> <b>Dock shelter width 2800 mm</b>			Quantity	
	<ul style="list-style-type: none"> <li>• Black</li> </ul>	from 01.04.2015	40779	_____	/each
	<ul style="list-style-type: none"> <li>• Grey</li> </ul>	from 01.04.2015	40795	_____	/each
	<ul style="list-style-type: none"> <li>• Blue</li> </ul>	from 01.04.2015	40787	_____	/each
	<b>Dock shelter width 3000 mm</b>				
	<ul style="list-style-type: none"> <li>• Black</li> </ul>	from 01.04.2015	40780	_____	/each
	<ul style="list-style-type: none"> <li>• Grey</li> </ul>	from 01.04.2015	40796	_____	/each
	<ul style="list-style-type: none"> <li>• Blue</li> </ul>	from 01.04.2015	40788	_____	/each
	<b>Dock shelter width 3350 mm</b>				
	<ul style="list-style-type: none"> <li>• Black</li> </ul>	from 01.04.2015	40782	_____	/each
	<ul style="list-style-type: none"> <li>• Grey</li> </ul>	from 01.04.2015	40798	_____	/each
	<ul style="list-style-type: none"> <li>• Blue</li> </ul>	from 01.04.2015	40790	_____	/each
	<b>Dock shelter width 3500 mm</b>				
	<ul style="list-style-type: none"> <li>• Black</li> </ul>	from 01.04.2015	40781	_____	/each
<ul style="list-style-type: none"> <li>• Grey</li> </ul>	from 01.04.2015	40797	_____	/each	
<ul style="list-style-type: none"> <li>• Blue</li> </ul>	from 01.04.2015	40789	_____	/each	

<b>ORDER</b>	Customer no.: _____	Order no./com.: _____	<b>Please take information from the data label!</b>	
			<b>Order no.:</b> _____	<b>Type:</b> _____
	Customer name: _____		<b>Dock shelter / seal no.:</b> _____	<b>Year of manufacture:</b> _____
	Shipping address: _____		<b>Serial no.:</b> _____	
	Place/date: _____		Stamp and signature _____	

# Flap Shelters DS / DT

## Top cladding

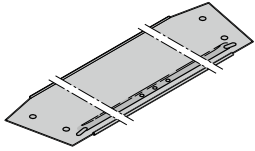
Article	Description	Production period	Art. no.	Quantity
	<b>Top cladding</b> <b>DSL (G) / DSS (G) / DTL (G) / DTS (G)</b> <b>With water run-off channel</b> <b>Depth 500 mm</b> <b>Dock shelter width 2800 mm</b>			
	<ul style="list-style-type: none"> <li>• Black from 01.04.2015 40833 _____ /each</li> <li>• Grey from 01.04.2015 40849 _____ /each</li> <li>• Blue from 01.04.2015 40841 _____ /each</li> </ul>			
	<b>Dock shelter width 3000 mm</b>			
	<ul style="list-style-type: none"> <li>• Black from 01.04.2015 40834 _____ /each</li> <li>• Grey from 01.04.2015 40850 _____ /each</li> <li>• Blue from 01.04.2015 40842 _____ /each</li> </ul>			
	<b>Dock shelter width 3350 mm</b>			
	<ul style="list-style-type: none"> <li>• Black 01.05.2005 – 31.03.2015 2010687 _____ /each</li> <li>• Grey 01.05.2005 – 31.03.2015 2010688 _____ /each</li> <li>• Blue 01.05.2005 – 31.03.2015 2010689 _____ /each</li> <li>• Black from 01.04.2015 40836 _____ /each</li> <li>• Grey from 01.04.2015 40852 _____ /each</li> <li>• Blue from 01.04.2015 40844 _____ /each</li> </ul>			
	<b>Dock shelter width 3500 mm</b>			
	<ul style="list-style-type: none"> <li>• Black 01.05.2005 – 31.03.2015 2010690 _____ /each</li> <li>• Grey 01.05.2005 – 31.03.2015 2010691 _____ /each</li> <li>• Blue 01.05.2005 – 31.03.2015 2010692 _____ /each</li> <li>• Black from 01.04.2015 40835 _____ /each</li> <li>• Grey from 01.04.2015 40851 _____ /each</li> <li>• Blue from 01.04.2015 40843 _____ /each</li> </ul>			

<b>ORDER</b>	Customer no.: _____ Order no./com.: _____	<b>Please take information from the data label!</b>
	Customer name: _____	<b>Order no.: _____ Type: _____</b>
	Shipping address: _____	<b>Dock shelter / seal no.: _____ Year of manufacture: _____</b>
	Place/date: _____	<b>Serial no.: _____</b>
		Stamp and signature

# Flap Shelters DS / DT

## Top cladding

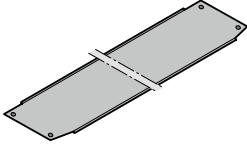
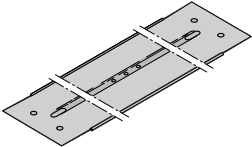
Article	Description	Production period	Art. no.	Quantity		
	<b>Top cladding</b> <b>DSL (G) / DSS (G) / DTL (G) / DTS (G)</b> <b>Depth 600 mm</b> <b>Dock shelter width 2800 mm</b>					
	<ul style="list-style-type: none"> <li>• Black</li> <li>• Grey</li> <li>• Blue</li> </ul>	from 01.04.2015 from 01.04.2015 from 01.04.2015	40861 40877 40869	_____ _____ _____	/each /each /each	
	<b>Dock shelter width 3000 mm</b>					
	<ul style="list-style-type: none"> <li>• Black</li> <li>• Grey</li> <li>• Blue</li> </ul>	from 01.04.2015 from 01.04.2015 from 01.04.2015	40862 40878 40870	_____ _____ _____	/each /each /each	
	<b>Dock shelter width 3350 mm</b>					
	<ul style="list-style-type: none"> <li>• Black</li> <li>• Grey</li> <li>• Blue</li> </ul>	01.05.2005 – 31.03.2015 01.05.2005 – 31.03.2015 01.05.2005 – 31.03.2015	2010693 2010694 2010695	_____ _____ _____	/each /each /each	
	<ul style="list-style-type: none"> <li>• Black</li> <li>• Grey</li> <li>• Blue</li> </ul>	from 01.04.2015 from 01.04.2015 from 01.04.2015	40864 40880 40872	_____ _____ _____	/each /each /each	
	<b>Dock shelter width 3500 mm</b>					
	<ul style="list-style-type: none"> <li>• Black</li> <li>• Grey</li> <li>• Blue</li> </ul>	01.05.2005 – 31.03.2015 01.05.2005 – 31.03.2015 01.05.2005 – 31.03.2015	2010696 2010697 2010698	_____ _____ _____	/each /each /each	
	<ul style="list-style-type: none"> <li>• Black</li> <li>• Grey</li> <li>• Blue</li> </ul>	from 01.04.2015 from 01.04.2015 from 01.04.2015	40863 40879 40871	_____ _____ _____	/each /each /each	
		<b>Top cladding</b> <b>DSL (G) / DSS (G) /</b> <b>DTLR (G) / DTSR (G)</b> <b>Depth 600 mm</b> <b>Dock shelter width 2800 mm</b>			Quantity	
		<ul style="list-style-type: none"> <li>• Black</li> <li>• Grey</li> <li>• Blue</li> </ul>	from 01.04.2015 from 01.04.2015 from 01.04.2015	40783 40799 40791	_____ _____ _____	/each /each /each
		<b>Dock shelter width 3000 mm</b>				
		<ul style="list-style-type: none"> <li>• Black</li> <li>• Grey</li> <li>• Blue</li> </ul>	from 01.04.2015 from 01.04.2015 from 01.04.2015	40784 40800 40792	_____ _____ _____	/each /each /each
		<b>Dock shelter width 3350 mm</b>				
		<ul style="list-style-type: none"> <li>• Black</li> <li>• Grey</li> <li>• Blue</li> </ul>	from 01.04.2015 from 01.04.2015 from 01.04.2015	40786 40802 40794	_____ _____ _____	/each /each /each
		<b>Dock shelter width 3500 mm</b>				
		<ul style="list-style-type: none"> <li>• Black</li> <li>• Grey</li> <li>• Blue</li> </ul>	from 01.04.2015 from 01.04.2015 from 01.04.2015	40785 40801 40793	_____ _____ _____	/each /each /each

<b>ORDER</b>	Customer no.: _____	Order no./com.: _____	<b>Please take information from the data label!</b>	
			<b>Order no.:</b> _____	<b>Type:</b> _____
	Customer name: _____		<b>Dock shelter / seal no.:</b> _____	<b>Year of manufacture:</b> _____
	Shipping address: _____		<b>Serial no.:</b> _____	
	Place/date: _____		Stamp and signature _____	

# Flap Shelters DS / DT

## Top cladding

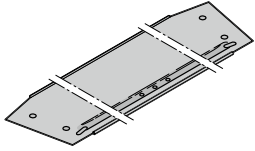
Article	Description	Production period	Art. no.	Quantity	
	<b>Top cladding</b> <b>DSL (G) / DSS (G) / DTL (G) / DTS (G)</b> <b>With water run-off channel</b> <b>Depth 600 mm</b> <b>Dock shelter width 2800 mm</b>				
	<ul style="list-style-type: none"> <li>• Black</li> <li>• Grey</li> <li>• Blue</li> </ul>	<ul style="list-style-type: none"> <li>from 01.04.2015</li> <li>from 01.04.2015</li> <li>from 01.04.2015</li> </ul>	<ul style="list-style-type: none"> <li>40837</li> <li>40853</li> <li>40845</li> </ul>	<ul style="list-style-type: none"> <li>_____</li> <li>_____</li> <li>_____</li> </ul>	<ul style="list-style-type: none"> <li><b>/each</b></li> <li><b>/each</b></li> <li><b>/each</b></li> </ul>
	<b>Dock shelter width 3000 mm</b>				
	<ul style="list-style-type: none"> <li>• Black</li> <li>• Grey</li> <li>• Blue</li> </ul>	<ul style="list-style-type: none"> <li>from 01.04.2015</li> <li>from 01.04.2015</li> <li>from 01.04.2015</li> </ul>	<ul style="list-style-type: none"> <li>40838</li> <li>40854</li> <li>40846</li> </ul>	<ul style="list-style-type: none"> <li>_____</li> <li>_____</li> <li>_____</li> </ul>	<ul style="list-style-type: none"> <li><b>/each</b></li> <li><b>/each</b></li> <li><b>/each</b></li> </ul>
	<b>Dock shelter width 3350 mm</b>				
	<ul style="list-style-type: none"> <li>• Black</li> <li>• Grey</li> <li>• Blue</li> <li>• Black</li> <li>• Grey</li> <li>• Blue</li> </ul>	<ul style="list-style-type: none"> <li>01.05.2005 – 31.03.2015</li> <li>01.05.2005 – 31.03.2015</li> <li>01.05.2005 – 31.03.2015</li> <li>from 01.04.2015</li> <li>from 01.04.2015</li> <li>from 01.04.2015</li> </ul>	<ul style="list-style-type: none"> <li>2010699</li> <li>2010700</li> <li>2010701</li> <li>40840</li> <li>40856</li> <li>40848</li> </ul>	<ul style="list-style-type: none"> <li>_____</li> <li>_____</li> <li>_____</li> <li>_____</li> <li>_____</li> <li>_____</li> </ul>	<ul style="list-style-type: none"> <li><b>/each</b></li> <li><b>/each</b></li> <li><b>/each</b></li> <li><b>/each</b></li> <li><b>/each</b></li> <li><b>/each</b></li> </ul>
	<b>Dock shelter width 3500 mm</b>				
	<ul style="list-style-type: none"> <li>• Black</li> <li>• Grey</li> <li>• Blue</li> <li>• Black</li> <li>• Grey</li> <li>• Blue</li> </ul>	<ul style="list-style-type: none"> <li>01.05.2005 – 31.03.2015</li> <li>01.05.2005 – 31.03.2015</li> <li>01.05.2005 – 31.03.2015</li> <li>from 01.04.2015</li> <li>from 01.04.2015</li> <li>from 01.04.2015</li> </ul>	<ul style="list-style-type: none"> <li>2010702</li> <li>2010703</li> <li>2010704</li> <li>40839</li> <li>40855</li> <li>40847</li> </ul>	<ul style="list-style-type: none"> <li>_____</li> <li>_____</li> <li>_____</li> <li>_____</li> <li>_____</li> <li>_____</li> </ul>	<ul style="list-style-type: none"> <li><b>/each</b></li> <li><b>/each</b></li> <li><b>/each</b></li> <li><b>/each</b></li> <li><b>/each</b></li> <li><b>/each</b></li> </ul>

<b>ORDER</b>	Customer no.: _____	Order no./com.: _____	<b>Please take information from the data label!</b>	
	Customer name: _____	Dock shelter / seal no.: _____		Year of manufacture: _____
	Shipping address: _____		Serial no.: _____	
	Place/date: _____		Stamp and signature _____	

# Flap Shelters DS / DT

## Top cladding

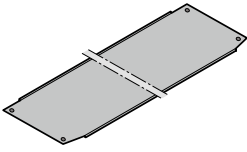
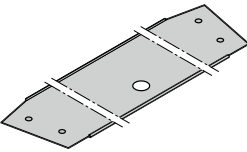
Article	Description	Production period	Art. no.	Quantity	
	<b>Top cladding</b> <b>DSL (G) / DSS (G) / DTL (G) / DTS (G)</b> <b>Depth 800 mm</b> <b>Dock shelter width 3350 mm</b>			Quantity	
	<ul style="list-style-type: none"> <li>• Black</li> </ul>	from 01.05.2005	2010705	_____	<b>/each</b>
	<ul style="list-style-type: none"> <li>• Grey</li> </ul>	from 01.04.2015	2010706	_____	<b>/each</b>
	<ul style="list-style-type: none"> <li>• Blue</li> </ul>	from 01.04.2015	2010707	_____	<b>/each</b>
	<b>Dock shelter width 3500 mm</b>				
	<ul style="list-style-type: none"> <li>• Black</li> </ul>	from 01.05.2005	2010708	_____	<b>/each</b>
<ul style="list-style-type: none"> <li>• Grey</li> </ul>	from 01.04.2015	2010709	_____	<b>/each</b>	
<ul style="list-style-type: none"> <li>• Blue</li> </ul>	from 01.04.2015	2010710	_____	<b>/each</b>	
	<b>Top cladding</b> <b>DSL (G) / DSS (G) / DTL (G) / DTS (G)</b> <b>With water run-off tube</b> <b>Depth 800 mm</b> <b>Dock shelter width 3350 mm</b>			Quantity	
	<ul style="list-style-type: none"> <li>• Black</li> </ul>	from 01.05.2005	2010711	_____	<b>/each</b>
	<ul style="list-style-type: none"> <li>• Grey</li> </ul>	from 01.04.2015	2010712	_____	<b>/each</b>
	<ul style="list-style-type: none"> <li>• Blue</li> </ul>	from 01.04.2015	2010713	_____	<b>/each</b>
	<b>Dock shelter width 3500 mm</b>				
	<ul style="list-style-type: none"> <li>• Black</li> </ul>	from 01.05.2005	2010714	_____	<b>/each</b>
<ul style="list-style-type: none"> <li>• Grey</li> </ul>	from 01.04.2015	2010715	_____	<b>/each</b>	
<ul style="list-style-type: none"> <li>• Blue</li> </ul>	from 01.04.2015	2010716	_____	<b>/each</b>	

<b>ORDER</b>	Customer no.: _____	Order no./com.: _____	<b>Please take information from the data label!</b>	
	Customer name: _____	Shipping address: _____	<b>Order no.:</b> _____	<b>Type:</b> _____
	Place/date: _____		<b>Dock shelter / seal no.:</b> _____	<b>Year of manufacture:</b> _____
			<b>Serial no.:</b> _____	
				Stamp and signature

# Flap Shelters DS / DT

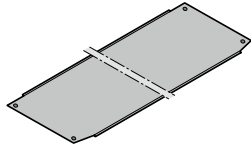
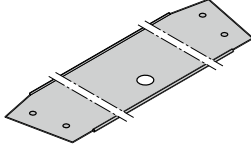

## Top cladding

Article	Description	Production period	Art. no.	Quantity	
	<b>Top cladding</b> <b>DSL (G) / DSS (G) / DTL (G) / DTS (G)</b> <b>Depth 900 mm</b>			Quantity	
	<b>Dock shelter width 2800 mm</b>				
	• Black	from 01.04.2015	40947	_____	/each
	• Grey	from 01.04.2015	40951	_____	/each
	• Blue	from 01.04.2015	40949	_____	/each
	<b>Dock shelter width 3000 mm</b>				
	• Black	from 01.04.2015	40948	_____	/each
	• Grey	from 01.04.2015	40952	_____	/each
	• Blue	from 01.04.2015	40950	_____	/each
	<b>Dock shelter width 3350 mm</b>				
	• Black	from 01.05.2005	2010717	_____	/each
	• Grey	from 01.04.2015	2010718	_____	/each
	• Blue	from 01.04.2015	2010719	_____	/each
	<b>Dock shelter width 3500 mm</b>				
	• Black	from 01.05.2005	2010720	_____	/each
• Grey	from 01.04.2015	2010721	_____	/each	
• Blue	from 01.04.2015	2010722	_____	/each	
	<b>Top cladding</b> <b>DSL (G) / DSS (G) / DTL (G) / DTS (G)</b> <b>With water run-off tube</b> <b>Depth 900 mm</b>			Quantity	
	<b>Dock shelter width 2800 mm</b>				
	• Black	from 01.04.2015	40941	_____	/each
	• Grey	from 01.04.2015	40945	_____	/each
	• Blue	from 01.04.2015	40943	_____	/each
	<b>Dock shelter width 3000 mm</b>				
	• Black	from 01.04.2015	40942	_____	/each
	• Grey	from 01.04.2015	40946	_____	/each
	• Blue	from 01.04.2015	40944	_____	/each
	<b>Dock shelter width 3350 mm</b>				
	• Black	from 01.05.2005	2010723	_____	/each
	• Grey	from 01.04.2015	2010724	_____	/each
	• Blue	from 01.04.2015	2010725	_____	/each
	<b>Dock shelter width 3500 mm</b>				
	• Black	from 01.05.2005	2010726	_____	/each
• Grey	from 01.04.2015	2010727	_____	/each	
• Blue	from 01.04.2015	2010728	_____	/each	

<b>ORDER</b>	Customer no.: _____ Order no./com.: _____	<b>Please take information from the data label!</b>
	Customer name: _____	<b>Order no.:</b> _____ <b>Type:</b> _____
	Shipping address: _____	<b>Dock shelter / seal no.:</b> _____ <b>Year of manufacture:</b> _____
	Place/date: _____	<b>Serial no.:</b> _____
		Stamp and signature _____

# Flap Shelters DS / DT

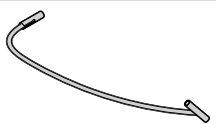
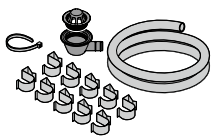
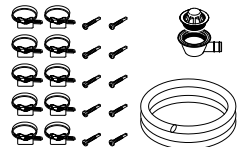
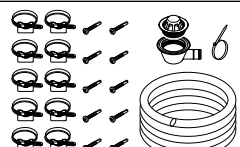
## Top cladding

Article	Description	Production period	Art. no.	Quantity	
	<b>Easy fix</b>	from 01.05.2005	309189	Quantity _____	<b>/each</b>
	<b>Water run-off set</b> For DSL/DTL	from 01.05.2005	2010729	Quantity _____	<b>/each</b>
	<b>Water run-off set</b> For DSS/DTS	from 01.05.2005	310791	Quantity _____	<b>/each</b>
	<b>Water run-off set</b> For DSS-G/DTS-G	from 01.05.2005	310792	Quantity _____	<b>/each</b>
	<b>Water run-off</b> Drain filter	from 01.05.2005	2000075	Quantity _____	<b>/each</b>
	<b>Water run-off</b> Drain support	from 01.05.2005	2000076	Quantity _____	<b>/each</b>

<b>ORDER</b>	Customer no.: _____ Order no./com.: _____	<b>Please take information from the data label!</b>
	Customer name: _____	<b>Order no.: _____ Type: _____</b>
	Shipping address: _____	<b>Dock shelter / seal no.: _____ Year of manufacture: _____</b>
	_____	<b>Serial no.: _____</b>
	Place/date: _____	Stamp and signature _____

# Flap Shelters DS / DT

## Weather strip profile

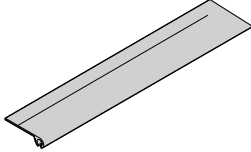
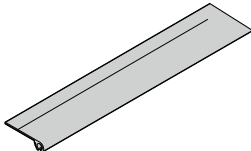
Article	Description	Production period	Art. no.	Quantity	
	<b>Weather strip profile top DSL / DTL / DSS G / DTS G</b>			Quantity	
	<b>Dock shelter width 3350 mm</b>				
	front	from 01.05.2005	307646	_____	<b>/each</b>
	rear	from 01.05.2005	307647	_____	<b>/each</b>
	<b>Dock shelter width 3500 mm</b>				
	front	from 01.05.2005	307411	_____	<b>/each</b>
	rear	from 01.05.2005	307641	_____	<b>/each</b>
		<b>Weather strip profile side DSL / DTL / DSS / DTS</b>			Quantity
<b>Dock shelter height 2800 mm</b>					
front, left		from 01.04.2015	40967	_____	<b>/each</b>
front, right		from 01.04.2015	40969	_____	<b>/each</b>
<b>Dock shelter height 3000 mm</b>					
front, left		from 01.04.2015	40968	_____	<b>/each</b>
front, right		from 01.04.2015	40970	_____	<b>/each</b>
<b>Dock shelter height 3500 mm</b>					
front, left		from 01.05.2005	307642	_____	<b>/each</b>
front, right		from 01.05.2005	307643	_____	<b>/each</b>
rear, right = left					
For depth 500 / 600 / 800 / 900 mm UPVC		from 01.05.2005	307644	_____	<b>/each</b>
<b>Dock shelter height 3750 mm</b>					
front, left		from 01.05.2005	307648	_____	<b>/each</b>
front, right		from 01.05.2005	307649	_____	<b>/each</b>
rear, right = left					
For depth 500 / 600 / 800 / 900 mm UPVC	from 01.05.2005	307650	_____	<b>/each</b>	
	<b>Weather strip profile side DSS G / DTS G</b>			Quantity	
	<b>Dock shelter height 4500 mm</b>				
	front, left	from 01.05.2005	307904	_____	<b>/each</b>
	front, right	from 01.05.2005	307905	_____	<b>/each</b>
	rear, right = left				
For depth 500 / 600 / 800 / 900 mm UPVC	from 01.05.2005	307906	_____	<b>/each</b>	

<b>ORDER</b>	Customer no.: _____	Order no./com.: _____	<b>Please take information from the data label!</b>	
	Customer name: _____	Shipping address: _____	<b>Order no.:</b> _____	<b>Type:</b> _____
	Place/date: _____	Stamp and signature _____	<b>Dock shelter / seal no.:</b> _____	<b>Year of manufacture:</b> _____
			<b>Serial no.:</b> _____	



# Flap Shelters DS / DT

## Weather strip profile

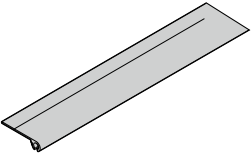
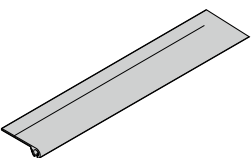
Article	Description	Production period	Art. no.	Quantity	
	<b>Weather strip profile top</b> <b>DSL (G) / DSSL (G) /</b> <b>DTL (G) / DDSL (G)</b>			Quantity	
	2800 mm, front	from 01.04.2015	311745	_____	/each
	3000 mm, front	from 01.04.2015	311746	_____	/each
	3350 mm, front	from 01.04.2015	307646	_____	/each
	3500 mm, front	from 01.04.2015	307411	_____	/each
	2800 mm, rear	from 01.04.2015	40953	_____	/each
	3000 mm, rear	from 01.04.2015	40954	_____	/each
	3350 mm, rear	from 01.04.2015	40955	_____	/each
	3500 mm, rear	from 01.04.2015	40956	_____	/each
		<b>Weather strip profile side</b> <b>DSL (G) / DSSL (G) /</b> <b>DTL (G) / DDSL (G)</b>			Quantity
<b>Dock shelter height 2800 mm</b> front, left		from 01.04.2015	40957	_____	/each
front, right		from 01.04.2015	40962	_____	/each
<b>Dock shelter height 3000 mm</b> front, left		from 01.04.2015	40958	_____	/each
front, right		from 01.04.2015	40963	_____	/each
<b>Dock shelter height 3500 mm</b> front, left		from 01.04.2015	40959	_____	/each
front, right		from 01.04.2015	40964	_____	/each
<b>Dock shelter height 3750 mm</b> front, left		from 01.04.2015	40960	_____	/each
front, right		from 01.04.2015	40965	_____	/each
<b>Dock shelter height 4500 mm</b> front, left		from 01.05.2005	40961	_____	/each
front, right		from 01.05.2005	40966	_____	/each

<b>ORDER</b>	Customer no.: _____	Order no./com.: _____	<b>Please take information from the data label!</b>	
			<b>Order no.:</b> _____	<b>Type:</b> _____
	Customer name: _____		<b>Dock shelter / seal no.:</b> _____	<b>Year of manufacture:</b> _____
	Shipping address: _____		<b>Serial no.:</b> _____	
	Place/date: _____		Stamp and signature _____	

# Flap Shelters DS / DT

## U-profile

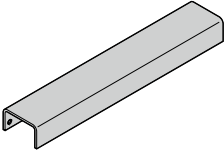
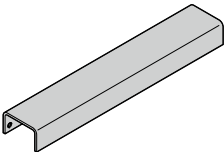
Article	Description	Production period	Art. no.	Quantity	
	<b>U-profile, top DSL / DTL</b>			Quantity	
	<b>Dock shelter width 3350 mm</b>				
	front	from 01.05.2005	307658	_____	/each
	rear	from 01.05.2005	307659	_____	/each
	<b>Dock shelter width 3500 mm</b>				
	front	from 01.05.2005	307652	_____	/each
rear	from 01.05.2005	307653	_____	/each	
	<b>U-profile, side DSL / DTL</b>			Quantity	
	<b>Dock shelter height 2800 mm Depth 500 / 600 mm</b>				
	front	from 01.04.2015	40975	_____	/each
	rear	from 01.04.2015	311747	_____	/each
	<b>Dock shelter height 3000 mm Depth 500 / 600 mm</b>				
	front	from 01.04.2015	40976	_____	/each
	rear	from 01.04.2015	311748	_____	/each
	<b>Dock shelter height 3500 mm Depth 500 / 600 mm</b>				
	front	01.05.2005 – 31.03.2015	307654	_____	/each
	front	from 01.04.2015	40977	_____	/each
	rear	from 01.05.2005	307656	_____	/each
	<b>Dock shelter height 3500 mm Depth 800 / 900 mm</b>				
	front	from 01.05.2005	2010734	_____	/each
	rear	from 01.05.2005	2010735	_____	/each
<b>Dock shelter height 3750 mm Depth 500 / 600 mm</b>					
front	01.05.2005 – 31.03.2015	307660	_____	/each	
front	from 01.04.2015	40978	_____	/each	
rear	from 01.05.2005	307718	_____	/each	
<b>Dock shelter height 3750 mm Depth 800 / 900 mm</b>					
front	from 01.05.2005	2010736	_____	/each	
rear	from 01.05.2005	2010737	_____	/each	

<b>ORDER</b>	Customer no.: _____ Order no./com.: _____	<b>Please take information from the data label!</b>
	Customer name: _____	<b>Order no.:</b> _____ <b>Type:</b> _____
	Shipping address: _____	<b>Dock shelter / seal no.:</b> _____ <b>Year of manufacture:</b> _____
	Place/date: _____	<b>Serial no.:</b> _____
		Stamp and signature _____

# Flap Shelters DS / DT

## U-profile

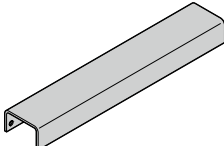
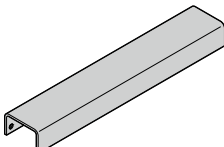
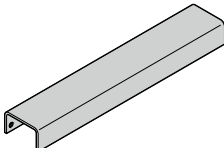
Article	Description	Production period	Art. no.	Quantity		
	<b>U-profile</b> <b>DSLRL / DTLRL</b> <b>For depth 500 / 600 mm</b>  <b>Dock shelter height 2800 mm</b> front rear <b>Dock shelter height 3000 mm</b> front rear <b>Dock shelter height 3500 mm</b> front rear <b>Dock shelter height 3750 mm</b> front rear	  from 01.04.2015 from 01.04.2015  from 01.04.2015 from 01.04.2015  from 01.04.2015 from 01.04.2015  from 01.04.2015 from 01.04.2015	  40971 311747  40972 311748  40973 307656  40974 307718	Quantity  _____ _____  _____ _____  _____ _____  _____ _____	  /each /each  /each /each  /each /each  /each /each	
		<b>U-profile, top</b> <b>DSN G</b> <b>Dock shelter width 3350 mm</b> <b>Dock shelter width 3500 mm</b>	from 01.05.2005 from 01.05.2005	308008 308005	Quantity  _____ _____	  /each /each
			<b>U-profile, side</b> <b>DSN G</b>  <b>Dock shelter height 3500 mm</b> front, left front, right <b>Dock shelter height 3750 mm</b> front, left front, right <b>Dock shelter height 3750 mm</b> front, left front, right	  from 01.05.2005 from 01.05.2005  from 01.05.2005 from 01.05.2005  from 01.05.2005 from 01.05.2005	  308006 308007  308009 308010  308011 308012	Quantity  _____ _____  _____ _____  _____ _____

<b>ORDER</b>	Customer no.: _____	Order no./com.: _____	<b>Please take information from the data label!</b>	
			<b>Order no.:</b> _____	<b>Type:</b> _____
	Customer name: _____		<b>Dock shelter / seal no.:</b> _____	<b>Year of manufacture:</b> _____
	Shipping address: _____		<b>Serial no.:</b> _____	
	Place/date: _____		Stamp and signature _____	

# Flap Shelters DS / DT

## Aluminium angle profile

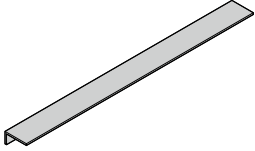
Article	Description	Production period	Art. no.	Quantity	
	<b>Aluminium angle profile, top DSN</b>			Quantity	
	<b>Dock shelter width 3350 mm</b>	from 01.05.2005	308000	_____	<b>/each</b>
	<b>Dock shelter width 3500 mm</b>	from 01.05.2005	307997	_____	<b>/each</b>
	<b>Aluminium angle profile, side DSN</b>			Quantity	
	<b>Dock shelter height 3500 mm</b>				
	Front, left	from 01.05.2005	307998	_____	<b>/each</b>
	Front, right	from 01.05.2005	307999	_____	<b>/each</b>
	<b>Dock shelter height 3750 mm</b>				
	Front, left	from 01.05.2005	308001	_____	<b>/each</b>
	Front, right	from 01.05.2005	308002	_____	<b>/each</b>
	<b>Aluminium angle profile, side DSN G</b>			Quantity	
	<b>Dock shelter height 4500 mm</b>				
	Front, left	from 01.05.2005	308003	_____	<b>/each</b>
	Front, right	from 01.05.2005	308004	_____	<b>/each</b>

<b>ORDER</b>	Customer no.: _____ Order no./com.: _____	<b>Please take information from the data label!</b>
	Customer name: _____	<b>Order no.:</b> _____ <b>Type:</b> _____
	Shipping address: _____	<b>Dock shelter / seal no.:</b> _____ <b>Year of manufacture:</b> _____
	_____	<b>Serial no.:</b> _____
	Place/date: _____	Stamp and signature _____

# Flap Shelters DS / DT

## Tubular profile

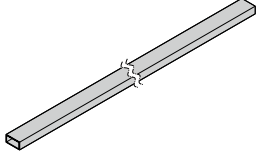
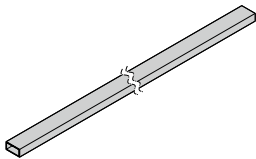
Article	Description	Production period	Art. no.	Quantity	
	<b>Tubular profile, top DSS (G) / DTS (G)</b>			Quantity	
	<b>Dock shelter width 3350 mm</b>				
	front	from 01.05.2005	307914	_____	/each
	rear	from 01.05.2005	307915	_____	/each
	<b>Dock shelter width 3500 mm</b>				
	front	from 01.05.2005	307908	_____	/each
	rear	from 01.05.2005	307909	_____	/each
		<b>Tubular profile, side DSS / DTS</b>			Quantity
<b>Dock shelter height 3500 mm</b>					
front, left		from 01.05.2005	307910	_____	/each
front, right		from 01.05.2005	307911	_____	/each
rear, left		from 01.05.2005	307912	_____	/each
rear, right		from 01.05.2005	307913	_____	/each
<b>Tubular profile, side DSS / DTS</b>				Quantity	
<b>Dock shelter height 3500 mm</b>					
front, left		from 01.04.2015	40979	_____	/each
front, right		from 01.04.2015	40982	_____	/each
rear, left		from 01.05.2005	307912	_____	/each
rear, right		from 01.05.2005	307913	_____	/each
<b>Tubular profile, side DSS / TS</b>					
<b>Dock shelter height 3750 mm</b>					
front, left		from 01.05.2005	307916	_____	/each
front, right		from 01.05.2005	307917	_____	/each
rear, left		from 01.05.2005	307918	_____	/each
rear, right		from 01.05.2005	307919	_____	/each
<b>Tubular profile, side DSS / DTS</b>					
<b>Dock shelter height 3750 mm</b>					
front, left	from 01.04.2015	40980	_____	/each	
front, right	from 01.04.2015	40983	_____	/each	
rear, left	from 01.05.2005	307918	_____	/each	
rear, right	from 01.05.2005	307919	_____	/each	
<b>Tubular profile, side DSS G / DTS G</b>				Quantity	
<b>Dock shelter height 4500 mm</b>					
front, left	from 01.05.2005	307920	_____	/each	
front, right	from 01.05.2005	307921	_____	/each	
rear, left	from 01.05.2005	307922	_____	/each	
rear, right	from 01.05.2005	307923	_____	/each	
<b>Tubular profile, side DSSR G / DTSR G</b>				Quantity	
<b>Dock shelter height 4500 mm</b>					
front, left	from 01.04.2015	40981	_____	/each	
front, right	from 01.04.2015	40984	_____	/each	
rear, left	from 01.05.2005	307922	_____	/each	
rear, right	from 01.05.2005	307923	_____	/each	

<b>ORDER</b>	Customer no.: _____	Order no./com.: _____	<b>Please take information from the data label!</b>	
			<b>Order no.:</b> _____	<b>Type:</b> _____
	Customer name: _____		<b>Dock shelter / seal no.:</b> _____	<b>Year of manufacture:</b> _____
	Shipping address: _____		<b>Serial no.:</b> _____	
	Place/date: _____		Stamp and signature _____	

# Flap Shelters DS / DT

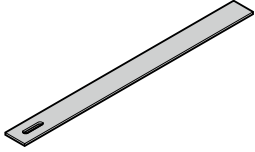
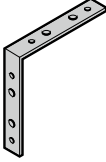
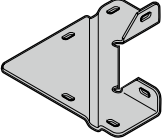
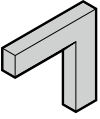
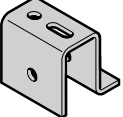
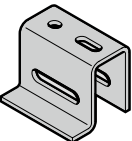
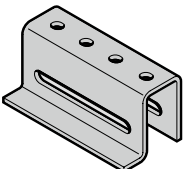

## Various spare parts

Article	Description	Production period	Art. no.	Quantity	
	<b>Leaf spring</b> 560 × 40 × 1 mm Minimum order quantity 10 pcs	from 01.05.2005	307769	Quantity _____	<b>/each</b>
	<b>Angle</b> 148 × 25 × 3 mm Minimum order quantity 10 pcs	from 01.05.2005	307882	Quantity _____	<b>/each</b>
	<b>Corner connector</b> 225 × 255 × 3 mm	from 01.05.2005	307987	Quantity _____	<b>/each</b>
	<b>Corner profile</b> 195 × 50 × 30 mm	from 01.05.2005	307883	Quantity _____	<b>/each</b>
	<b>U-piece with flange</b> 60 × 3 mm	from 01.05.2005	307762	Quantity _____	<b>/each</b>
	<b>U-piece with flange and slotted holes for 500 or 600 mm depths</b> 70 × 3 mm	from 01.05.2005	307994	Quantity _____	<b>/each</b>
	<b>U-piece with flange and slotted hole for 800 or 900 mm depths</b> 110 × 3 mm	from 01.05.2005	307996	Quantity _____	<b>/each</b>

<b>ORDER</b>	Customer no.: _____ Order no./com.: _____	<b>Please take information from the data label!</b>
	Customer name: _____	<b>Order no.:</b> _____ <b>Type:</b> _____
	Shipping address: _____	<b>Dock shelter / seal no.:</b> _____ <b>Year of manufacture:</b> _____
	_____	<b>Serial no.:</b> _____
	Place/date: _____	Stamp and signature _____

# Flap Shelters DS / DT

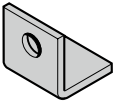
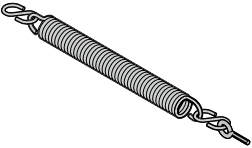
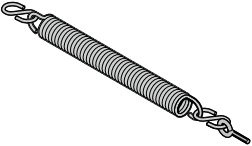
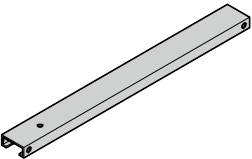

## Various spare parts

Article	Description	Production period	Art. no.	Quantity	
	<b>Scissor arm</b> 30 x 30 x 2 mm	from 01.05.2005	307771	Quantity _____	<b>/each</b>
	<b>S-shaped hook for dock shelters with scissor arm</b> 6 x 55 mm Minimum order quantity 100 pcs	from 01.05.2005	307805	Quantity _____	<b>/each</b>
	<b>Corner piece</b> 30 x 3 mm Minimum order quantity 10 pcs	from 01.05.2005	307765	Quantity _____	<b>/each</b>
	<b>Tension spring</b> for dock model	from 01.05.2005	308112	Quantity _____	<b>/each</b>
	<b>Tension spring</b> for roadway model	from 01.05.2005	307990	Quantity _____	<b>/each</b>
	<b>C profile, link arm</b> <b>For depth 500 or 600 mm</b> 1000 mm for DSL / DTL	from 01.05.2005	307884	Quantity _____	<b>/each</b>
	<b>For depth 500 or 600 mm</b> 850 mm for DSLR	from 01.07.2015	40985	Quantity _____	<b>/each</b>
	<b>For depth 800 or 900 mm</b> 1600 mm for DSL	from 01.05.2005	2010739	Quantity _____	<b>/each</b>

<b>ORDER</b>	Customer no.: _____	Order no./com.: _____	<b>Please take information from the data label!</b>	
			<b>Order no.:</b> _____	<b>Type:</b> _____
	Customer name: _____		<b>Dock shelter / seal no.:</b> _____	<b>Year of manufacture:</b> _____
	Shipping address: _____		<b>Serial no.:</b> _____	
	Place/date: _____		Stamp and signature _____	

# Flap Shelters DS / DT

## Various spare parts

Article	Description	Production period	Art. no.	Quantity	
	<b>Telescopic link arm</b> <b>For depth 500 or 600 mm</b> 1000 mm for DSL/DTL	from 01.05.2005	2010738	Quantity	/each
	<b>For depth 500 or 600 mm</b> 850 mm for DSLR	from 01.07.2015	40986	_____	/each
	<b>Delta rubber</b> Minimum order quantity 10 pcs	from 01.05.2005	308496	Quantity	/each
	<b>Fjong rubber 520</b>	01.05.2005 – 31.12.2015	41221 ↻		
	<b>Tension cable 460 mm</b>	01.10.2015 – 31.03.2016	41221 ↻		
	<b>OF tension cable 460 mm</b> Minimum order quantity 25 pcs	from 01.02.2016	41221	Quantity	/each
	<b>S-hooks for Fjong rubber</b> 4 × 50 mm Minimum order quantity 100 pcs	from 01.05.2005	307887	Quantity	/each
	<b>Set for fixing the side and top cladding</b>	from 01.07.2012	2010740	Quantity	/each
	<b>Sticker "Attention: danger of trapping"</b>	from 01.08.2006	2010741	Quantity	/each

<b>ORDER</b>	Customer no.: _____	Order no./com.: _____	<b>Please take information from the data label!</b>
	Customer name: _____	Shipping address: _____	Order no.: _____      Type: _____
	Shipping address: _____	Place/date: _____	Dock shelter / seal no.: _____      Year of manufacture: _____
	_____	_____	Serial no.: _____
	_____	_____	Stamp and signature _____



# Flap Shelters DS / DT

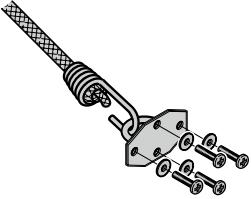
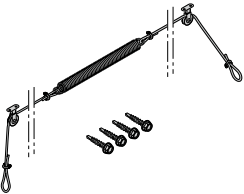
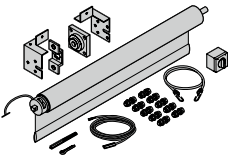
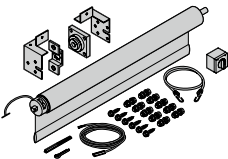
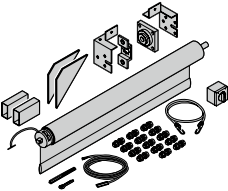
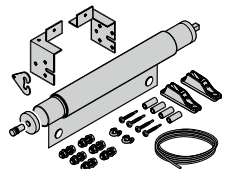

## Optional Extras

Article	Description	Production period	Art. no.	Quantity		
	<b>Storm set for dock seal</b> <b>Dock shelter height &lt; 4500 mm</b> <ul style="list-style-type: none"> <li>• Depth 500 mm</li> <li>• Depth 600 mm</li> <li>• Depth 800 mm</li> <li>• Depth 900 mm</li> </ul> <b>Dock shelter height 4500 mm</b> <ul style="list-style-type: none"> <li>• Depth 500 mm</li> <li>• Depth 600 mm</li> <li>• Depth 800 mm</li> <li>• Depth 900 mm</li> </ul>		308240 308241 308242 308243  308244 308245 308246 308247	Quantity _____ _____ _____ _____ _____ _____ _____	/each /each /each /each  /each /each /each /each	
		<b>KTP set</b> Side flap suspensions, consisting of 2 pulley wheels, cable and tension spring (instead of Fjong rubbers)		307780	Quantity _____	/each
		<b>Electric roll-up top flap</b> <b>For dock shelters with link arm</b> Dock shelter width 3350 – 3500 mm, Black, length 2000 mm	from 01.05.2005	2010742	Quantity _____	/each
		<b>Electric roll-up top flap</b> <b>For dock shelters with scissor arm</b> Dock shelter width 3350 – 3500 mm, Black, length 2000 mm	from 01.05.2005	2010743	Quantity _____	/each
		<b>Electric roll-up top flap</b> <b>For recess dock shelters</b> Dock shelter width 3350 – 3500 mm, Black, length 2000 mm	from 01.05.2005	2010744	Quantity _____	/each
		<b>Roll-up top flap, with pull cord</b> <b>For dock shelters with link arm</b> Dock shelter width 3350 – 3500 mm, Black, length 2000 mm	from 01.05.2005	2010745	Quantity _____	/each

<b>ORDER</b>	Customer no.: _____	Order no./com.: _____	<b>Please take information from the data label!</b>	
			<b>Order no.:</b> _____	<b>Type:</b> _____
	Customer name: _____		<b>Dock shelter / seal no.:</b> _____	<b>Year of manufacture:</b> _____
	Shipping address: _____		<b>Serial no.:</b> _____	
	Place/date: _____		Stamp and signature _____	

# Flap Shelters DS / DT

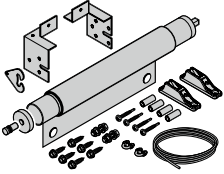
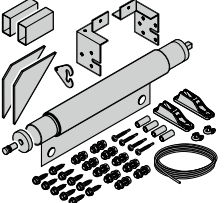
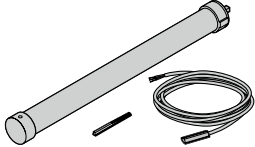
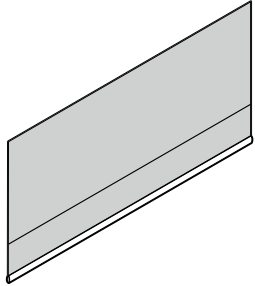
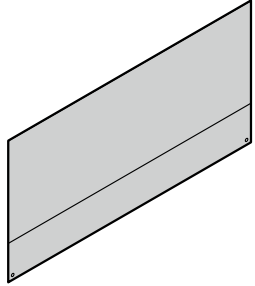

## Optional Extras

Article	Description	Production period	Art. no.	Quantity	
	<b>Roll-up top flap, with pull cord</b> <b>For dock shelters with scissor arm</b> Dock shelter width 3350 – 3500 mm, black, length 2000 mm	from 01.05.2005	2010746	Quantity _____	<b>/each</b>
	<b>Roll-up top flap, with pull cord</b> <b>For recess dock shelters</b> Dock shelter width 3350 – 3500 mm, black, length 2000 mm	from 01.05.2005	2010747	Quantity _____	<b>/each</b>
	<b>Tubular drive 230 V 260 W</b> Incl. cable and adjustment aid	from 01.05.2005	2010748	Quantity _____	<b>/each</b>
	<b>Flap for electric roll-up top flap</b>	from 01.05.2005	2010749	Quantity _____	<b>/each</b>
	<b>Flap for mechanical roll-up top flap</b>	from 01.05.2005	2010750	Quantity _____	<b>/each</b>
	<b>Cable</b> 4 mm white, length 2000 mm	from 01.05.2005	2010751	Quantity _____	<b>/each</b>

<b>ORDER</b>	Customer no.: _____	Order no./com.: _____	<b>Please take information from the data label!</b>	
	Customer name: _____	Shipping address: _____	<b>Order no.:</b> _____	<b>Type:</b> _____
	Place/date: _____	Stamp and signature _____	<b>Dock shelter / seal no.:</b> _____	<b>Year of manufacture:</b> _____
			<b>Serial no.:</b> _____	

# Flap Shelters DS / DT

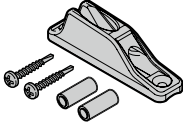
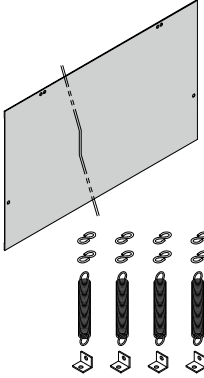
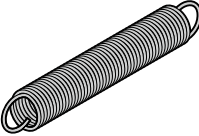
## Optional Extras

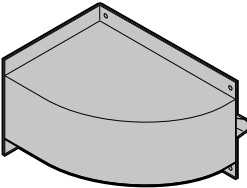
Article	Description	Production period	Art. no.	Quantity	
	<b>Tensioning rubber</b> Length 2100 mm	from 01.05.2005	2000069	Quantity _____	/each
	<b>Cable clip</b>	from 01.06.2012	2010753	Quantity _____	/each
	<b>Bottom flap</b> Height 1000 mm For dock shelter width 3350 mm black, with fitting material	from 01.05.2005	2010754	Quantity _____	/each
	Height 1300 mm For dock shelter width 3500 mm black, with fitting material	from 01.05.2005	301012	Quantity _____	/each
	Height 1000 mm For dock shelter width 3500 mm black, with fitting material	from 01.05.2005	301013	Quantity _____	/each
	<b>Tension spring for bottom flap</b>	from 01.05.2005	2010755	Quantity _____	/each
	<b>S-shaped hook for dock shelters with scissor arm</b> 6 x 55 mm Minimum order quantity 100 pcs	from 01.05.2005	307805	Quantity _____	/each
	<b>Separate corner sealing cushions incl. fitting material</b> For 500 mm depth	from 01.05.2005	308117	Quantity _____	/each
	For 600 mm depth	from 01.05.2005	308119	Quantity _____	/each
	For 900 mm depth	from 01.05.2005	2010756	Quantity _____	/each

<b>ORDER</b>	Customer no.: _____	Order no./com.: _____	<b>Please take information from the data label!</b>	
			<b>Order no.:</b> _____	<b>Type:</b> _____
	Customer name: _____		<b>Dock shelter / seal no.:</b> _____	<b>Year of manufacture:</b> _____
	Shipping address: _____		<b>Serial no.:</b> _____	
	Place/date: _____		Stamp and signature _____	

# Dock shelter DDF

## Overview of components

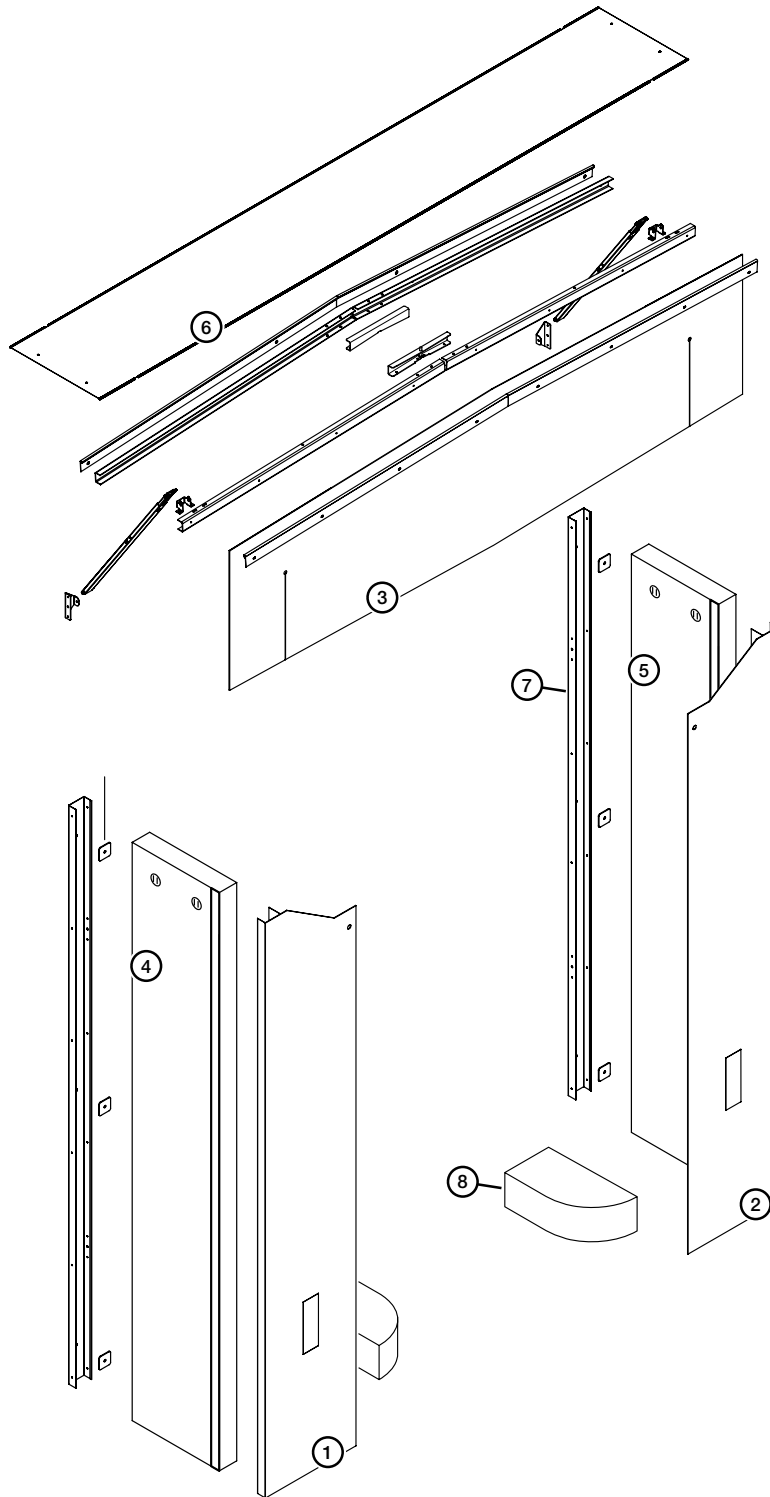



### Dock shelter DDF7

1	Side flap, left	4	Left side cushion	7	Frame profile, rear
2	Side flap, right	5	Right side cushion	8	Corner sealing cushions
3	Top flap	6	Top cladding		

# Dock shelter DDF

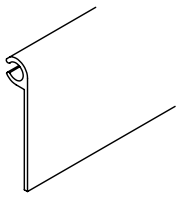
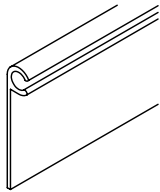
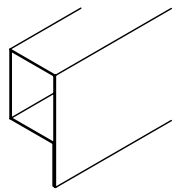
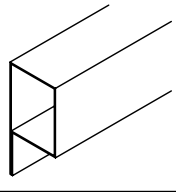
DDF until 07.07

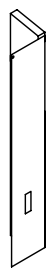
Article	Description	Production period	Art. no.	Quantity	
	<b>Weather strip profile</b> for DDF 3400 mm wide, top, front	from 01.2006 to 06.2007	308407 •	Quantity _____	<b>/each</b>
	<b>Weather strip profile</b> for DDF 3400 mm wide, top, rear	from 01.2006 to 06.2007	308048 •	Quantity _____	<b>/each</b>
	<b>Tubular profile</b> for DDF 3400 mm wide, top, front	from 08.2009	308049 •	Quantity _____	<b>/each</b>
	<b>Tubular profile</b> for DDF 3400 mm wide, top, rear	from 01.2006 to 06.2007	308050 •	Quantity _____	<b>/each</b>
	<b>Side element consisting of side cushions, pre-assembled</b> Left version	from 01.2006 to 06.2007	308051 ⌚	Quantity _____	<b>/each</b>
	<b>Side element consisting of side cushions, pre-assembled</b> Right version	from 01.2006 to 06.2007	308052 ⌚	Quantity _____	<b>/each</b>

<b>ORDER</b>	Customer no.: _____	Order no.: _____
	Customer name: _____	
	Shipping address: _____	
	Place/date: _____	Stamp and signature _____

# Dock shelter DDF

DDF until 07.07

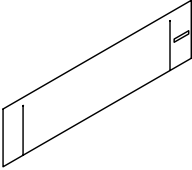
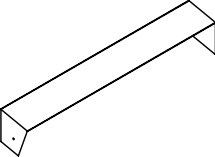
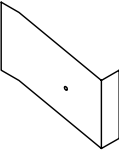
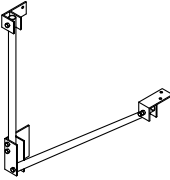
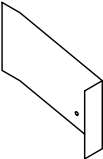
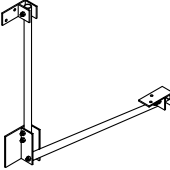
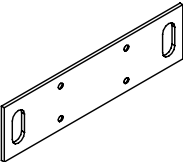
Article	Description	Production period	Art. no.	Quantity	
	<b>Top flap, cut, black</b> For DDF 3400 mm wide	from 01.2006 to 06.2007	308053 •	Quantity _____	<b>/each</b>
	<b>Top cladding, black</b> For DDF 3400 mm wide	from 01.2006 to 06.2007	308054 •	Quantity _____	<b>/each</b>
	<b>Stabiliser for DDF, black</b> Top, left	from 01.2006 to 06.2007	Replaced by art. no. 309205 ↻		
	<b>Hinge arm DDF</b> Complete on left	from 01.2012	309205	Quantity _____	<b>/each</b>
	<b>Stabiliser for DDF, black</b> Top, right	from 01.2006 to 06.2007	Replaced by art. no. 309206 ↻		
	<b>Hinge arm DDF</b> Complete on right	from 01.2012	309206	Quantity _____	<b>/each</b>
	<b>Mounting plate</b>	from 01.2006 to 06.2007	308500 •	Quantity _____	<b>/each</b>

<b>ORDER</b>	Customer no.: _____	Order no.: _____
	Customer name: _____	
	Shipping address: _____	
	Place/date: _____	Stamp and signature _____

# Dock shelter DDF



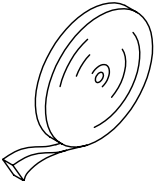
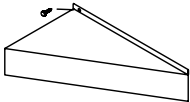







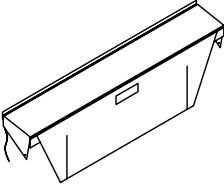

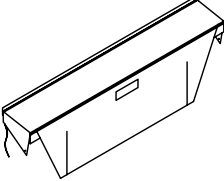
DDF until 07.07

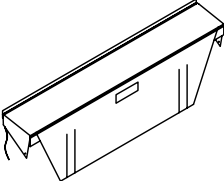
Article	Description	Production period	Art. no.	Quantity	
	<b>Rubber with spin hooks (separate)</b> Length approx. 1700 mm	from 01.2006 to 06.2007	2010752 •	Quantity _____	<b>/each</b>
	<b>Sealing strip, L-12.5 m</b>	from 01.2006 to 06.2007	308058 •	Quantity _____	<b>/each</b>
	<b>Separate corner cushion</b> Incl. fitting material	from 01.2006 to 06.2007	308120 •	Quantity _____	<b>/each</b>

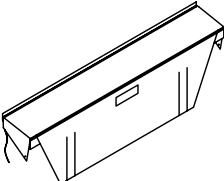
<b>ORDER</b>	Customer no.: _____ Order no.: _____	
	Customer name: _____	
	Shipping address: _____	
	Place/date: _____	Stamp and signature _____

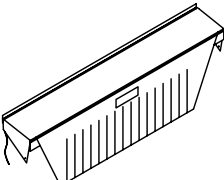
# Dock shelter DDF

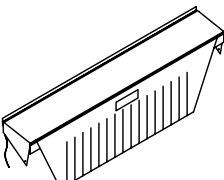
DDF from 07 – 07







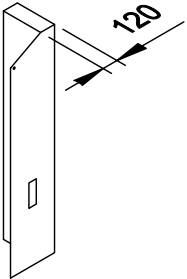

Article	Description	Production period	Art. no.	Quantity	
	<b>Complete top part</b> for DDF 3300 mm wide	from 07.2007 to 31.12.2011	308121 	Quantity _____	<b>/each</b>
	<b>Complete top part</b> for DDF 3400 mm wide	from 07.2007 to 31.12.2011	308122 	Quantity _____	<b>/each</b>
	<b>Complete top part</b> with corner-laminated top flap for DDF 3300 mm wide	from 07.2007 to 31.12.2011	308123 	Quantity _____	<b>/each</b>
	<b>Complete top part</b> with corner-laminated top flap for DDF 3400 mm wide	from 07.2007 to 31.12.2011	308124 	Quantity _____	<b>/each</b>
	<b>Complete top part</b> with double, laminated top flap for DDF 3300 mm wide	from 07.2007 to 31.12.2011	308125 	Quantity _____	<b>/each</b>
	<b>Complete top part</b> with double, laminated top flap for DDF 3400 mm wide	from 07.2007 to 31.12.2011	308126 	Quantity _____	<b>/each</b>

<b>ORDER</b>	Customer no.: _____		Order no.: _____	
	Customer name: _____			
	Shipping address: _____			
	Place/date: _____		Stamp and signature _____	

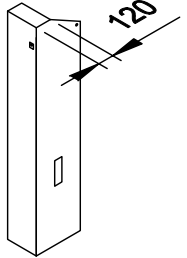

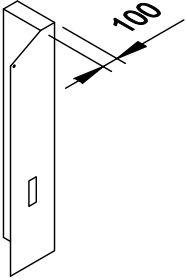
# Dock shelter DDF

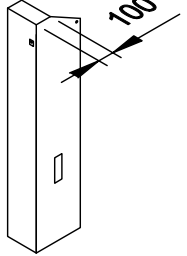

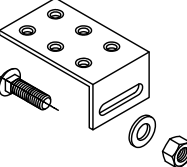
DDF from 07 – 07

Article	Description	Production period	Art. no.	Quantity	
	<b>Right side element</b> for DDF 3500 mm high Foam cushion, 120 mm wide	from 07.2007 to 01.05.2011	308127 	Quantity _____	/each
	<b>Left side element</b> for DDF 3500 mm high Foam cushion, 120 mm wide	from 07.2007 to 01.05.2011	308128 	Quantity _____	/each
	<b>Right side element</b> for DDF 3500 mm high Foam cushion, 100 mm wide	from 07.2010 to 31.12.2011	309207 	Quantity _____	/each
	<b>Left side element</b> for DDF 3500 mm high Foam cushion, 100 mm wide	from 07.2010 to 31.12.2011	309208 	Quantity _____	/each
	<b>Mounting bracket for telescopic support</b> only for cushion width 100 mm	from 07.2010 to 31.12.2011	309209 •	Quantity _____	/each

<b>ORDER</b>	Customer no.: _____	Order no.: _____
	Customer name: _____	
	Shipping address: _____	
	Place/date: _____	Stamp and signature _____

# Dock shelter DDF

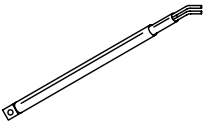
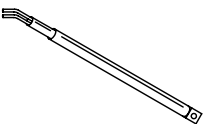

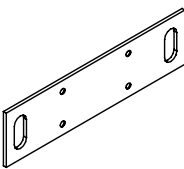
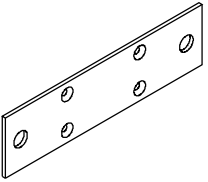
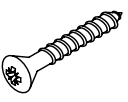
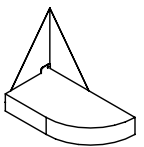
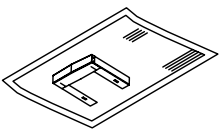
DDF from 07 – 07

Article	Description	Production period	Art. no.	Quantity	
	<b>Telescopic support, right</b>	from 07.2007 to 31.12.2011	308129 ⌚	Quantity _____	<b>/each</b>
	<b>Telescopic support, left</b>	from 07.2007 to 31.12.2011	308130 ⌚	Quantity _____	<b>/each</b>
	<b>Link cable</b>	from 07.2007 to 31.12.2011	308131 •	Quantity _____	<b>/each</b>
	<b>Mounting plate</b>	from 07.2007 to 31.12.2011	Replaced by art. no. 310793 ↻		
	<b>Mounting plate</b>	from 01.2012	310793 •	Quantity _____	<b>/each</b>
	<b>Screws for mounting plate</b> Min. order quantity: 100 pcs	from 07.2007 to 31.12.2011	308133 •	Quantity _____	<b>/each</b>
	<b>Separate corner cushion</b> Incl. fitting material	from 07.2007 to 31.12.2011	309210 •	Quantity _____	<b>/each</b>
	<b>Fitting instructions</b>			Quantity _____	

<b>ORDER</b>	Customer no.: _____	Order no.: _____
	Customer name: _____	
	Shipping address: _____	
	Place/date: _____	Stamp and signature _____

# Dock shelter DDF

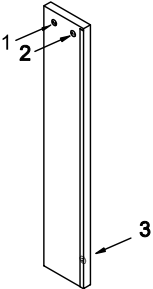
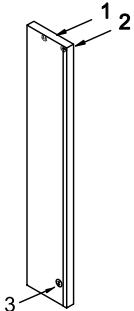

## DDF 7

Article	Description	Production period	Art. no.	Quantity
	<b>Left side element</b>	from 01.2012	Replaced by art. no. 309201 ↻	
	<b>Right side element</b>	from 01.2012	Replaced by art. no. 309201 ↻	
	<b>Left side element</b> For DDF7 with corner sealing cushion	from 14.09.2012	Replaced by art. no. 309201 ↻	
	<b>Right side element</b> For DDF7 with corner sealing cushion	from 14.09.2012	Replaced by art. no. 309201 ↻	

<b>ORDER</b>	Customer no.: _____ Order no.: _____	
	Customer name: _____	
	Shipping address: _____	
	Place/date: _____	Stamp and signature _____

# Dock shelter DDF

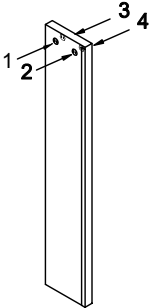
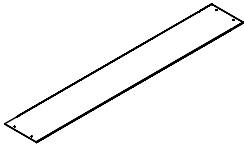
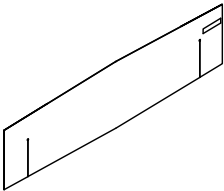
## DDF 7

Article	Description	Production period	Art. no.	Quantity	
	<b>Side element, left = right</b>	from 14.09.2012	309201 •	Quantity _____	<b>/each</b>
	<b>Weather strip top cladding</b> Dock shelter width 3300 Dock shelter width 3400 Dock shelter width 3500	from 01.2012 from 01.2012 from 01.2012	2010760 • 309174 • 2010761 •	Quantity _____ _____ _____	<b>/each</b> <b>/each</b> <b>/each</b>
	<b>Top flap, cut</b> Dock shelter width 3300 Dock shelter width 3400 Dock shelter width 3500	from 01.2012 from 01.2012 from 01.2012	2010762 • 309175 • 2010763 •	Quantity _____ _____ _____	<b>/each</b> <b>/each</b> <b>/each</b>
	<b>Side flap, right</b> For dock shelters <b>without</b> corner sealing cushions For dock shelters <b>with</b> corner sealing cushions	from 01.2012 from 01.2013	309176 • 2010764 •	Quantity _____ _____	<b>/each</b> <b>/each</b>
	<b>Side flap, left</b> For dock shelters <b>without</b> corner sealing cushions For dock shelters <b>with</b> corner sealing cushions	from 01.2012 from 01.2013	309177 • 2010765 •	Quantity _____ _____	<b>/each</b> <b>/each</b>

<b>ORDER</b>	Customer no.: _____	Order no.: _____
	Customer name: _____	
	Shipping address: _____	
	_____	
	Place/date: _____	Stamp and signature _____

# Dock shelter DDF

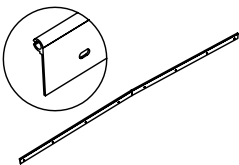
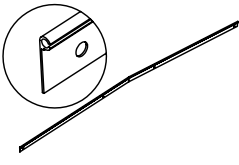
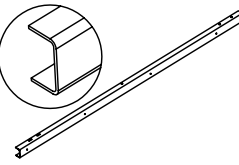
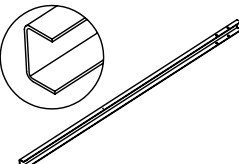
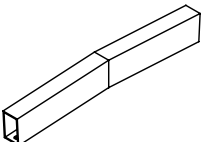
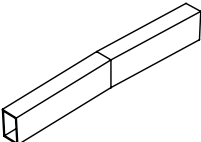
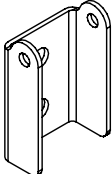

## DDF 7

Article	Description	Production period	Art. no.	Quantity	
	<b>Weather strip profile, front</b> Dock shelter width 3300 Dock shelter width 3400 Dock shelter width 3500	from 01.2012 from 01.2012 from 01.2012	2010766 • 309178 • 2010767 •	Quantity _____ _____ _____	<b>/each</b> <b>/each</b> <b>/each</b>
	<b>Weather strip profile, rear</b> Dock shelter width 3300 Dock shelter width 3400 Dock shelter width 3500	from 01.2012 from 01.2012 from 01.2012	2010768 • 309179 • 2010769 •	Quantity _____ _____ _____	<b>/each</b> <b>/each</b> <b>/each</b>
	<b>U-profile, front</b> L = 1695 mm 2 required per dock shelter Dock shelter width 3300 Dock shelter width 3400 Dock shelter width 3500	from 01.2012 from 01.2012 from 01.2012	2010770 • 309180 • 2010771 •	Quantity _____ _____ _____	<b>/each</b> <b>/each</b> <b>/each</b>
	<b>U-profile, rear</b> L = 1695 mm 2 required per dock shelter Dock shelter width 3300 Dock shelter width 3400 Dock shelter width 3500	from 01.2012 from 01.2012 from 01.2012	2010772 • 309181 • 2010773 •	Quantity _____ _____ _____	<b>/each</b> <b>/each</b> <b>/each</b>
	<b>Top connector, rear</b>	from 01.2012	309182 •	Quantity _____	<b>/each</b>
	<b>Top connector, front</b>	from 01.2012	309183 •	Quantity _____	<b>/each</b>
	<b>Link arm mounting bracket, rear</b>	01.2012 to 03.2013	309184 •	Quantity _____	<b>/each</b>

<b>ORDER</b>	Customer no.: _____	Order no.: _____
	Customer name: _____	
	Shipping address: _____	
	Place/date: _____	Stamp and signature _____

# Dock shelter DDF

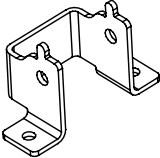
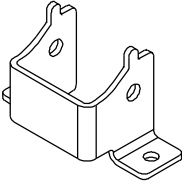
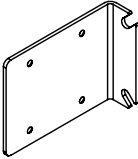
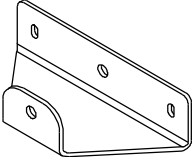
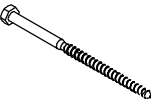

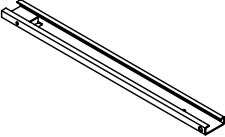
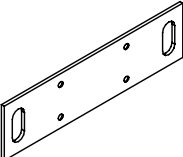
## DDF 7

Article	Description	Production period	Art. no.	Quantity	
	<b>Link arm mounting bracket, front</b>	01.2012 to 03.2013	309185 •	Quantity _____	<b>/each</b>
	<b>Link arm mounting bracket, front</b>	from 04.2013	310786 •	Quantity _____	<b>/each</b>
	<b>Mounting bracket fitting plate, rear</b>	01.2012 to 03.2013	309186 •	Quantity _____	<b>/each</b>
	<b>U-support</b>	from 04.2013	310787 •	Quantity _____	<b>/each</b>
	<b>Wood screw 8 x 150</b>	from 04.2013	310788 •	Quantity _____	<b>/each</b>
	<b>Link arm bottom part, L = 900 mm</b>	from 01.2012	309187 •	Quantity _____	<b>/each</b>
	<b>Link arm upper part, L = 470 mm</b>	from 01.2012	309188 •	Quantity _____	<b>/each</b>
	<b>Mounting plate</b>	01.2012 to 03.2013	308500 •	Quantity _____	<b>/each</b>

<b>ORDER</b>	Customer no.: _____	Order no.: _____
	Customer name: _____	
	Shipping address: _____	
	Place/date: _____	Stamp and signature _____

# Dock shelter DDF

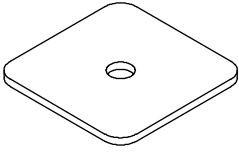
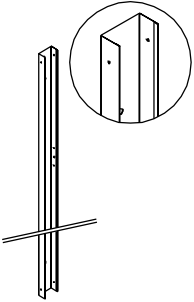
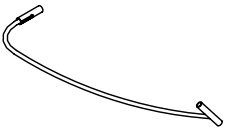
## DDF 7

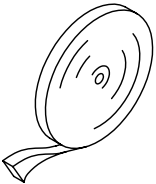
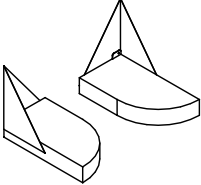
Article	Description	Production period	Art. no.	Quantity	
	<b>Mounting plate 80 x 80 x 4</b>	from 04.2013	310789 •	Quantity _____	<b>/each</b>
	<b>U-profile 100 x 50, L = 3325, black Plastisol</b>	from 04.2013	310790 •	Quantity _____	<b>/each</b>
	<b>Easy fix</b>	from 01.2012	309189 •	Quantity _____	<b>/each</b>
	<b>Rubber with spinning hook, L = 2100 mm</b>	01.2012 to 10.2012	Replaced by art. no. 309204 ↻		
	<b>Rubber with spinning hook, L = 2400 mm</b>	from 10.2012	309204 •	Quantity _____	<b>/each</b>
	<b>Sealing strip, L-12.5 m</b>	from 01.2012	308058 •	Quantity _____	<b>/each</b>
	<b>Corner sealing cushion upgrade set Incl. fitting material</b>	from 01.2012	Replaced by art. no. 2010774 ↻		

<b>ORDER</b>	Customer no.: _____		Order no.: _____	
	Customer name: _____			
	Shipping address: _____			
	Place/date: _____		Stamp and signature _____	

# Dock shelter DDF

## DDF 7

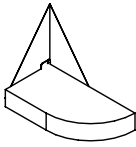
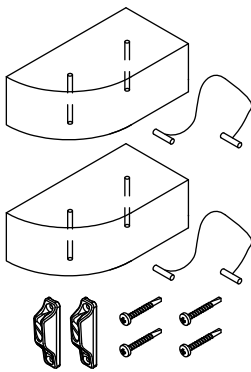
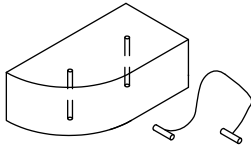
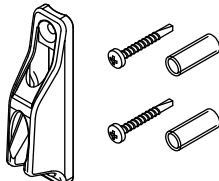
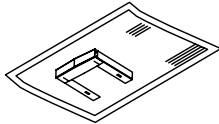
Article	Description	Production period	Art. no.	Quantity	
	<b>Separate corner cushion</b> Incl. fitting material (replacement for existing corner sealing cushions)	from 01.2012	Replaced by art. no. 2010775 ↻		
	<b>Corner sealing cushion upgrade set</b> Incl. fitting material	from 01.2012	2010774 •	Quantity _____	<b>/each</b>
	<b>Separate corner cushion</b> Incl. fitting material (replacement for existing corner sealing cushions)	from 01.2012	2010775 •	Quantity _____	<b>/each</b>
	<b>Cable clip</b>	from 01.2012	2010753 •	Quantity _____	<b>/each</b>
	<b>Fitting instructions</b> <b>Fitting instructions</b>	from 04.2013 until 04.2013	309192 •	Quantity _____ _____	<b>/each</b>

<b>ORDER</b>	Customer no.: _____	Order no.: _____
	Customer name: _____	
	Shipping address: _____	
	Place/date: _____	Stamp and signature _____



# Dock shelter DDF

## Fitting material

Article	Description	Production period	Art. no.	Quantity	
	<b>Hexagon head tapping screw 8 x 22 with flange</b> Min. order quantity: 100 pcs	from 01.2012	307795	Quantity _____	<b>/each</b>
	<b>Hexagon screw M8 x 65</b> Min. order quantity: 100 pcs	from 01.2012	309193	Quantity _____	<b>/each</b>
	<b>Lock nut M8</b> Min. order quantity: 100 pcs	from 01.2012	307778	Quantity _____	<b>/each</b>
	<b>Hexagon head tapping screw 6.3 x 16 with flange</b> Min. order quantity: 100 pcs	01.2012 to 03.2013	307823	Quantity _____	<b>/each</b>
	<b>Pan-head tapping screw Ø5 x 40</b> (min. order quantity 100 pcs)	from 04.2013	307786	Quantity _____	<b>/each</b>
	<b>Wood screw 5 x 40</b> Min. order quantity: 100 pcs	from 01.2012	307784	Quantity _____	<b>/each</b>
	<b>3/8 plug</b>	from 01.2012	309194	Quantity _____	<b>/each</b>
	<b>Allen key for 3/8 plug</b>	from 01.2012	309195	Quantity _____	<b>/each</b>
	<b>S-shaped hook</b>	from 01.2012	309196	Quantity _____	<b>/each</b>

<b>ORDER</b>	Customer no.: _____ Order no.: _____	
	Customer name: _____	
	Shipping address: _____	
	Place/date: _____	Stamp and signature _____

# Inflatable Dock Seal

## Overview of components

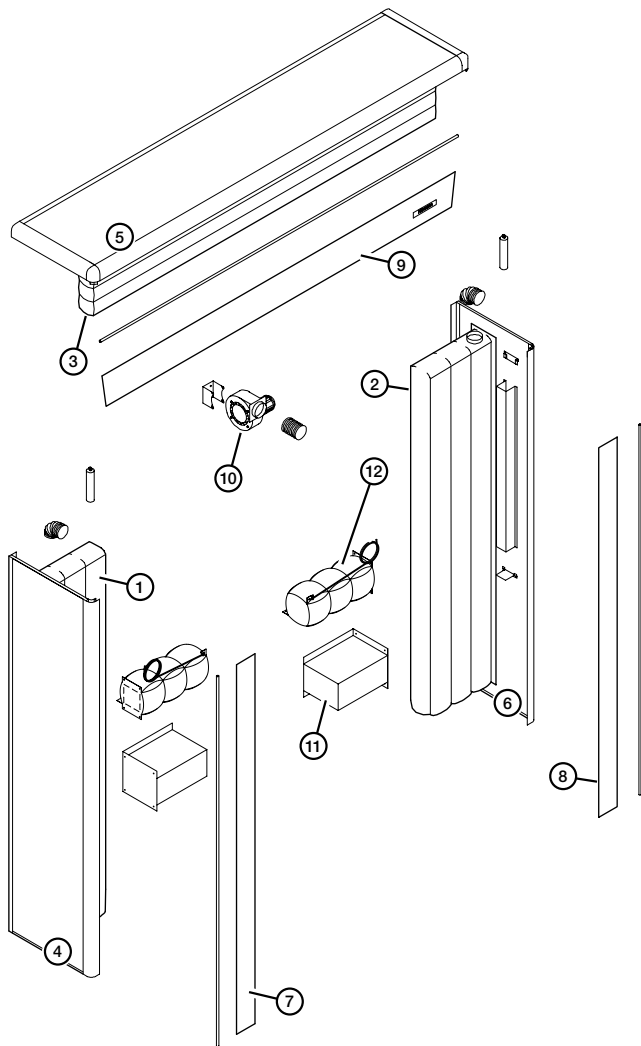

**Dock shelter DAS3**

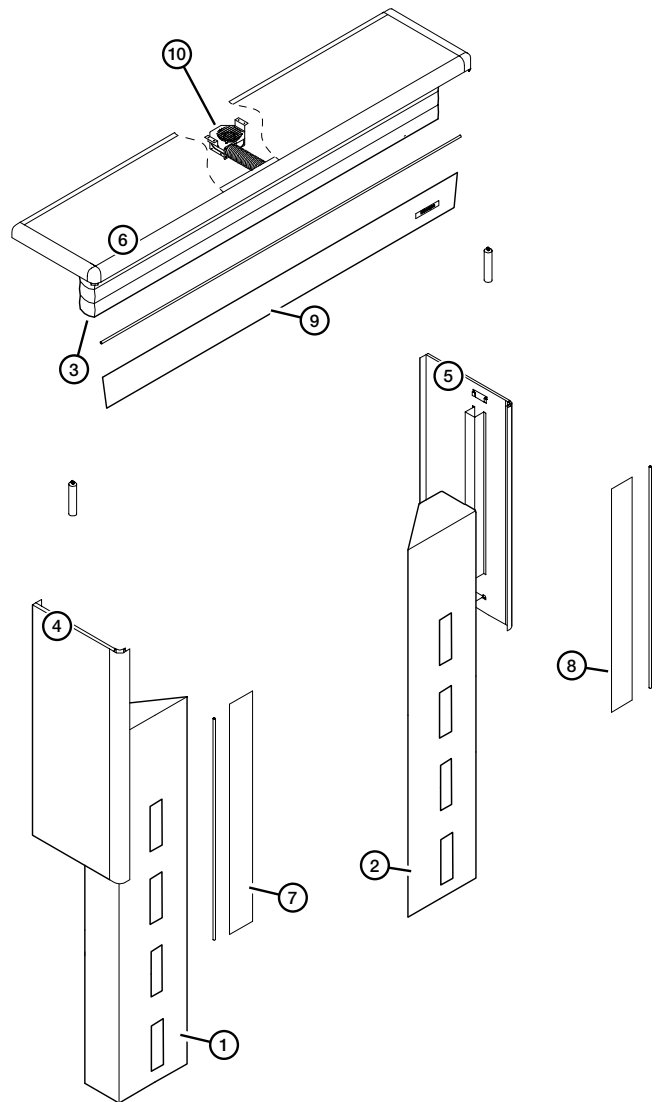

**Dock shelters and seals DAK3**

1	Left side cushion	5	Side cladding, right	9	Top flap
2	Right side cushion	6	Top cladding	10	Blower
3	Top cushion	7	Side flap, left	11	Corner sealing cushions
4	Side cladding, left	8	Side flap, right	12	Inflatable corner sealing cushion

# Inflatable Dock Seal

## DAS 3 / DAS G 3

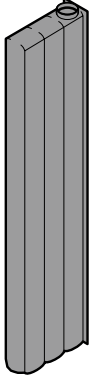
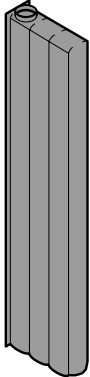
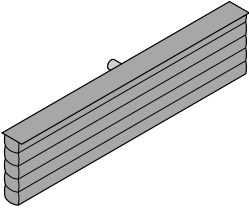
Article	Description	Production period	Art. no.	Quantity	
	<b>Right side cushion</b>			Quantity	
	<b>for DAS 3 with height 3550 mm</b>				
	Side cushion width 600 mm	from 01.10.2003	309400	_____	/each
	Side cushion width 800 mm	from 01.10.2003	309402	_____	/each
	Side cushion width 1000 mm	from 01.10.2003	309403	_____	/each
	<b>for DAS 3 with height 3850 mm</b>				
	Side cushion width 600 mm	from 01.10.2003	309401	_____	/each
	Side cushion width 800 mm	from 01.10.2003	2000072	_____	/each
	Side cushion width 1000 mm	from 01.10.2003	2000073	_____	/each
	<b>for DAS G 3 with height 4700 mm</b>				
	Side cushion width 600 mm	from 01.10.2003	309404	_____	/each
	Side cushion width 800 mm	from 01.10.2003	309405	_____	/each
Side cushion width 1000 mm	from 01.10.2003	309406	_____	/each	
	<b>Left side cushion</b>			Quantity	
	<b>for DAS 3 with height 3550 mm</b>				
	Side cushion width 600 mm	from 01.10.2003	309407	_____	/each
	Side cushion width 800 mm	from 01.10.2003	309409	_____	/each
	Side cushion width 1000 mm	from 01.10.2003	309410	_____	/each
	<b>for DAS 3 with height 3850 mm</b>				
	Side cushion width 600 mm	from 01.10.2003	309408	_____	/each
	Side cushion width 800 mm	from 01.10.2003	2000070	_____	/each
	Side cushion width 1000 mm	from 01.10.2003	2000071	_____	/each
	<b>for DAS G 3 with height 4700 mm</b>				
	Side cushion width 600 mm	from 01.10.2003	309411	_____	/each
	Side cushion width 800 mm	from 01.10.2003	309412	_____	/each
Side cushion width 1000 mm	from 01.10.2003	309413	_____	/each	
	<b>Top cushion, 3600 mm wide</b>			Quantity	
	Length = 800 mm	from 01.10.2003	307885	_____	/each
	Length = 1000 mm	from 01.10.2003	307808	_____	/each
	Length = 1200 mm	from 01.10.2003	308066	_____	/each
	Length = 1400 mm	from 01.10.2003	308067	_____	/each
	Length = 1600 mm	from 01.10.2003	308068	_____	/each
	Length = 1800 mm	from 01.10.2003	309440	_____	/each
	Length = 2000 mm	from 01.10.2003	309441	_____	/each
	Length = 2200 mm	from 01.10.2003	309442	_____	/each

<b>ORDER</b>	Customer no.: _____	Order no.: _____
	Customer name: _____	
	Shipping address: _____	
	Place/date: _____	Stamp and signature _____

# Inflatable Dock Seal

## DAS 3 / DAS G 3

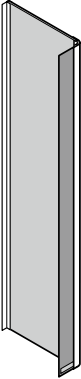
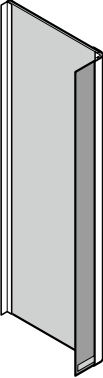
Article	Description	Production period	Art. no.	Quantity	
	<b>Side cladding, right</b> <b>Depth 850 mm</b> <b>complete</b> <b>but without preformed gasket and putty</b>			Quantity	
	<b>RAL 9002</b> for DAS 3 with height 3550 mm for DAS 3 with height 3850 mm for DAS G 3 with height 4700 mm	from 01.10.2003 from 01.10.2003 from 01.10.2003	309414 309415 309416	_____ _____ _____	/each /each /each
	<b>RAL 9006</b> for DAS 3 with height 3550 mm for DAS 3 with height 3850 mm for DAS G 3 with height 4700 mm	from 01.10.2003 from 01.10.2003 from 01.10.2003	309417 41193 309419	_____ _____ _____	/each /each /each
	<b>Side cladding, left</b> <b>Depth 850 mm</b> <b>complete</b> <b>but without preformed gasket and putty</b>			Quantity	
	<b>RAL 9002</b> for DAS 3 with height 3550 mm for DAS 3 with height 3850 mm for DAS G 3 with height 4700 mm	from 01.10.2003 from 01.10.2003 from 01.10.2003	309420 309421 309422	_____ _____ _____	/each /each /each
	<b>RAL 9006</b> for DAS 3 with height 3550 mm for DAS 3 with height 3850 mm for DAS G 3 with height 4700 mm	from 01.10.2003 from 01.10.2003 from 01.10.2003	309423 41192 309425	_____ _____ _____	/each /each /each
	<b>Side cladding, right</b> <b>Depth 1200 mm</b> <b>complete</b> <b>but without preformed gasket and putty</b>			Quantity	
	<b>RAL 9002</b> Dock shelter height 3550 mm Dock shelter height 3850 mm	from 01.10.2003 from 01.10.2003	311749 309427	⌚ _____ ⌚ _____	/each /each
	<b>RAL 9006</b> Dock shelter height 3550 mm Dock shelter height 3850 mm	from 01.10.2003 from 01.10.2003	309426 309428	⌚ _____ ⌚ _____	/each /each

<b>ORDER</b>	Customer no.: _____	Order no.: _____
	Customer name: _____	
	Shipping address: _____	
	Place/date: _____	Stamp and signature _____

# Inflatable Dock Seal



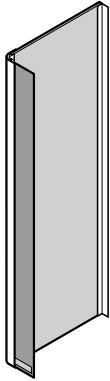
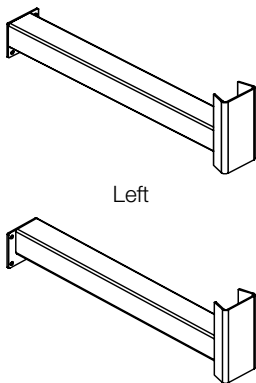
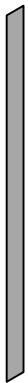

## DAS 3 / DAS G 3

Article	Description	Production period	Art. no.	Quantity			
	<b>Side cladding, left</b> <b>Depth 1200 mm</b> <b>complete</b> <b>but without preformed gasket and putty</b>  <b>RAL 9002</b> Dock shelter height 3550 mm Dock shelter height 3850 mm  <b>RAL 9006</b> Dock shelter height 3550 mm Dock shelter height 3850 mm	 from 01.10.2003 from 01.10.2003  from 01.10.2003 from 01.10.2003	 311750 309430  309429 309431	Quantity  _____ _____  _____ _____	 /each /each  /each /each		
	 Left  Right	<b>Support bracket for side cladding, galvanized, without fitting material</b> for depth 850 mm, left for depth 850 mm, right for depth 1200 mm, left for depth 1200 mm, right  <b>Fitting material for 1 support bracket</b> Fitting on steel, pedestal Fitting on concrete	from 01.10.2003 from 01.10.2003 from 01.10.2003 from 01.10.2003  from 01.10.2003 from 01.10.2003	311751 311752 200086 200087  2000088 2000089	Quantity  _____ _____ _____ _____  Quantity  _____ _____	/each /each /each /each  /each /each	
			<b>Front strips for side cladding</b> <b>Black</b> for DAS3 with height 3550 mm for DAS3 with height 3850 mm for DAS-G3 with height 4700 mm  <b>Black with markings, right</b> for DAS3 with height 3550 mm for DAS3 with height 3850 mm for DAS-G3 with height 4700 mm  <b>Black with markings, left</b> for DAS3 with height 3550 mm for DAS3 with height 3850 mm for DAS-G3 with height 4700 mm	from 01.10.2003 from 01.10.2003 from 01.10.2003  from 01.10.2003 from 01.10.2003 from 01.10.2003  from 01.10.2003 from 01.10.2003 from 01.10.2003	308135 309432 308136  41118 41119 41120  41121 41122 41123	Quantity  _____ _____ _____  Quantity  _____ _____ _____  Quantity  _____ _____ _____	/each /each /each  /each /each /each  /each /each /each

<b>ORDER</b>	Customer no.: _____	Order no.: _____
	Customer name: _____	
	Shipping address: _____	
	_____	
	Place/date: _____	Stamp and signature _____

# Inflatable Dock Seal

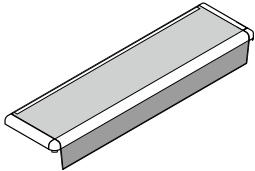



## DAS 3 / DAS G 3

Article	Description	Production period	Art. no.	Quantity	
	<b>Aluminium tube Ø 18 mm</b> for DAS3 side cladding Dock seal height ≤ 3550 mm	from 01.10.2003	308175	Quantity _____	<b>/each</b>
	for DAS-G3 side cladding Dock seal height > 3551 mm	from 01.10.2003	308176	Quantity _____	<b>/each</b>
	<b>Aluminium round profile</b> for DAS3 side cladding Dock seal height ≤ 3550 mm	from 01.10.2003	308177	Quantity _____	<b>/each</b>
	for DAS3 side cladding Dock seal height 3551 mm to 3850 mm	from 01.10.2003	309433	Quantity _____	<b>/each</b>
	for DAS-G3 side cladding dock seal height 3851 mm to 4700 mm	from 01.10.2003	308178	Quantity _____	<b>/each</b>
	<b>Top cladding</b> <b>Dock shelter width 3600 mm</b> <b>complete</b> <b>but without preformed gasket and putty</b>				
	<b>Depth 850 mm</b>			Quantity	
	RAL 9002	from 01.10.2003	308155	_____	<b>/each</b>
	RAL 9006	from 01.10.2003	308154	_____	<b>/each</b>
	<b>Depth 1200 mm</b>			Quantity	
	RAL 9002	from 01.10.2003	309434	_____	<b>/each</b>
RAL 9006	from 01.10.2003	309435	_____	<b>/each</b>	
	<b>Aluminium round profile</b> for top cladding Dock shelter width 3600 mm	from 01.10.2003	309884	Quantity _____	<b>/each</b>

<b>ORDER</b>	Customer no.: _____	Order no.: _____
	Customer name: _____	
	Shipping address: _____	
	Place/date: _____	Stamp and signature _____

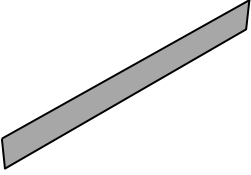
# Inflatable Dock Seal

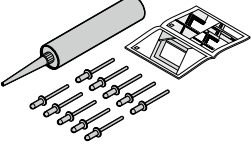
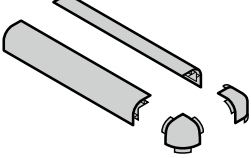

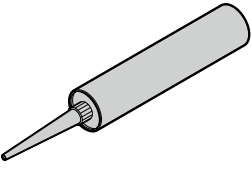
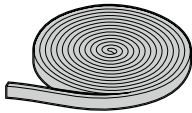
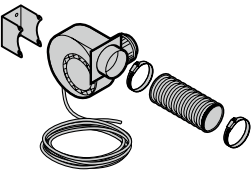

## DAS 3 / DAS G 3

Article	Description	Production period	Art. no.	Quantity	
	<b>Black front strip for top cladding width 3600 mm</b> 350 mm high Top cushion length ≤ 1200 mm	from 01.10.2003	308137 •	Quantity _____	/each
	410 mm high Top cushion length ≤ 1400 mm	from 01.10.2003	309883	_____	/each
	450 mm high Top cushion length > 1401 mm	from 01.10.2003	309437	_____	/each
	<b>Aluminium tube Ø 18 mm</b> for top cladding Dock shelter width 3600 mm	from 01.10.2003	308138	Quantity _____	/each
	<b>Aluminium round profile fitting set</b> (only required for top aluminium round profile)	from 01.10.2003	309889 •	Quantity _____	/each
	<b>Aluminium round profile and corner piece set</b> for dock seal depth 850 mm for dock seal depth 1200 mm	from 01.10.2003	307801 •	Quantity _____	/each
		from 01.10.2003	309436	_____	/each
	<b>Corner piece for aluminium round profile</b>	from 01.10.2003	41124 •	Quantity _____	/each
	<b>Grey polyurethane putty</b>	from 01.10.2003	309821 •	Quantity _____	/each
	<b>Preformed gasket 10/2 L12500</b>	from 01.10.2003	308058 •	Quantity _____	/each
	<b>Complete blower set</b> 230 V / 50 Hz, with 6 m connection cable	from 01.10.2003	307796 •	Quantity _____	/each
	230 V / 50 Hz, with 12 m connection cable	from 01.10.2003	2000084 •	_____	/each
	230 V / 60 Hz, with 6 m connection cable	from 01.10.2003	309438 ⏳	_____	/each
	230 V / 60 Hz, with 12 m connection cable	from 01.10.2003	2000085 ⏳	_____	/each

<b>ORDER</b>	Customer no.: _____	Order no.: _____
	Customer name: _____	
	Shipping address: _____	
	Place/date: _____	Stamp and signature _____

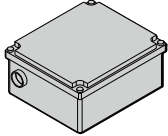
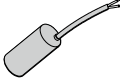
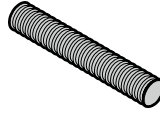
# Inflatable Dock Seal

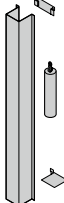
## DAS 3 / DAS G 3

Article	Description	Production period	Art. no.	Quantity	
	<b>Connection housing</b> for blower	from 01.10.2003	2000062	Quantity • _____	/each
	<b>Capacitor</b> for blower	from 01.10.2003	2000063	Quantity • _____	/each
	<b>Air hose</b> by piece (length 1.5 m)	from 01.10.2003	307791	Quantity • _____	/each
	by metre (in units per 10 m length)	from 01.10.2003	309439	Metres • _____	/m
	<b>Hose clamp</b> 60 – 135 mm	from 01.10.2003	309378	Quantity • _____	/each
	<b>Complete counter weight</b> for top cushion lengths up to 1000 mm	from 01.10.2003	308069	Quantity • _____	/each
	for top cushion length 1200 mm	from 01.10.2003	308070	• _____	/each
	for top cushion length 1400 mm	from 01.10.2003	308071	• _____	/each
	for top cushion length 1600 mm	from 01.10.2003	308072	• _____	/each
	for top cushion length 1800 mm	from 01.10.2003	309443	• _____	/each
	for top cushion length 2000 mm	from 01.10.2003	309444	• _____	/each
	for top cushion length 2200 mm	from 01.10.2003	309445	• _____	/each
	<b>Single counter weight</b> for top cushion lengths up to 1000 mm	from 01.10.2003	308073	Quantity • _____	/each
	for top cushion length 1200 mm	from 01.10.2003	308074	• _____	/each
	for top cushion length 1400 mm	from 01.10.2003	308075	• _____	/each
	for top cushion length 1600 mm and 1800 mm	from 01.10.2003	308076	• _____	/each
	for top cushion length 2000 mm	from 01.10.2003	309447	• _____	/each
	for top cushion length 2200 mm	from 01.10.2003	309448	• _____	/each
		<b>Counter weight cover cap</b> for top cushion lengths up to 1000 mm	from 01.10.2003	308077	Quantity • _____
for top cushion length 1200 mm to 1600 mm		from 01.10.2003	308078	• _____	/each
for top cushion length 1800 mm to 2200 mm		from 01.10.2003	309451	• _____	/each

<b>ORDER</b>	Customer no.: _____	Order no.: _____
	Customer name: _____	
	Shipping address: _____	
	Place/date: _____	Stamp and signature _____



# Inflatable Dock Seal

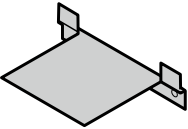
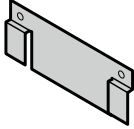
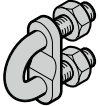
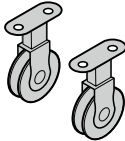
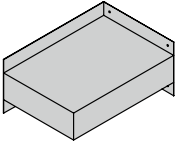
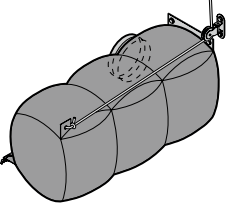
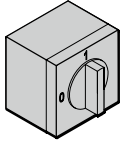
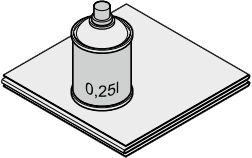

DAS 3 / DAS G 3

Article	Description	Production period	Art. no.	Quantity	
	<b>Bottom bracket for counter weight cover cap</b>	from 01.10.2003	308079 •	Quantity _____	/each
	<b>Top bracket for counter weight cover cap</b>	from 01.10.2003	308080 •	Quantity _____	/each
	<b>Cable clip M5</b>	from 01.10.2003	310619	Quantity _____	/each
	<b>Pulley wheels for top cushion</b> Set with 2 pieces	from 01.10.2003	308171 •	Quantity _____	/each
	<b>Corner sealing cushions</b> Side cushion width 600 mm, dock seal depth 850 mm	from 01.10.2003	308047 •	Quantity _____	/each
	Side cushion width 600 mm, dock seal depth 1200 mm	from 01.10.2003	309452 ⌚	Quantity _____	/each
	<b>Inflatable corner sealing cushion, Width 550 mm</b> Left, for dock seal depth 850 mm	from 01.10.2003	309453 ⌚	Quantity _____	/each
	Right, for dock seal depth 850 mm	from 01.10.2003	309454 ⌚	Quantity _____	/each
	Left, for dock seal depth 1200 mm	from 01.10.2003	309455 ⌚	Quantity _____	/each
	Right, for dock seal depth 1200 mm	from 01.10.2003	309456 ⌚	Quantity _____	/each
	<b>Switch, 4 pin</b> In a separate housing	from 01.10.2003	309083 •	Quantity _____	/each
	<b>Repair kit for cushions</b> Consisting of a 1 m <sup>2</sup> tarp and glue	from 01.10.2003	308174 •	Quantity _____	/each

<b>ORDER</b>	Customer no.: _____	Order no.: _____
	Customer name: _____	
	Shipping address: _____	
	Place/date: _____	Stamp and signature _____

# Inflatable Dock Seal

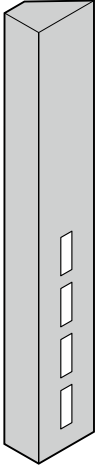
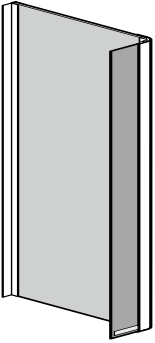



## DAK 3

Article	Description	Production period	Art. no.	Quantity	
	<b>Side cushion DAK3</b> <b>Length 3400 mm</b> Black / white, left Black / white, right	from 01.10.2003 from 01.10.2003	308139 309882	Quantity _____ _____	/each /each
		<b>Side cladding</b> <b>Depth 850 mm</b> <b>complete</b> <b>but without preformed gasket and putty</b>  <b>for top cushion lengths up to 1000 mm</b> Right RAL 9006 RAL 9002 Left RAL 9002 RAL 9006  <b>for top cushion lengths over 1000 mm</b> Right RAL 9002 RAL 9006 Left RAL 9002 RAL 9006	from 01.10.2003 from 01.10.2003 from 01.10.2003 from 01.10.2003  from 01.10.2003 from 01.10.2003 from 01.10.2003 from 01.10.2003	308140 308141 308143 308142  308145 308144 308147 308146	Quantity _____ _____ _____ _____  _____ _____ _____ _____
	<b>Black front strip</b> for DAK3 side cladding for top cushions up to 1000 mm length  for DAK3 side cladding for top cushions over 1000 mm length	from 01.10.2003 from 01.10.2003	308148 • 308149 •	Quantity _____ _____	/each /each

<b>ORDER</b>	Customer no.: _____	Order no.: _____
	Customer name: _____	
	Shipping address: _____	
	Place/date: _____	Stamp and signature _____

# Inflatable Dock Seal

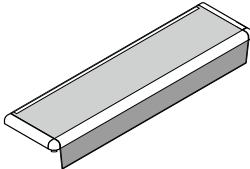

## DAK 3

Article	Description	Production period	Art. no.	Quantity	
	<b>Aluminium tube Ø 18 mm</b> for DAK3 side cladding for top cushions up to 1000 mm length	from 01.10.2003	308150 •	Quantity _____	<b>/each</b>
	for DAK3 side cladding for top cushions over 1000 mm length	from 01.10.2003	308151 •	Quantity _____	<b>/each</b>
	<b>Aluminium round profile</b> for DAK3 side cladding for top cushions up to 1000 mm length	from 01.10.2003	308152 •	Quantity _____	<b>/each</b>
	for DAK3 side cladding for top cushions over 1000 mm length	from 01.10.2003	308153 •	Quantity _____	<b>/each</b>
	<b>Complete top cladding but without preformed gasket and putty Depth = 850 mm</b>			Quantity	
	RAL 9002 Dock shelter width 3600 mm	from 01.10.2003	308155	_____	<b>/each</b>
	RAL 9006 Dock shelter width 3600 mm	from 01.10.2003	308154	_____	<b>/each</b>
	<b>Depth = 1200 mm</b>				
	<b>Aluminium round profile</b> For top cladding, door seal width 3600 mm	from 01.10.2003	309434 ⌚	Quantity _____	<b>/each</b>
			309435 ⌚	Quantity _____	<b>/each</b>
			309884	Quantity _____	<b>/each</b>

<b>ORDER</b>	Customer no.: _____ Order no.: _____	
	Customer name: _____	
	Shipping address: _____	
	Place/date: _____	Stamp and signature _____

# Inflatable Dock Seal

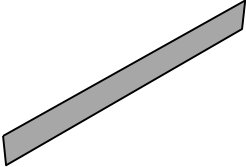
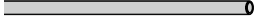
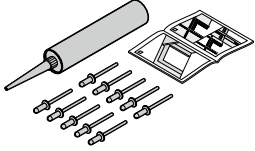
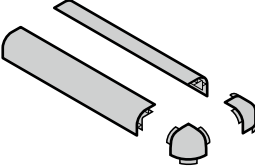

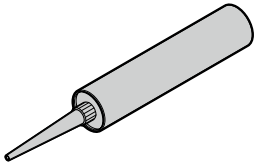
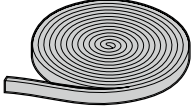
## DAK 3

Article	Description	Production period	Art. no.	Quantity	
	<b>Black front strip</b> For top cladding 350 mm high For top cushion length ≤ 1200 mm Dock shelter width 3600 mm	from 01.10.2003	308137	Quantity _____	<b>/each</b>
	For top cladding 410 mm high For top cushion length ≤ 1400 mm Dock shelter width 3600 mm	from 01.10.2003	309883	Quantity _____	<b>/each</b>
	For top cladding 450 mm high For top cushion length > 1401 mm Dock shelter width 3600 mm	from 01.10.2003	309437	Quantity _____	<b>/each</b>
	<b>Aluminium tube Ø 18 mm</b> For top cladding Dock shelter width 3600 mm	from 01.10.2003	308138	Quantity _____	<b>/each</b>
	<b>Aluminium round profile fitting set</b> (only required for top aluminium round profile)	from 01.10.2003	309889 •	Quantity _____	<b>/each</b>
	<b>Aluminium round profile and corner piece set</b> For dock seal depth 850 mm	from 01.10.2003	307801 •	Quantity _____	<b>/each</b>
	For dock seal depth 1200 mm	from 01.10.2003	309436	Quantity _____	<b>/each</b>
	<b>Corner piece for aluminium round profile</b>	from 01.10.2003	41124 •	Quantity _____	<b>/each</b>
	<b>Grey polyurethane putty</b>	from 01.10.2003	309821 •	Quantity _____	<b>/each</b>
	<b>Preformed gasket 10/2 L12500</b>	from 01.10.2003	308058 •	Quantity _____	<b>/each</b>

<b>ORDER</b>	Customer no.: _____	Order no.: _____
	Customer name: _____	
	Shipping address: _____	
	Place/date: _____	Stamp and signature _____

# Inflatable Dock Seal

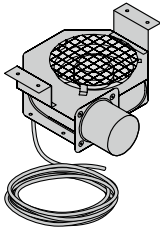
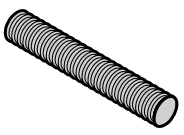
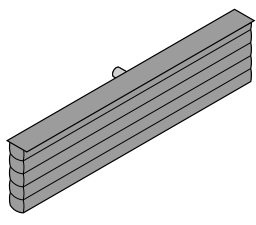
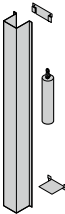
## DAK 3

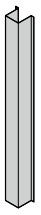
Article	Description	Production period	Art. no.	Quantity	
	<b>Blower 230 V – 50 Hz for DAK3</b> (without air hose)	from 01.10.2003	308156	Quantity • _____	<b>/each</b>
	<b>Air hose</b> By piece (length 1.5 m)  By metre (in units per 10 m length)	from 01.10.2003  from 01.10.2003	308157  311384	Quantity • _____ Metres • _____	<b>/each</b>  <b>/m</b>
	<b>Dock seal top cushion</b> <b>3600 mm wide</b> Length = 800 mm Length = 1000 mm Length = 1200 mm Length = 1400 mm Length = 1600 mm	from 01.10.2003 from 01.10.2003 from 01.10.2003 from 01.10.2003 from 01.10.2003	308159 308158 308160 308161 308162	Quantity _____ _____ _____ _____ _____	<b>/each</b> <b>/each</b> <b>/each</b> <b>/each</b> <b>/each</b>
	<b>Complete counter weight</b> For top cushion lengths up to 1000 mm For top cushion length 1200 mm For top cushion length 1400 mm For top cushion length 1600 mm	from 01.10.2003 from 01.10.2003 from 01.10.2003 from 01.10.2003	308069 308070 308071 308072	Quantity • _____ • _____ • _____ • _____	<b>/each</b> <b>/each</b> <b>/each</b> <b>/each</b>
	<b>Single counter weight</b> For top cushion lengths up to 1000 mm For top cushion length 1200 mm For top cushion length 1400 mm For top cushion length 1600 mm	from 01.10.2003 from 01.10.2003 from 01.10.2003 from 01.10.2003	308073 308074 308075 308076	Quantity • _____ • _____ • _____ • _____	<b>/each</b> <b>/each</b> <b>/each</b> <b>/each</b>
	<b>Counter weight cover cap</b> For top cushion lengths up to 1000 mm For top cushion length 1200 mm to 1600 mm	from 01.10.2003  from 01.10.2003	308077  308078	Quantity • _____  • _____	<b>/each</b>  <b>/each</b>

<b>ORDER</b>	Customer no.: _____	Order no.: _____
	Customer name: _____	
	Shipping address: _____	
	_____	
	Place/date: _____	Stamp and signature _____

# Inflatable Dock Seal



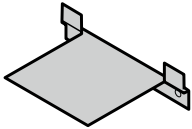
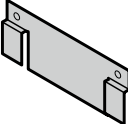
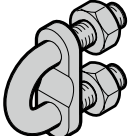
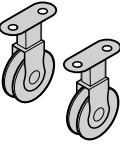
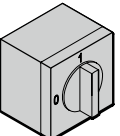
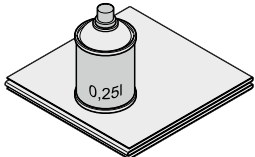

## DAK 3

Article	Description	Production period	Art. no.	Quantity	
	<b>Bottom bracket for counter weight cover cap</b>	from 01.10.2003	308079 •	Quantity _____	<b>/each</b>
	<b>Top bracket for counter weight cover cap</b>	from 01.10.2003	308080 •	Quantity _____	<b>/each</b>
	<b>Cable clip M5</b>	from 01.10.2003	310619	Quantity _____	<b>/each</b>
	<b>Pulley wheels for top cushion</b> Set with 2 pieces	from 01.10.2003	308171 •	Quantity _____	<b>/each</b>
	<b>Switch, 4 pin</b> in a separate housing	from 01.10.2003	309083 •	Quantity _____	<b>/each</b>
	<b>Repair kit for cushions</b> consisting of a 1 m <sup>2</sup> tarp and glue	from 01.10.2003	308174 •	Quantity _____	<b>/each</b>

<b>ORDER</b>	Customer no.: _____ Order no.: _____	
	Customer name: _____	
	Shipping address: _____	
	Place/date: _____	Stamp and signature _____

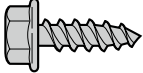
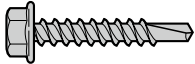
# Inflatable Dock Seal

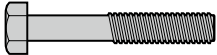



## Fitting material

Article	Description	Production period	Art. no.	Quantity	
	<b>Hexagon head tapping screw 6.3 x 16 with flange</b> Min. order quantity: 100 pcs	from 01.10.2003	307823 •	Quantity _____	<b>/each</b>
	<b>Hexagon head tapping screw 7.9 x 19 with flange</b> Min. order quantity: 100 pcs	from 01.10.2003	307795 •	Quantity _____	<b>/each</b>
	<b>Self-tapping hexagon screw</b> Min. order quantity: 100 pcs 6.3 x 38 with sealing ring 6.3 x 32 with sealing ring	from 01.10.2003 from 01.10.2003	307889 • 311613 •	Quantity _____ Quantity _____	<b>/each</b> <b>/each</b>
	<b>Wood screw 5 x 40</b> Min. order quantity: 100 pcs	from 01.10.2003	307784 •	Quantity _____	<b>/each</b>
	<b>Hexagon screw M8 x 50</b> Min. order quantity: 100 pcs	from 01.10.2003	307788 •	Quantity _____	<b>/each</b>
	<b>Hexagon screw M8 x 70</b> Min. order quantity: 100 pcs	from 01.10.2003	308109 •	Quantity _____	<b>/each</b>

<b>ORDER</b>	Customer no.: _____ Order no.: _____	
	Customer name: _____	
	Shipping address: _____	
	Place/date: _____	Stamp and signature _____

# Inflatable Dock Seal

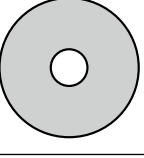
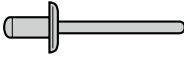
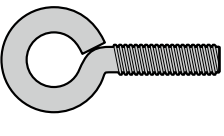
## Fitting material

Article	Description	Production period	Art. no.	Quantity	
	<b>Lock nut M8</b> min. order quantity: 100 pcs	from 01.10.2003	307778 •	Quantity _____	<b>/each</b>
	<b>Retaining ring</b> min. order quantity: 100 pcs	from 01.10.2003	307779 •	Quantity _____	<b>/each</b>
	<b>Plain washer</b> min. order quantity: 100 pcs M6 M8	from 01.10.2003 from 01.10.2003	307775 • 307144 •	Quantity _____ _____	<b>/each</b> <b>/each</b>
	<b>Blind rivet</b> min. order quantity: 100 pcs 4.8 × 9 4.8 × 18, waterproof 4.8 × 35	from 01.10.2003 from 01.10.2003 from 01.10.2003	307891 • 308499 • 308498 •	Quantity _____ _____ _____	<b>/each</b> <b>/each</b> <b>/each</b>
	<b>Eye bolt M8 × 40</b> min. order quantity: 100 pcs	from 01.10.2003	307991 •	Quantity _____	<b>/each</b>
	<b>Hex nut M8</b> min. order quantity: 100 pcs	from 01.10.2003	307776 •	Quantity _____	<b>/each</b>

<b>ORDER</b>	Customer no.: _____	Order no.: _____
	Customer name: _____	
	Shipping address: _____	
	Place/date: _____	Stamp and signature _____



# Notes

---

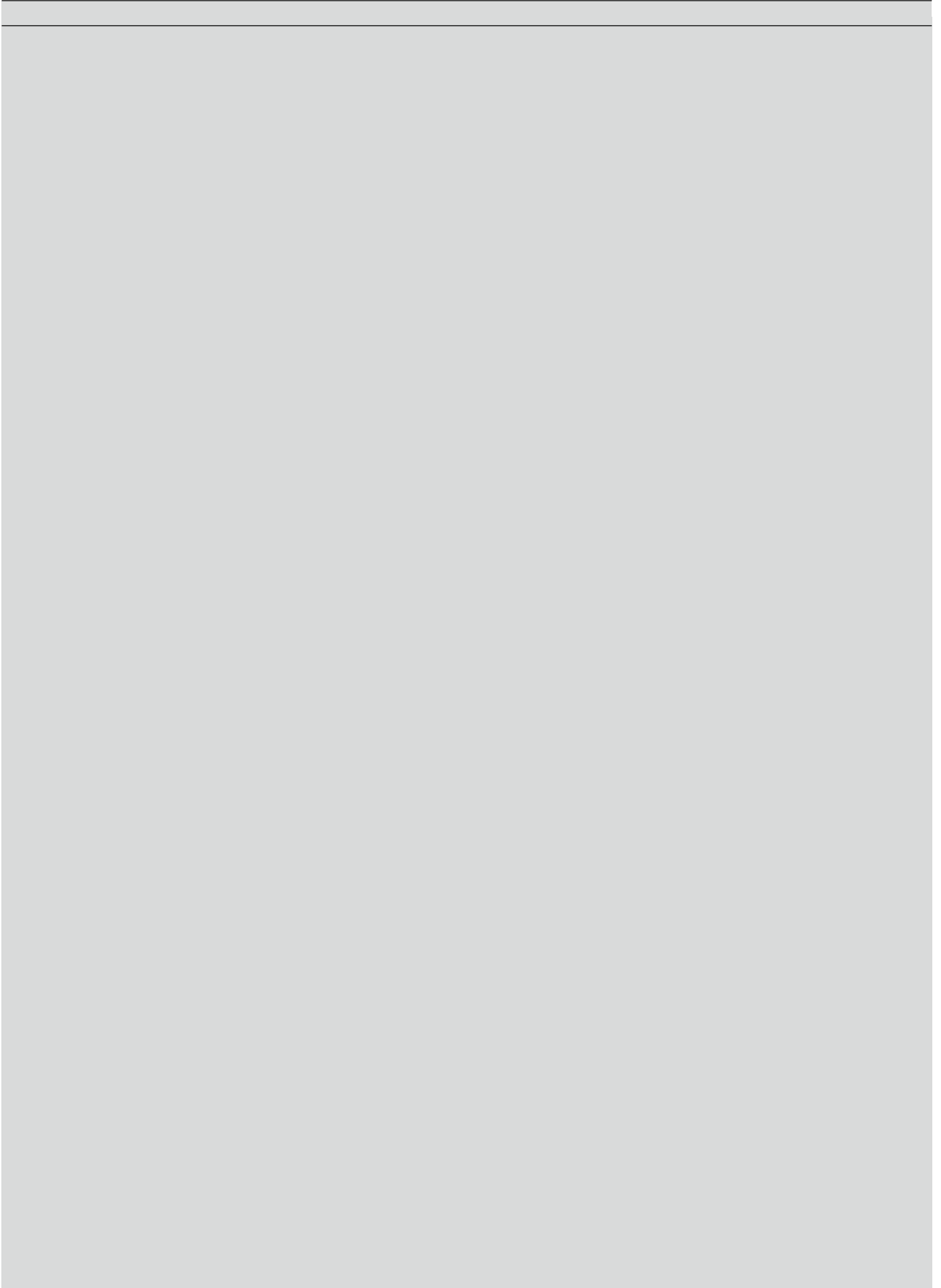



# General Terms and Conditions of Sale and Delivery (Issue 01.03.2016)

## § 1 General

1. Our General Terms and Conditions of Sale and Delivery apply to all deliveries and services in accordance with the contract concluded between us and the Customer.
2. Our General Terms and Conditions of Sale and Delivery are exclusively applicable; Customers' conditions which conflict with or deviate from our conditions are not recognised unless we have agreed to them expressly in writing.
3. Our General Terms and Conditions of Sale and Delivery apply only to transactions with business entities as per § 14 of the German Civil Code [BGB].

## § 2 Entry into Contract

1. Our offers are without engagement and non-binding, unless otherwise agreed. Decisive for nature and scope is our order confirmation. We reserve the right to make technical changes as well as changes in form, colour and/or weight insofar as is reasonable.
2. The offer shall be regarded as accepted only when an order confirmation is issued or the goods are dispatched. The issue of a confirmation of receipt or the receipt of a telephone order do not constitute a binding acceptance. In the case of goods that have to be made to order, following our written confirmation the contract shall be regarded as having been entered into even if details of its execution which may affect price and delivery remain to be clarified. The right to make design and form changes during the delivery period is reserved, provided that the subject of delivery and its function and appearance are not fundamentally altered thereby. There will be no resulting change in price.
3. In respect of figures, drawings, calculations and similar documents, we reserve ownership and copyright. This likewise applies to such documents designated as "confidential". These documents may not be made available to third parties without our express prior approval.

## § 3 Prices and Terms of Payment

1. Unless otherwise specified in the order confirmation, our prices apply "ex works", excluding transport and assembly, which shall be invoiced separately. Costs for packaging, with the exception of small and spare parts, are included. The value added tax as required by law is not included in our prices; this tax will be shown separately on the invoice at the legal rate applicable on the date of invoicing.
2. Our invoices shall be due to be paid net (without deduction) within 30 days. The deduction of discounts requires a special agreement in writing.
3. Should the price of materials increase taxes or levies be increased after the contract has been concluded, we shall be entitled to adjust our prices accordingly if there are at least 4 months between entry into contract and intended delivery.
4. Should the Customer commission not only delivery but also assembly or similar services, these shall be invoiced by the hour unless a fixed rate has been agreed expressly. Our valid Terms and Conditions of Installation shall apply to all assembly services.
5. We are entitled, even in the case of conflicting Customer conditions, to set off payments against the Customer's previous debts. If costs and interest have already incurred, we are entitled to set off the payment against the costs, then to the interest and finally to the main service.
6. We are also entitled to make our remaining claims immediately payable and render the execution of all further services subject to an advance payment or provision of security, if we become aware of circumstances that call the solvency and the credit standing of the Customer into question, in particular in the event of default in payment. The right to claim further damages will remain unaffected.
7. During the delay, the Customer cannot invoke the right to possession. Any claim for return on our side during a delay on the Customers side shall only be considered as withdrawal from the contract if we have specified this expressly in writing.
8. The Customer shall only have the right to offsetting if the Customer's counterclaims have been determined without further legal recourse, beyond dispute or if the counterclaims have been recognised by us. The Customer can only exert a right of retention if and when the counterclaim rests on the same contractual relationship.

## § 4 Place of Fulfilment, Transfer of Risk

1. Unless otherwise specified in the order confirmation, a delivery "ex works" (INCOTERMS 2010) has been agreed. The risk of accidental loss or deterioration of the goods purchased passes to the Customer upon hand-over of the goods to the shipping agent, the freight forwarder or the person or establishment otherwise appointed to execute the shipment. This shall likewise apply in case of partial delivery or if we have taken over other services (e.g. shipping or assembly).
2. Should the Customer be in default of acceptance, the risk of accidental loss or deterioration of the goods purchased shall pass to the Customer. Any storage costs incurred shall comply with § 5 No. 3.
3. If carriage paid delivery of the goods has been agreed, the means of transport must be unloaded immediately by the Customer. Waiting times will always be at the Customer's expense. Direct delivery to site shall always be regarded as on truck on an even, drivable road. Unloading including transportation to the place of use or storage is the responsibility of the Customer who in the event of delay must bear the cost and risk of unloading, stacking, storage or return transport. The recipient acting on behalf of the Customer at the place of unloading shall be regarded as authorised to accept the load with binding effect.

## § 5 Period of Delivery

1. The period of delivery specified by us shall only begin after clarification of all technical questions.
2. Information on delivery dates shall be considered the expected periods of delivery and are always subject to correct and timely delivery by suppliers and/or other manufacturers to us. The Customer may only set a time limit for the supply/performance if the expected delivery date has been exceeded by more than three weeks. This time limit must be reasonable and must amount to a minimum of three weeks. Claims for damages due to non-compliance with an expected delivery date are excluded. Delays in supply and performance as a result of force majeure or as a result of events which materially impede or prevent us from making delivery – including in particular subsequent material sourcing difficulties for which we are not responsible, interruption of operations, strikes, lockouts, official directives, etc., even if these affect our suppliers or sub-suppliers – will be notified to the Customer immediately. Events of this type entitle us to withdraw from the contract either in whole or in part if the order is not yet completed. In the event of withdrawal, any compensating measures already performed by the Customer shall be reimbursed immediately.
3. Should the Customer be in delay of acceptance, we are entitled to store the goods at the Customer's risk and expense. For the corresponding storage costs, we can optionally demand reimbursement of the actually incurred costs or of a fixed rate of 5% of the invoice sum for each commenced month. This also applies to storage by us. The Customer has the right to prove less damage in the event of a claim to flat-rate damage reimbursement.
4. Should, after the time limit set by us has expired, the Customer refuse to accept the goods or declare to no longer want to accept the goods without entitlement to do so, we can also demand damage compensation due to non-fulfilment.
5. Partial deliveries are permissible to a reasonable extent.

## § 6 Reservation of Title

1. We reserve ownership of the goods until complete payment of all claims from the ongoing business relationship with the Customer. Should the value of the reserved goods exceed the claims to be secured from the ongoing business relationship with the Customer by more than 20%, we are obligated to release the reserved goods on Customer request. The selection of the securities to be released is at our discretion.
2. Where retention of title is in effect, the Customer is obligated to treat the goods purchased with care and sufficiently insure them against fire, water and theft at their value when new and at the Customer's expense. Any claims asserted for damages by the Customer against the insurer or other third parties due to deterioration of the reserved goods are right now signed over to us at the amount of the invoice sum. Should maintenance and inspection work be required, the Customer shall perform said work regularly at the Customer's own expense. The Customer must inform us immediately and in writing of all access of third parties to the goods, in particular of all foreclosure and any damage to or destruction of the goods. The Customer must inform us of a change in possession of the goods as well as a change in the Customer's address immediately. The Customer must reimburse us of all damage and costs caused by a violation of this obligation and resulting necessary intervention measures to prevent access of third parties to the goods. In the event of access by third parties, the Customer must also provide us with the necessary help to exercise our rights.
3. The Customer is not permitted to pledge reserved goods nor assign them as security.
4. Processing or transformation of goods supplied subject to the reservation of title is always undertaken by the Customer on our behalf. Should the reserved goods be combined or processed with other items, the reservation of title shall continue for the processed or combined goods. If the reserved goods are processed or combined inextricably with items which are not our property, we shall acquire ownership of the new object in the ratio of the invoice value of the reserved goods to the invoice value of the other goods used at the time of processing or combination. The resulting co-ownership rights shall be deemed to be reserved goods in accordance with these terms and conditions. If our goods are joined or combined inextricably with other movable items into a single object and the other object is to be considered the main object, the Customer shall concede proportionate joint ownership to us should the main object belong to the Customer. In the aforementioned cases, the Customer here and now assigns all ownership rights to the processed, joined, or combined goods to us. Instead of a transfer, the Customer shall hold the processed, joined, or combined object in safe custody on our behalf. For the object resulting from processing, use, or combination, the same applies in all other respects as for reserved goods.
5. The Customer is entitled to resell goods supplied subject to reservation of title by way of due and proper business transactions. The Customer here and now assigns all claims with all rights arising from the resale of the reserved goods to us in full. We accept this assignment. Should the Customer sell the reserved goods – after processing/combination – together with goods not belonging to the Customer, the Customer here and now assigns to us the claims resulting from resale at the value at new of the reserved goods along with all ancillary rights. We accept this assignment right now. The Customer is entitled to collect this claim even after assignment. However, we reserve the right to collect the claim ourselves as soon as the Customer fails to properly meet payment obligations and enters into default, or reasonable doubt about the Customer's solvency and credit standing exists. On our request, the amount of the assigned claim, the person of the debtor and all other information required for collection must be provided, the corresponding documents be handed over and the debtor be notified of the assignment.
6. The right to further processing and resale ends with withdrawal from the contract.
7. During the Customer's standard business hours, we are at all times entitled to enter the offices and operating premises to check the reserved goods and to take possession of the reserved goods insofar as the Customer is unable to invoke rights to possession.

## § 7 Defect Claims

1. The Customer shall be entitled to claims for defect only if the Customer's duties to inspect and report pursuant to § 377 of the German Commercial Code [HGB] have been duly complied with. In the event that complaints are not reported in due time and/or in due form, the goods shall be regarded as accepted.
2. For the delivery of objects, we are free to decide to affect supplementary performance either by repair or replacement. If supplementary performance fails, the Customer can at his choice demand a reduction, withdrawal or compensation. In the event of only minor defects the Customer has no right to withdrawal.
3. As a matter of principle, the nature of the goods purchased shall be defined solely by the manufacturer's product description/order confirmation. Public statements, recommendations or advertisements by the manufacturer do not constitute contractual statements as to the nature of the goods.
4. The period of limitation for defect claims is based on § 438, Para. 1, No. 2 of the German Civil Code [BGB] as long as no deviating time limits have been expressly agreed.
5. The Customer is not entitled to assign claims for material defects.

## § 8 Liability

1. We accept liability within legal provisions, provided the Customer asserts claims for damages that are based on intent or gross negligence. In the event of minor negligence, our liability is limited to predictable, typically occurring damage. We are not liable in the event of minor negligence of non-essential contractual obligations whose violation does not threaten the performance of the contract. This also applies to breach of duty by our legal representatives or vicarious agents.
2. Liability for negligent injury to life or limb or the impairment of a person's health remains unaffected from the above limitations of liability; this also applies to Customer claims according to the German Product Liability Act [Produkthaftungsgesetz].

## § 9 Concluding Provisions

1. The law of the Federal Republic of Germany shall apply. The UN Convention on the International Sale of Goods shall not be applicable.
2. To take legal effect, subsidiary agreements and amendments must be confirmed in writing. This likewise applies to any modification of the clause stipulating the written form.
3. Unless otherwise specified in the order confirmation, our headquarters are the place of fulfilment. The exclusive place of jurisdiction for all disputes arising from this contract shall be Bielefeld, Germany.
4. Insofar as individual terms of the contract including these General Terms and Conditions should be or become ineffective either in whole or in part, this shall not affect the validity of the remaining provisions.

# Hörmann: Quality without Compromise



Hörmann KG Amshausen, Germany



Hörmann KG Antriebstechnik, Germany



Hörmann KG Brandis, Germany



Hörmann KG Brockhagen, Germany



Hörmann KG Dissen, Germany



Hörmann KG Eckelhausen, Germany



Hörmann KG Freisen, Germany



Hörmann KG Ichttershausen, Germany



Hörmann KG Werne, Germany



Hörmann Alkmaar B.V., Netherlands



Hörmann Legnica Sp. z o.o., Poland



Hörmann Beijing, China



Hörmann Tianjin, China

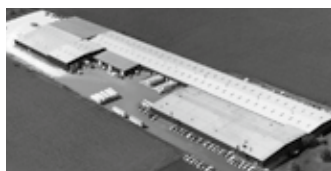

Hörmann LLC, Montgomery IL, USA



Hörmann Flexon LLC, Burgettstown PA, USA



Shakti Hörmann Pvt. Ltd., India

Hörmann is the only manufacturer worldwide that offers you a complete range of all major building products from one source. We manufacture in highly-specialised factories using the latest production technologies. The close-meshed network of sales and service companies throughout Europe, and activities in the USA and Asia, make Hörmann your strong partner for first-class building products, offering "Quality without Compromise".

**GARAGE DOORS**  
**OPERATORS**  
**INDUSTRIAL DOORS**  
**LOADING EQUIPMENT**  
**HINGED DOORS**  
**DOOR FRAMES**

**HÖRMANN**