

Side Sliding Sectional Door (HST 42)

Spare Parts Overview
Valid from 01.03.2017

HÖRMANN

Hörmann Subsidiaries and Affiliates



**Hörmann KG
Verkaufsgesellschaft**
Upheider Weg 94-98
D-33803 Steinhagen
Telefon +49 5204 915-0
Telefax +49 5204 915-277
Internet www.hoermann.com

Hörmann international sales organizations

International sales partners

Hörmann international sales organizations

Hörmann Austria
A-5310 Mondsee
info@hoermann.at

Hörmann Danmark
DK-8920 Randers
info@hoermann.dk

Hörmann Hrvatska
HR-10000 Zagreb
info@hoermann.hr

Hörmann Malaysia
MAL-40150 Shah Alam,
Selangor
sales@hoermann.com.my

Hörmann Portugal
P-2710-297 Sintra
info@hoermann.pt

Hörmann Türkiye
TR-Istanbul 34788
Tasdelen-Ümraniye
info.ist@hoermann.com.tr

Hörmann Baltic
LT-14247 Vilnius r.
info@hoermann.lt

Hörmann Eesti
EST-76505 Saue
in:info.tll@hoermann.ee

Hörmann Hungária
H-2310 Szigetszentmiklós
info@hoermann.hu

Hörmann Maroc
MA-28810 Mohammedia
info@hoermann.ma

Hörmann Romania
RO-077040, Chiajna,
Județul Ilfov
info@hoermann.ro

Hörmann UK
GB-Leicestershire
LE67 4JW
info@hoermann.co.uk

Hörmann Belarus
BY-220125 Minsk
s.kobrynets.min@hoermann.by

Hörmann España
E-08228 Terrassa
info.cat@hoermann.es

Hörmann India
IND-Andhra Pradesh-500 015
info@shaktihoermann.com

Hörmann Mexico
MEX-66350
Santa Catarina
info@hoermann.com.mx

Hörmann Russia
RUS-196626
Sankt Petersburg
info@hoermann.ru

Hörmann Ukraine
UA-08300 Boryspil,
Kyivska Obl.
info@hoermann.com.ua

Hörmann Belgium
B-3700 Tongeren
info@hoermann.be

Hörmann Finland
FIN-02420 Jorvas
info@mesvac.fi

Hörmann Italia
I-38015 Lavis (Trento)
info@hoermann.it

Hörmann Middle East & Africa
UAE-Dubai
info.dxb@hoermann.com

Hörmann Schweiz
CH-4702 Oensingen
info@hoermann.ch

Hörmann Vietnam
VN-Bac Ninh Province
info.han@hoermann.vn

Hörmann Brasil
BR-05305 002 São Paulo SP
info.sao@hoermann.com.br

Hörmann Flexon
USA-Burgettstown,
PA 15021
info@hoermann-flexon.com

Hörmann Japan
JP-103-0 002 Tokyo
t.takasu.tok@hoermann.jp

Hörmann Nederland
NL-3771 MB Barneveld
info@hoermann.nl

Hörmann Serbia
SRB-11271 Beograd-Surčin
info@hoermann.rs

Hörmann Bulgaria
BG-1532 Sofia
info.sof@hoermann.bg

Hörmann France
F-89107 Sens
info@hoermann.fr

Hörmann Kazakhstan
KZ-050004 Almaty
info@hoermann.kz

Hörmann Norge
N-4640 Søgne
info@hoermann.no

Hörmann Slovenská republika
SK-903 01 Senec
info.bts@hoermann.com

Hörmann Česká republika
CZ-252 68 Středokluky
info@hoermann.cz

Hörmann Hellas
GR-19400 Koropi
info@hoermann.gr

Hörmann Korea
KR-Kyunggi-do 463-400
info@hoermann.co.kr

Hörmann Polska
PL-62-052 Komorniki
info@hoermann.pl

Hörmann Svenska
S-70369 Örebro
info@hoermann.se

Hörmann China
CN-100176 Beijing
info@hoermann.cn

Hörmann Hong Kong
HK-25 Westlands Road,
Quarry Bay
info@hoermann.com.hk

Hörmann LLC
USA-60538 Montgomery,
Illinois
info@hoermann.us

You can find more details on our foreign subsidiaries and respective regional sales offices at www.hoermann.com

International sales partners

Ägypten
Albanien
Algerien
Argentinien
Armenien
Aserbaidschan

Australien
Bangladesch
Bosnien-Herzegowina
Chile
Finnland
Georgien

Indonesien
Irland
Island
Israel
Kolumbien
Kosovo

Luxemburg
Malta
Mazedonien
Moldawien
Mongolei
Montenegro

Neuseeland
Peru
Philippinen
Slowenien
Taiwan
Thailand



Tunesien
Turkmenistan
Uruguay
Usbekistan
Venezuela

Prices in €. Copyright. No part of this price list may be reproduced without our permission. All details subject to change.

Table of Contents

■ Overview side sliding sectional door (HST 42)	4
■ Overview of S-curve fitting	5
■ Overview of manufactured door models	6
■ 1. Door Sections	8
■ 2. Accessories for door sections	16
■ 3. Fitting Parts for Door Sections	20
■ 4. Fitting parts for frames	27
■ 5. Operator Accessories	35
■ 6. Surcharges	36
■ Spare parts order form	40
■ Terms and Conditions of Supply and Installation (issue 1.3.2016)	41







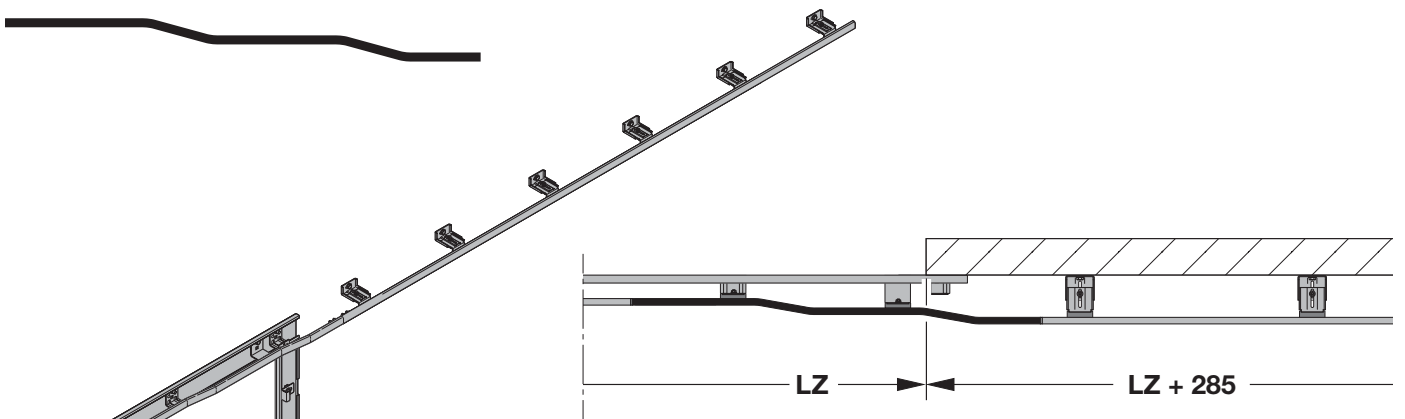
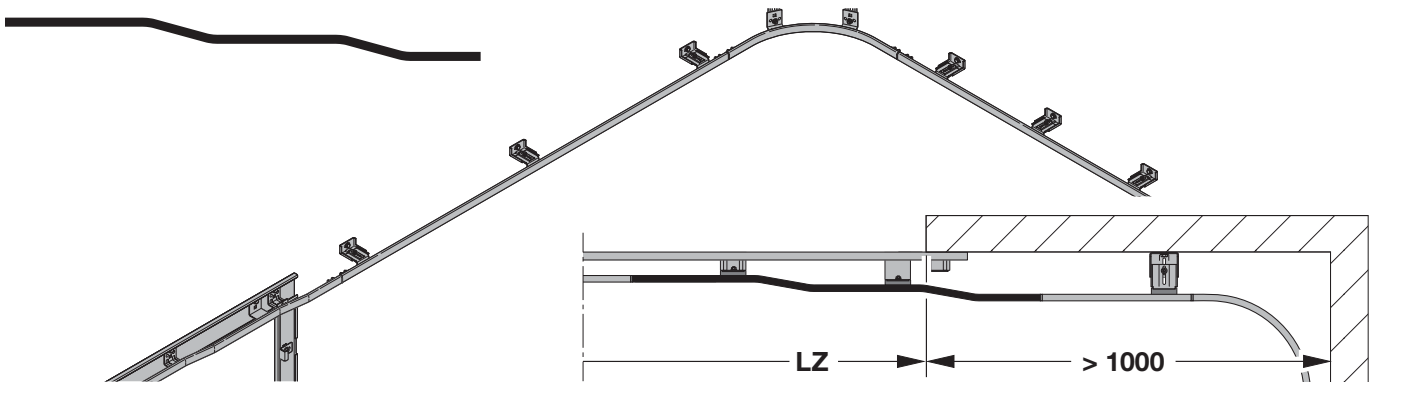
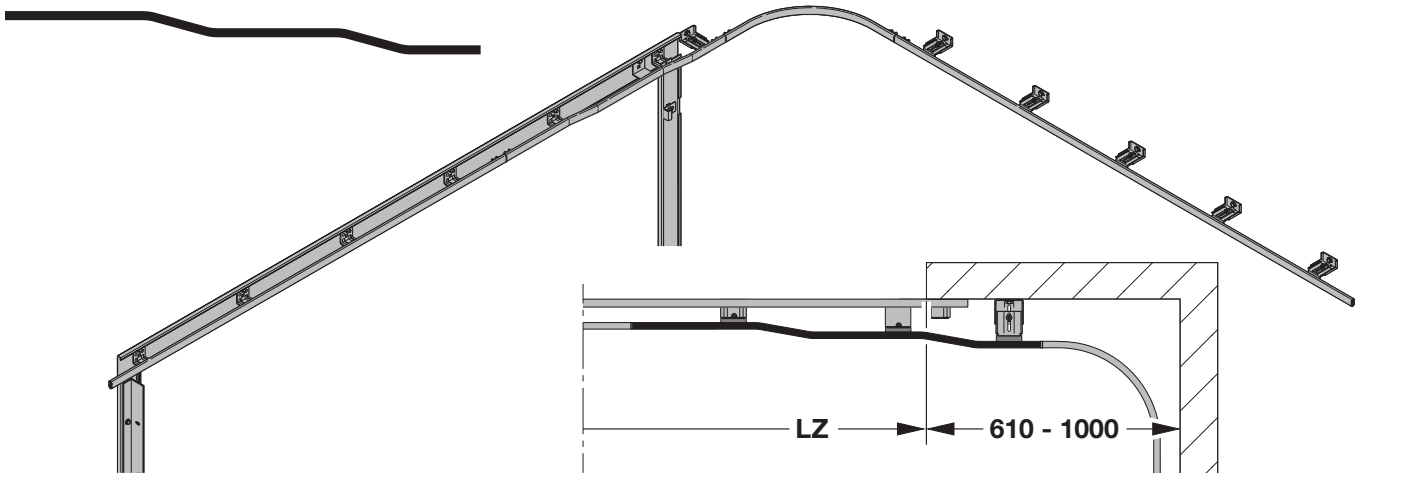
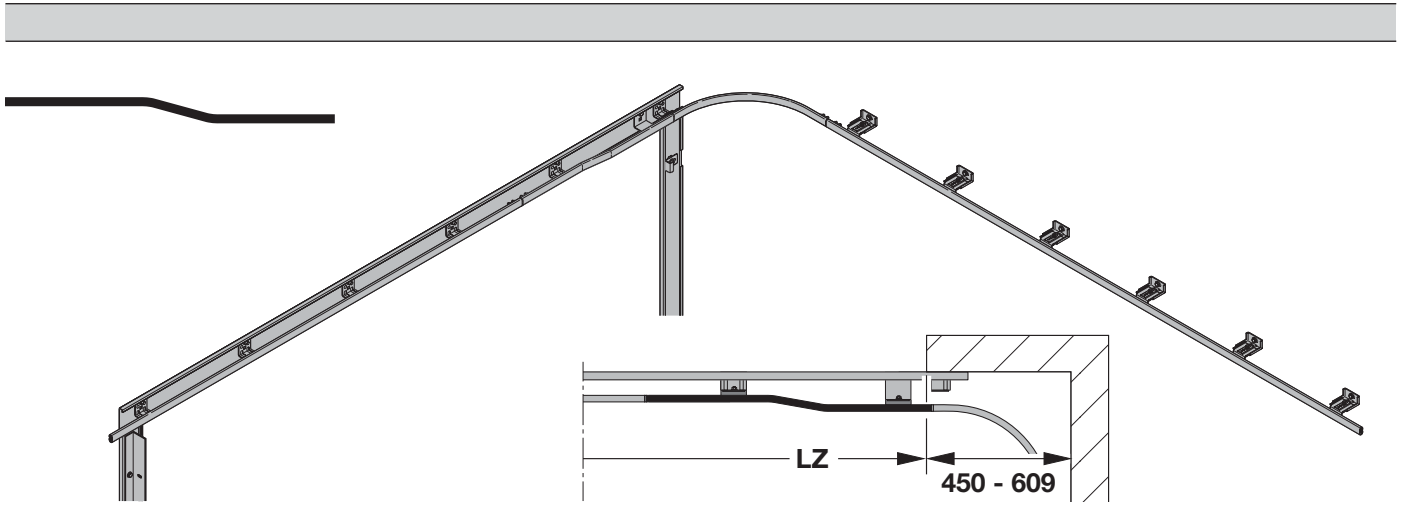



Symbols used

Symbol	Description
	Price on request
	Please note the extended delivery times.
•	Prices marked with a dot indicate articles that are available from stock and available immediately ex works.
	Article has been replaced.
op. r / cl. l	Opens to the right / closes to the left
op. l / cl. r	Opens to the left / closes to the right



Overview of S-curve fitting



Overview of manufactured door models

Tortyp	Erkennungsmerkmale	Produktionszeitraum
LPU 42 	Double-skinned, 42 mm M-ribbed, Woodgrain-dessiniert Polyester-primer coated based on RAL 9016 or colour or RAL to choose Door section height (mm): 468, 475, 479 488 500 520 525 531 550 562 Spacing (mm): 234, 237, 239 244 250 260 262 265 275 281	01.07.2012 –
LPU 42 	Double-skinned, 42 mm M-ribbed, Silkgrain Polyester-primer coated based on RAL 9016 or colour or RAL to choose Door section height (mm): 468, 475, 488, 500, 520, 531, 550, 562 Sickenabstand (mm): 234, 237, 244, 250, 260, 265, 275, 281	01.07.2012 –
LPU 42 	Double-skinned, 42 mm M-ribbed, New Silkgrain Polyester-primer coated based on RAL 9016 or colour Door section height (mm): 468, 475, 488, 500, 520, 531, 550, 562 Sickenabstand (mm): 234, 237, 244, 250, 260, 265, 275, 281	01.03.2013 – 30.06.2014
LPU 42 	Double-skinned, 42 mm M-ribbed, Sandgrain Polyester-primer coated based on RAL 9016, 7016, 8028, 9006 Door section height (mm): 468, 475, 488, 500, 520, 531, 550, 562 Spacing (mm): 234, 237, 244, 250, 260, 265, 275, 281	01.07.2014 –
LPU 42 	Double-skinned, 42 mm M-ribbed, Decograin Coated with a plastic film with timber designs Golden Oak, Dark Oak, Titan Metallic CH703 Door section height (mm): 468, 475, 488, 500, 520, 531, 550, 562 Spacing (mm): 234, 237, 244, 250, 260, 265, 275, 281	01.07.2012 –
LPU 42 	Double-skinned, 42 mm L-ribbed, Woodgrain-dessiniert Polyester-primer coated based on RAL 9016 or Color or RAL to choose Door section height (mm): 468, 475, 479 488 500 520 525 531 550 562	01.03.2013 – 30.06.2014
LPU 42 	Double-skinned, 42 mm L-ribbed, Silkgrain Polyester-primer coated based on RAL 9016 or colour or RAL to choose Door section height (mm): 468, 475, 488, 500, 520, 531, 550, 562	01.07.2012 –
LPU 42 	Double-skinned, 42 mm L-ribbed, New Silkgrain Polyester-primer coated based on RAL 9016 or colour Door section height (mm): 468, 475, 488, 500, 520, 531, 550, 562	01.03.2013 – 30.06.2014
LPU 42 	Double-skinned, 42 mm L-ribbed, Sandgrain Polyester-primer coated based on RAL 9016, 7016, 8028, 9006 Door section height (mm): 468, 475, 488, 500, 520, 531, 550, 562	01.07.2014 –
LPU 42 	Double-skinned, 42 mm L-ribbed, Decograin Coated with a plastic film with timber designs Golden Oak, Dark Oak, Titan Metallic CH703 Door section height (mm): 468, 475, 488, 500, 520, 531, 550, 562	01.07.2012 –

Overview of manufactured door models

Tortyp	Erkennungsmerkmale	Produktionszeitraum
LPU 42 	Double-skinned, 42 mm S-panelled, Woodgrain-textured Polyester-primer coated based on RAL 9016 or Color or RAL to choose Door section height (mm): 468, 475, 479 488 500 520 525 531 550 562	01.07.2012 –
LPU 42 	Double-skinned, 42 mm S-panelled, Decograin Coated with a plastic film with timber designs Golden Oak, Dark Oak Door section height (mm): 468, 475, 479 488 500 520 525 531 550 562	01.07.2012 –

1. Door Sections

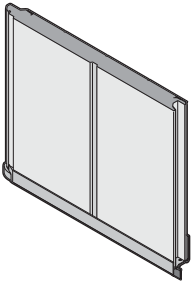
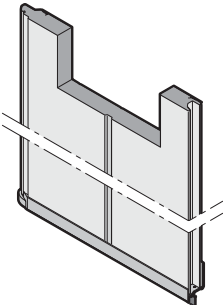
Article	Pos.	Description	Production period	Art. no.	Quantity	€
	*	1.1 HST door section, closing side, M-ribbed			Unit(s)	
		Woodgrain	01.07.2012 –	4004880	_____	/m ²
		Silkgrain	01.07.2012 –	4004887	_____	/m ²
		New Silkgrain	01.03.2013 – 01.07.2014	4004890	_____	/m ²
		Decograin	01.07.2012 –	4004894	_____	/m ²
		Sandgrain	01.07.2014 –	4011483	_____	/m ²
		Based on RAL _____			_____	+ ¹
		Decograin design version			_____	+ ²
		Surcharge for lock cut-out		4006075	_____	[+]
		Surcharge per ventilation grille		3041072	_____	/ each
	Ventilation grille based on RAL _____		_____	_____	+ ⁶	
	*	1.2 HST door section, closing side, M-ribbed, with glazing			Unit(s)	
		Woodgrain	01.07.2012 –	4008691	_____	/m ²
		Silkgrain	01.07.2012 –	4008692	_____	/m ²
		New Silkgrain	01.03.2013 – 01.07.2014	4008693	_____	/m ²
		Decograin	01.07.2012 –	4008694	_____	/m ²
		Sandgrain	01.07.2014 –	4011484	_____	/m ²
		Based on RAL _____			_____	+ ¹
		Decograin design version			_____	+ ²
		Surcharge for lock cut-out		4006075	_____	[+]
		Surcharge per ventilation grille		3041072	_____	/ each
	Ventilation grille based on RAL _____		_____	_____	+ ⁶	
	Glazing		_____	_____	+ ³	
	Glazing based on RAL _____		_____	_____	+ ⁴	

+¹ Surcharges for polyester primer coating in Color or RAL to choose, see page 36 / indicate colour article number.

+² Surcharges for Decograin / Decopaint, see page 36 / indicate article number of the respective Decograin / Decopaint

+³ Surcharges for glazing (window frame incl. infill), see page 38 / indicate article number of the respective glazing.

+⁴ Surcharges for painted window frames in Color, RAL to choose or matching Decograin, see page 37 / indicate colour article number.

+⁵ Surcharges for design elements, see page 38 / indicate article number of the respective design.

+⁶ Surcharges for painted ventilation grilles in Color, RAL to choose or matching Decograin, see page 37 / indicate colour article number.

[+] No surcharge

ORDER	Customer no.: _____	Order no. / com.: _____	*Please take information from the data label!	
	Customer name: _____	Shipping address: _____	Order no.:	Year of manufacture:
	Place / date: _____	Stamp and signature _____	Serial no.:	Size:

1. Door Sections

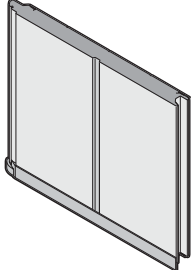
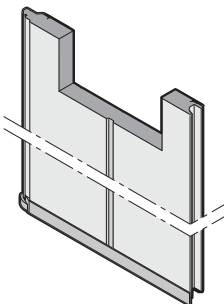
Article	Pos.	Description	Production period	Art. no.	Quantity	€
	*	1.3 Intermediate door section HST, M-ribbed			Unit(s)	
		Woodgrain	01.07.2012 –	4004881	_____	/m ²
		Silkgrain	01.07.2012 –	4004888	_____	/m ²
		New Silkgrain	01.03.2013 – 01.07.2014	4004893	_____	/m ²
		Decograin	01.07.2012 –	4004895	_____	/m ²
		Sandgrain	01.07.2014 –	4011487	_____	/m ²
		Based on RAL _____			_____	+1
		Decograin design version			_____	+2
		Surcharge per ventilation grille		3041072	_____	/ each
	Ventilation grille based on RAL _____		_____	_____	+6	
	*	1.4 Intermediate door section HST, M-Sicke, with glazing			Unit(s)	
		Woodgrain	01.07.2012 –	4004882	_____	/m ²
		Silkgrain	01.07.2012 –	4004889	_____	/m ²
		New Silkgrain	01.03.2013 – 01.07.2014	4004897	_____	/m ²
		Decograin	01.07.2012 –	4004896	_____	/m ²
		Sandgrain	01.07.2014 –	4011488	_____	/m ²
		angelehnt RAL _____			_____	+1
		Decograin design version			_____	+2
		Surcharge per ventilation grille		3041072	_____	/ each
	Ventilation grille based on RAL _____		_____	_____	+6	
	Glazing		_____	_____	+3	
	Glazing based on RAL _____		_____	_____	+4	

+1 Surcharges for polyester primer coating in Color or RAL to choose, see page 36 / indicate colour article number.

+2 Surcharges for Decograin / Decopaint, see page 36 / indicate article number of the respective Decograin / Decopaint

+3 Surcharges for glazing (window frame incl. infill), see page 38 / indicate article number of the respective glazing.

+4 Surcharges for painted window frames in Color, RAL to choose or matching Decograin, see page 37 / indicate colour article number.

+5 Surcharges for design elements, see page 38 / indicate article number of the respective design.

+6 Surcharges for painted ventilation grilles in Color, RAL to choose or matching Decograin, see page 37 / indicate colour article number.

[+] No surcharge

ORDER	Customer no.:	Order no. / com.:	*Please take information from the data label!	
			Order no.:	Year of manufacture:
	Customer name:		Serial no.:	Size:
	Shipping address:			
	Place / date:	Stamp and signature		

1. Door Sections

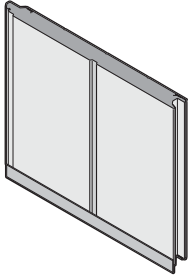
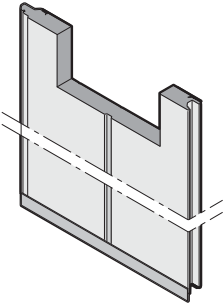
Article	Pos.	Description	Production period	Art. no.	Quantity	€
	*	1.5 HST door section, curve side, M-ribbed			Unit(s)	
		Woodgrain	01.07.2012 –	4004884	_____	/m ²
		Silkgrain	01.07.2012 –	4004891	_____	/m ²
		New Silkgrain	01.03.2013 – 01.07.2014	4004900	_____	/m ²
		Decograin	01.07.2012 –	4004898	_____	/m ²
		Sandgrain	01.07.2014 –	4011479	_____	/m ²
		Based on RAL _____			_____	+ ¹
		Decograin design version			_____	+ ²
		Surcharge per ventilation grille		3041072	_____	/ each
	Ventilation grille based on RAL _____		_____	_____	+ ⁶	
	*	1.6 HST door section, curve side, M-ribbed, with glazing			Unit(s)	
		Woodgrain	01.07.2012 –	4004885	_____	/m ²
		Silkgrain	01.07.2012 –	4004892	_____	/m ²
		New Silkgrain	01.03.2013 – 01.07.2014	4004904	_____	/m ²
		Decograin	01.03.2013 –	4004899	_____	/m ²
		Sandgrain	01.07.2014 –	4011480	_____	/m ²
		Based on RAL _____			_____	+ ¹
		Decograin design version			_____	+ ²
		Surcharge per ventilation grille		3041072	_____	/ each
	Ventilation grille based on RAL _____		_____	_____	+ ⁶	
	Glazing		_____	_____	+ ³	
	Glazing based on RAL _____		_____	_____	+ ⁴	

+¹ Surcharges for polyester primer coating in Color or RAL to choose, see page 36 / indicate colour article number.

+² Surcharges for Decograin / Decopaint, see page 36 / indicate article number of the respective Decograin / Decopaint

+³ Surcharges for glazing (window frame incl. infill), see page 38 / indicate article number of the respective glazing.

+⁴ Surcharges for painted window frames in Color, RAL to choose or matching Decograin, see page 37 / indicate colour article number.

+⁵ Surcharges for design elements, see page 38 / indicate article number of the respective design.

+⁶ Surcharges for painted ventilation grilles in Color, RAL to choose or matching Decograin, see page 37 / indicate colour article number.

[+] No surcharge

ORDER	Customer no.: _____	Order no. / com.: _____	*Please take information from the data label!	
	Customer name: _____	Shipping address: _____	Order no.:	Year of manufacture:
	Place / date: _____	Stamp and signature _____	Serial no.:	Size:

1. Door Sections

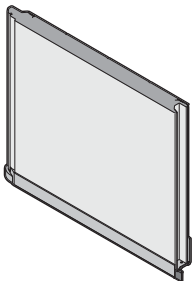
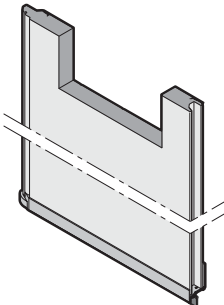
Article	Pos.	Description	Production period	Art. no.	Quantity	€
	*	1.7 HST door section, closing side, L-ribbed			Unit(s)	
		Woodgrain	01.07.2012 – 01.07.2014	4004901	_____	/m ²
		Silkgrain	01.07.2012 –	4004908	_____	/m ²
		New Silkgrain	01.03.2013 – 01.07.2014	4004907	_____	/m ²
		Decograin	01.07.2014 –	4011492	_____	/m ²
		Sandgrain	01.07.2014 –	4011481	_____	/m ²
		Based on RAL _____			_____	+1
		Decograin design version			_____	+2
		Surcharge for lock cut-out		4006075	_____	[+]
		Surcharge per ventilation grille		3041072	_____	/ each
	Ventilation grille based on RAL _____			_____	+6	
	Style			_____	+5	
	*	1.8 HST door section, closing side, L-ribbed, with glazing			Unit(s)	
		Woodgrain	01.07.2012 – 01.07.2014	4008695	_____	/m ²
		Silkgrain	01.07.2012 –	4008696	_____	/m ²
		New Silkgrain	01.03.2013 – 01.07.2014	4008697	_____	/m ²
		Decograin	01.07.2014 –	4011493	_____	/m ²
		Sandgrain	01.07.2014 –	4011482	_____	/m ²
		Based on RAL _____			_____	+1
		Decograin design version			_____	+2
		Surcharge for lock cut-out		4006075	_____	[+]
		Surcharge per ventilation grille		3041072	_____	/ each
	Ventilation grille based on RAL _____			_____	+6	
	Glazing			_____	+3	
	Glazing based on RAL _____			_____	+4	

+1 Surcharges for polyester primer coating in Color or RAL to choose, see page 36 / indicate colour article number.

+2 Surcharges for Decograin / Decopaint, see page 36 / indicate article number of the respective Decograin / Decopaint

+3 Surcharges for glazing (window frame incl. infill), see page 38 / indicate article number of the respective glazing.

+4 Surcharges for painted window frames in Color, RAL to choose or matching Decograin, see page 37 / indicate colour article number.

+5 Surcharges for design elements, see page 38 / indicate article number of the respective design.

+6 Surcharges for painted ventilation grilles in Color, RAL to choose or matching Decograin, see page 37 / indicate colour article number.

[+] No surcharge

ORDER	Customer no.: _____	Order no. / com.: _____	*Please take information from the data label!	
			Order no.: _____	Year of manufacture: _____
	Customer name: _____		Serial no.: _____	Size: _____
	Shipping address: _____			
	Place / date: _____		Stamp and signature _____	

1. Door Sections

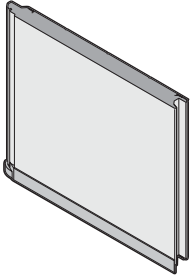
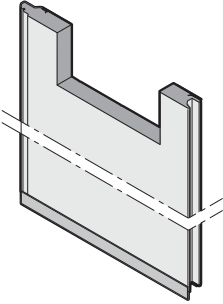
Article	Pos.	Description	Production period	Art. no.	Quantity	€
	*	1.9 HST door section, intermediate, L-ribbed			Unit(s)	
		Woodgrain	01.07.2012 – 01.07.2014	4004902	_____	/m ²
		Silkgrain	01.07.2012 –	4004909	_____	/m ²
		New Silkgrain	01.03.2013 – 01.07.2014	4004911	_____	/m ²
		Decograin	01.07.2014 –	4011494	_____	/m ²
		Sandgrain	01.07.2014 –	4011485	_____	/m ²
		Based on RAL _____			_____	+ ¹
		Decograin design version			_____	+ ²
		Surcharge per ventilation grille		3041072	_____	/ each
		Ventilation grille based on RAL _____		_____	_____	+ ⁶
	Style		_____	_____	+ ⁵	
	*	1.10 HST door section, L-ribbed, with glazing			Unit(s)	
		Woodgrain	01.07.2012 – 01.07.2014	4004903	_____	/m ²
		Silkgrain	01.07.2012 –	4004910	_____	/m ²
		New Silkgrain	01.03.2013 – 01.07.2014	4004914	_____	/m ²
		Decograin	01.07.2014 –	4011495	_____	/m ²
		Sandgrain	01.07.2014 –	4011486	_____	/m ²
		Based on RAL _____			_____	+ ¹
		Decograin design version			_____	+ ²
		Surcharge per ventilation grille		3041072	_____	/ each
		Ventilation grille based on RAL _____		_____	_____	+ ⁶
	Glazing		_____	_____	+ ³	
	Glazing based on RAL _____		_____	_____	+ ⁴	

+¹ Surcharges for polyester primer coating in Color or RAL to choose, see page 36 / indicate colour article number.

+² Surcharges for Decograin / Decopaint, see page 36 / indicate article number of the respective Decograin / Decopaint

+³ Surcharges for glazing (window frame incl. infill), see page 38 / indicate article number of the respective glazing.

+⁴ Surcharges for painted window frames in Color, RAL to choose or matching Decograin, see page 37 / indicate colour article number.

+⁵ Surcharges for design elements, see page 38 / indicate article number of the respective design.

+⁶ Surcharges for painted ventilation grilles in Color, RAL to choose or matching Decograin, see page 37 / indicate colour article number.

[+] No surcharge

ORDER	Customer no.: _____	Order no. / com.: _____	*Please take information from the data label!	
	Customer name: _____	Shipping address: _____	Order no.:	Year of manufacture:
	Place / date: _____	Stamp and signature _____	Serial no.:	Size:

1. Door Sections

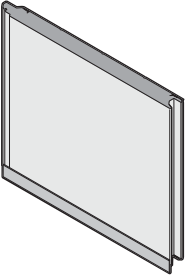
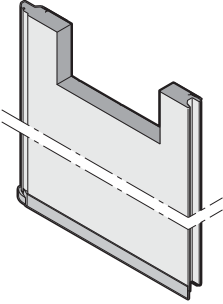
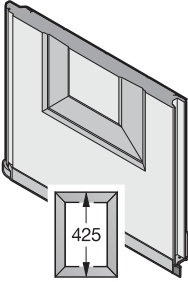
Article	Pos.	Description	Production period	Art. no.	Quantity	€
	*	1.11 HST door section, curve side, L-ribbed			Unit(s)	
		Woodgrain	01.07.2012 – 01.07.2014	4004905	_____	/m ²
		Silkgrain	01.07.2012 –	4004912	_____	/m ²
		New Silkgrain	01.03.2013 – 01.07.2014	4008689	_____	/m ²
		Decograin	01.07.2014 –	4011490	_____	/m ²
		Sandgrain	01.07.2014 –	4011477	_____	/m ²
		Based on RAL _____			_____	+1
		Decograin design version			_____	+2
		Surcharge per ventilation grille		3041072	_____	/ each
		Ventilation grille based on RAL _____			_____	+6
	Style			_____	+5	
	*	1.12 HST door section, curve side, L-ribbed, with glazing			Unit(s)	
		Woodgrain	01.07.2012 – 01.07.2014	4004906	_____	/m ²
		Silkgrain	01.07.2012 –	4004913	_____	/m ²
		New Silkgrain	01.03.2013 – 01.07.2014	4008690	_____	/m ²
		Decograin	01.07.2014 –	4011491	_____	/m ²
		Sandgrain	01.07.2014 –	4011478	_____	/m ²
		Based on RAL _____			_____	+1
		Decograin design version			_____	+2
		Surcharge per ventilation grille		3041072	_____	/ each
		Ventilation grille based on RAL _____			_____	+6
	Glazing			_____	+3	
	Glazing based on RAL _____			_____	+4	
	*	1.13 HST door section, closing side, S-panelled			Unit(s)	
		Woodgrain	01.07.2012 –	4004915	_____	/m ²
		Decograin	01.07.2012 –	4004920	_____	/m ²
		Based on RAL _____			_____	+1
		Decograin design version			_____	+2
	Surcharge for lock cut-out		4006075	_____	[+]	

+¹ Surcharges for polyester primer coating in Color or RAL to choose, see page 36 / indicate colour article number.

+² Surcharges for Decograin / Decopaint, see page 36 / indicate article number of the respective Decograin / Decopaint

+³ Surcharges for glazing (window frame incl. infill), see page 38 / indicate article number of the respective glazing.

+⁴ Surcharges for painted window frames in Color, RAL to choose or matching Decograin, see page 37 / indicate colour article number.

+⁵ Surcharges for design elements, see page 38 / indicate article number of the respective design.

+⁶ Surcharges for painted ventilation grilles in Color, RAL to choose or matching Decograin, see page 37 / indicate colour article number.

[+] No surcharge

ORDER	Customer no.: _____	Order no. / com.: _____	*Please take information from the data label!	
			Order no.: _____	Year of manufacture: _____
	Customer name: _____		Serial no.: _____	Size: _____
	Shipping address: _____			
	Place / date: _____		Stamp and signature _____	

1. Door Sections

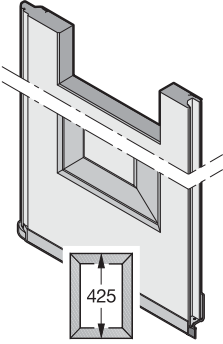
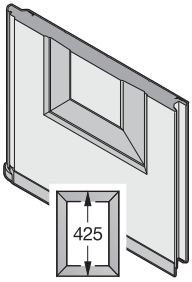
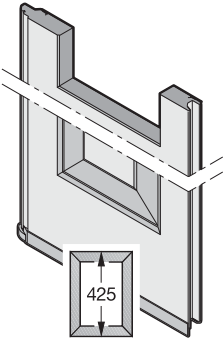
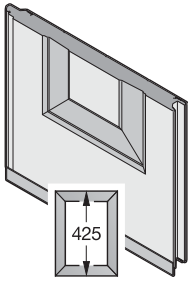
Article	Pos.	Description	Production period	Art. no.	Quantity	€																		
	*	1.14 HST door section, closing side, S-panelled, with glazing Woodgrain Decograin Based on RAL _____ Decograin design version Surcharge for lock cut-out Glazing Glazing based on RAL _____	01.07.2012 – 01.07.2012 –	4008698 4008699 4006075 _____ _____	Unit(s) _____ _____ _____ _____ _____	/m ² /m ² + ¹ + ² [+] + ³ + ⁴																		
								1.15 Intermediate door section HST, S-panelled Woodgrain Decograin Based on RAL _____ Decograin design version	01.07.2012 – 01.07.2012 –	4004916 4004921 _____ _____	Unit(s) _____ _____ _____ _____	/m ² /m ² + ¹ + ²												
														1.16 Intermediate door section HST, S-panelled, with glazing Woodgrain Decograin Based on RAL _____ Decograin design version Glazing Glazing based on RAL _____	01.07.2012 – 01.07.2012 –	4004917 4004922 _____ _____	Unit(s) _____ _____ _____ _____	/m ² /m ² + ¹ + ² + ³ + ⁴						
																				1.17 HST door section, curve side, S-panelled Woodgrain Decograin Based on RAL _____ Decograin design version	01.07.2012 – 01.07.2012 –	4004918 4004923 _____ _____	Unit(s) _____ _____ _____ _____	/m ² /m ² + ¹ + ²

- +¹ Surcharges for polyester primer coating in Color or RAL to choose, see page 36 / indicate colour article number.
- +² Surcharges for Decograin / Decopaint, see page 36 / indicate article number of the respective Decograin / Decopaint
- +³ Surcharges for glazing (window frame incl. infill), see page 38 / indicate article number of the respective glazing.
- +⁴ Surcharges for painted window frames in Color, RAL to choose or matching Decograin, see page 37 / indicate colour article number.
- +⁵ Surcharges for design elements, see page 38 / indicate article number of the respective design.
- +⁶ Surcharges for painted ventilation grilles in Color, RAL to choose or matching Decograin, see page 37 / indicate colour article number.
- [+] No surcharge

ORDER	Customer no.: _____	Order no. / com.: _____	*Please take information from the data label!
	Customer name: _____	Shipping address: _____	Order no.: _____ Year of manufacture: _____
	Place / date: _____	Stamp and signature _____	Serial no.: _____ Size: _____

1. Door Sections

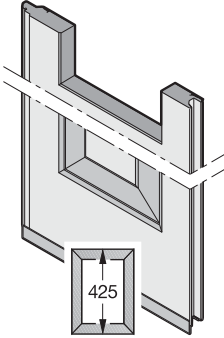
Article	Pos.	Description	Production period	Art. no.	Quantity	€
	*	1.18 HST door section, curve side, S-panelled, with glazing			Unit(s)	
		Woodgrain	01.07.2012 –	4004919	_____	/m ²
		Decograin	01.07.2012 –	4004924	_____	/m ²
		Based on RAL _____			_____	+1
		Decograin design version			_____	+2
	Glazing			_____	+3	
	Glazing based on RAL _____			_____	+4	

+¹ Surcharges for polyester primer coating in Color or RAL to choose, see page 36 / indicate colour article number.

+² Surcharges for Decograin / Decopaint, see page 36 / indicate article number of the respective Decograin / Decopaint

+³ Surcharges for glazing (window frame incl. infill), see page 38 / indicate article number of the respective glazing.

+⁴ Surcharges for painted window frames in Color, RAL to choose or matching Decograin, see page 37 / indicate colour article number.





+⁵ Surcharges for design elements, see page 38 / indicate article number of the respective design.

+⁶ Surcharges for painted ventilation grilles in Color, RAL to choose or matching Decograin, see page 37 / indicate colour article number.

[+] No surcharge

ORDER	Customer no.: _____	Order no. / com.: _____	*Please take information from the data label!	
			Order no.: _____	Year of manufacture: _____
	Customer name: _____		Serial no.: _____	Size: _____
	Shipping address: _____			
	Place / date: _____			
		Stamp and signature _____		







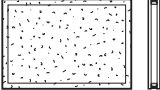

2. Accessories for door sections

Article	Pos.	Description	Production period	Art. no.	Quantity	€
	2.1	Panel glazing frame S0 (395 mm, standard design) for double-skinned door sections 42 mm Glazing based on RAL _____ Glazing	01.07.2012 –	4004972	Unit(s) _____	/each +4 +7
	2.2	Panel glazing frame S1 (395 mm, design no. 1) for double-skinned door sections 42 mm Glazing based on RAL _____ Glazing	01.07.2012 –	4004973	Unit(s) _____	/each +4 +7
	2.3	Panel glazing frame S2 (395 mm, design no. 2) for double-skinned door sections 42 mm Glazing based on RAL _____ Glazing	01.07.2012 –	4004974	Unit(s) _____	/each +4 +7
	2.4	Set: 10 tallow-drop screws for S glazing 3,5 x 40 mm LPU S-panelled 3,5 x 45 mm LPU ribbing	01.07.2012 – 01.07.2012 –	4002324 4012623	Unit(s) _____	/each /each
	2.5	Synthetic double pane for S-panel glazing (395 mm) Clear / clear Panelled doors (16 mm) Ribbed doors (22 mm)	01.07.2012 – 01.07.2012 –	3092748 3092758	Unit(s) _____	/each /each

- +4 Surcharges for painted window frames in Color, RAL to choose or matching Decograin, see page 37 / indicate colour article number.
+6 Surcharges for painted ventilation grilles in Color, RAL to choose or matching Decograin, see page 37 / indicate colour article number.
+7 Surcharge for window pane, see page 16 - 17 / indicate article number of the respective pane.
+8 Surcharges for window frame inlay, see page 18 / indicate article number of the respective inlay.
[+] No surcharge

ORDER	Customer no.:	Order no. / com.:	*Please take information from the data label!	
	Customer name:	Order no.:		Year of manufacture:
	Shipping address:	Serial no.:		Size:
	Place / date:	Stamp and signature		





2. Accessories for door sections

Article	Pos.	Description	Production period	Art. no.	Quantity	€
	2.6	Synthetic double pane for S-panel glazing (395 mm)			Unit(s)	
		Crystal structure / clear	01.07.2012 –	3092749	_____	/each
		Panelled doors (16 mm)	01.07.2012 –	3092759	_____	/each
		Ribbed doors (22 mm)				
		Crystal structure / crystal structure	01.07.2012 –	4014347	_____	/each
		Panelled doors (16 mm)	01.07.2012 –	4014352	_____	/each
		Ribbed doors (22 mm)				
	2.7	Design elements, style 451	01.07.2016 –	4009429	Unit(s) _____	/each
	2.8	Design elements, style 452	01.07.2016 –	4009430	Unit(s) _____	/each
	2.9	Design elements, style 454	01.07.2016 –	4009431	Unit(s) _____	/each
	2.10	Design elements, style 471	01.07.2016 –	4014245	Unit(s) _____	/each
	2.11	Design elements, style 459	001.07.2016 –	4009433	Unit(s) _____	/each
	2.12	Design elements, style 461			Unit(s)	
		Clear / clear	01.07.2016 –	4009434	_____	/each
		Crystal structure / crystal structure	01.07.2016 –	4014262	_____	/each
	2.13	Design elements, style 462			Unit(s)	
		Clear / clear	01.07.2016 –	4009436	_____	/each
		Crystal structure / crystal structure	01.07.2016 –	4014263	_____	/each

- +⁴ Surcharges for painted window frames in Color, RAL to choose or matching Decograin, see page 37 / indicate colour article number.
 +⁶ Surcharges for painted ventilation grilles in Color, RAL to choose or matching Decograin, see page 37 / indicate colour article number.
 +⁷ Surcharge for window pane, see page 16 - 17 / indicate article number of the respective pane.
 +⁸ Surcharges for window frame inlay, see page 18 / indicate article number of the respective inlay.
 [+] No surcharge

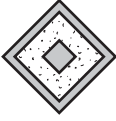
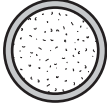
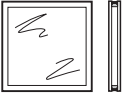
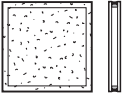
ORDER	Customer no.:	Order no. / com.:	*Please take information from the data label!	
			Order no.:	Year of manufacture:
	Customer name:		Serial no.:	Size:
	Shipping address:			
	Place / date:	Stamp and signature		

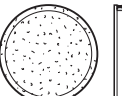
2. Accessories for door sections

Article	Pos. Description	Production period	Art. no.	Quantity	€
	2.14 Design elements, style 481			Unit(s)	
	Clear / clear Crystal structure / crystal structure	01.07.2016 – 01.07.2016 –	4014250 4014251	_____ _____	/ each / each
	2.15 Design elements, style 469			Unit(s)	
	Clear / clear Crystal structure / crystal structure	01.07.2016 – 01.07.2016 –	4009438 4014264	_____ _____	/ each / each
	2.16 Synthetic double pane for styles 461 – 463, clear / clear	01.07.2016 –	3089749	Unit(s) _____	/ each
	2.17 Synthetic double pane for styles 461 – 463, crystal structure / crystal structure	01.07.2016 –	4014345	Unit(s) _____	/ each
	2.18 Synthetic double pane for styles 69, clear / clear	01.07.2016 –	3089751	Unit(s) _____	/ each
	2.19 Synthetic double pane for styles 469, crystal structure / crystal structure	01.07.2016 –	4014346	Unit(s) _____	/ each
	2.20 Emblem holder 46 × 54,5 × 3,5 mm	01.07.2013 – 31.12.2016	3062273	Unit(s) _____	/ each
	2.21 Hörmann emblem 43 × 51,5 mm	01.07.2013 – 31.12.2016	3062274	Unit(s) _____	/ each

+4 Surcharges for painted window frames in Color, RAL to choose or matching Decograin, see page 37 / indicate colour article number.

+6 Surcharges for painted ventilation grilles in Color, RAL to choose or matching Decograin, see page 37 / indicate colour article number.



+7 Surcharge for window pane, see page 16 - 17 / indicate article number of the respective pane.

+8 Surcharges for window frame inlay, see page 18 / indicate article number of the respective inlay.

[+] No surcharge

ORDER	Customer no.:	Order no. / com.:	*Please take information from the data label!	
	Customer name:	Shipping address:	Order no.:	Year of manufacture:
	Shipping address:	Place / date:	Serial no.:	Size:
	Shipping address:			
	Shipping address:		Stamp and signature	

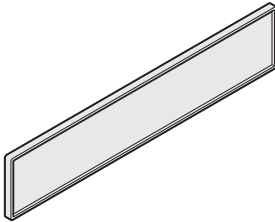

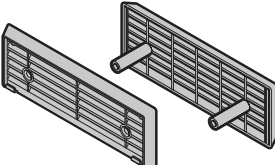
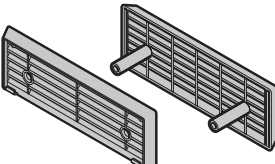

2. Accessories for door sections

Article	Pos. Description	Production period	Art. no.	Quantity	€
	2.22 Emblem holder 165,1 × 32,7 × 3.5 PMMA	01.01.2017 –	4014110	Unit(s) _____	/each
	2.23 Hörmann emblem 162,2 × 29,8	01.01.2017 –	4014605	Unit(s) _____	/each
	2.24 Ventilation grilles, black LPU 42 (42 mm)	01.07.2016 –	3041072	Unit(s) _____	/each
	2.25 Ventilation grilles, colour Infill (42 mm) based on RAL _____	01.07.2016 –	4014195 _____	Unit(s) _____ _____	/each + ⁶

- +⁴ Surcharges for painted window frames in Color, RAL to choose or matching Decograin, see page 37 / indicate colour article number.
 +⁶ Surcharges for painted ventilation grilles in Color, RAL to choose or matching Decograin, see page 37 / indicate colour article number.
 +⁷ Surcharge for window pane, see page 16 - 17 / indicate article number of the respective pane.
 +⁸ Surcharges for window frame inlay, see page 18 / indicate article number of the respective inlay.
 [+] No surcharge

ORDER	Customer no.: _____	Order no. / com.: _____	*Please take information from the data label!	
	Customer name: _____	Shipping address: _____	Order no.:	Year of manufacture:
	Place / date: _____	Stamp and signature _____	Serial no.:	Size:

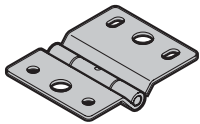
3. Fitting Parts for Door Sections

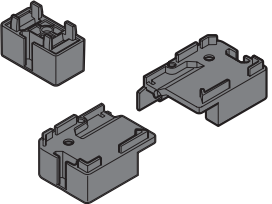
Article	Pos.	Description	Production period	Art. no.	Quantity	€
	3.1	Set: (set of 3) pan-head tapping screws 6.3 x 16 T30, Torx Liko	01.07.2012 –	4006180	Set _____	/ each
	3.2	Set: (set of 12) pan-head tapping screws 6.3 x 16 T30, Torx Liko	01.07.2012 –	4005186	Set _____	/ each
	3.3	Set: (set of 25) pan-head tapping screws 6.3 x 16 T30, Torx Liko	01.07.2012 –	4006181	Set _____	/ each
	3.4	Hinge type 2 H (track application H)	01.07.2012 –	3045119	Unit(s) _____	/ each
	3.5	HST bottom roller holder Retaining angle Bottom roller Roller axis Hex nut M8 with hollow flange	01.07.2012 – 01.07.2012 – 01.07.2012 – 01.07.2012 –	4004146	Set _____	/ each
	3.6	Set: Buffer sealing holder Buffer sealing holder (closing side) Plastic buffer sealing holder, op. r / cl. l (curve side) Plastic buffer sealing holder, op. l / cl. r (curve side)	01.07.2012 – 01.07.2012 – 01.07.2012 – 01.07.2012 –	4006422	Set _____	/ each

[+] No surcharge

ORDER	Customer no.: _____	Order no./com.: _____	*Please take information from the data label!	
	Customer name: _____	Shipping address: _____	Order no.:	Year of manufacture:
	Shipping address: _____	_____	Serial no.:	Size:
	_____	_____		
	Place / date: _____	_____	Stamp and signature	

3. Fitting Parts for Door Sections

Article	Pos.	Description	Production period	Art. no.	Quantity	€
	*	3.7 HST closing side edge op. l / cl. r Length _____ mm Surcharge for double locking (prepared) Surcharge for triple locking (prepared)	01.07.2012 –	4004812	m	/m
			01.07.2012 –	4005850		[+]
			01.07.2012 –	4005858		/ each
	*	3.8 HST closing side edge op. r / cl. l Length _____ mm Surcharge for double locking (prepared) Surcharge for triple locking (prepared)	01.07.2012 –	4008687	m	/m
			01.07.2012 –	4005850		[+]
			01.07.2012 –	4005858		/ each
	*	3.9 HST closing side edge, complete Length _____ mm Surcharge for double locking (prepared) Surcharge for triple locking (prepared)	01.07.2012 –	4005308	m	/m
			01.07.2012 –	4005850		[+]
			01.07.2012 –	4005858		/ each
	*	3.10 HST closing side edge, complete, intermediate width Length _____ mm Surcharge for double locking (prepared) Surcharge for triple locking (prepared)	13.08.2013 –	4011105	m	/m
			01.07.2012 –	4005850		[+]
			01.07.2012 –	4005858		/ each
	*	3.11 HST curve side edge, op. l / cl. r Length _____ mm	01.07.2012 –	4004813	m	/m
	*	3.12 HST curve side edge, op. r / cl. l Length _____ mm	01.07.2012 –	4008688	m	/m

[+] No surcharge

ORDER	Customer no.:	Order no. / com.:	*Please take information from the data label!	
			Order no.:	Year of manufacture:
	Customer name:		Serial no.:	Size:
	Shipping address:			
	Place / date:	Stamp and signature		

3. Fitting Parts for Door Sections

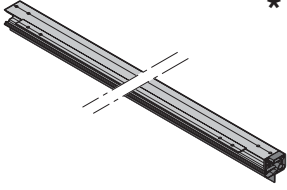
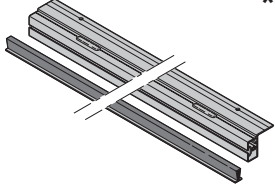
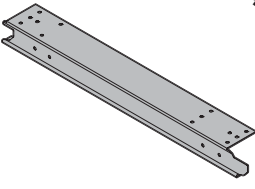
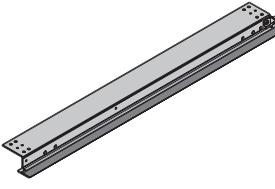
Article	Pos.	Description	Production period	Art. no.	Quantity	€
	*	3.13 HST curve side edge, complete Length _____ mm	01.07.2012–	4005319	m _____	/m
	*	3.14 HST curve side edge, complete, intermediate width Length _____ mm	13.08.2013–	4011106	m _____	/m
	*	3.15 End caps for door section right (op. l/cl. r) left (op. r/cl. l)	01.07.2012– 01.07.2012–	3047288 3047287	Unit(s) _____ _____	/each /each
	*	3.16 Set: HST bottom bracket, pre-assembled			Set	
		Set: Closing side Closing side, left Closing side, right Trap guard, (op. r/cl. l) Trap guard, (op. l/cl. r) Bottom seal	01.07.2012–	4005499	_____ _____	/each
		Set: Centre Centre, left Centre, right Trap guard, (op. r/cl. l) Trap guard, (op. l/cl. r) Bottom seal	01.07.2012–	4005100	_____ _____	/each
		Set: Curve side Curve side, left Curve side, right Bottom seal	01.07.2012–	4005101	_____ _____	/each

[+] No surcharge

ORDER	Customer no.: _____	Order no./com.: _____	*Please take information from the data label!	
	Customer name: _____	Shipping address: _____	Order no.:	Year of manufacture:
	Place / date: _____	Stamp and signature _____	Serial no.:	Size:

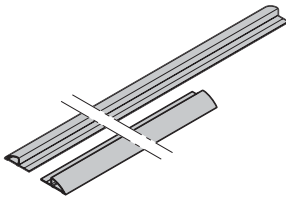
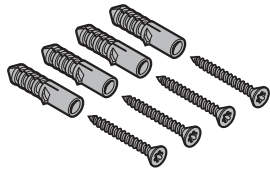
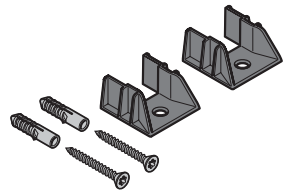
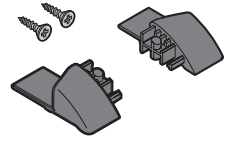

3. Fitting Parts for Door Sections

Article	Pos. Description	Production period	Art. no.	Quantity	€
	* 3.17 Set: HST floor rail Length _____ mm Floor rail, exterior Floor rail, interior	01.07.2012 – 01.07.2012 – 01.07.2012 –	4006359 4003976 4003977	Set _____	/m /m /m
	* 3.18 HST short floor rail Length _____ mm Curve side > 400 mm	01.07.2012 –	4005133	m _____	/m
	* 3.19 Curve side > 400 mm side floor rail HST Length _____ mm (1500 mm, LZ ≤ 4000 mm) (2800 mm, LZ > 4000 mm)	01.07.2012 –	4004850	m _____	/m
	3.20 Set: Floor rail fastening, lateral Woodscrew 6 × 50, plug S 8		4013733	Set _____	/ each
	3.21 Set: Guide channel, side Woodscrew 6 × 50, plug S 8	01.07.2012 – 01.02.2015	4013113	Set _____	/ each
	3.22 Set: Guide channel Guide channel, left Guide channel, right Countersunk head screw, 3.5 × 10	01.07.2012 – 01.07.2012 – 01.07.2012 –	4006358 4003978 4003979	Set _____	/ each

[+] No surcharge

ORDER	Customer no.: _____	Order no./com.: _____	*Please take information from the data label!	
	Customer name: _____	Shipping address: _____	Order no.:	Year of manufacture:
	Place / date: _____	Stamp and signature _____	Serial no.:	Size:

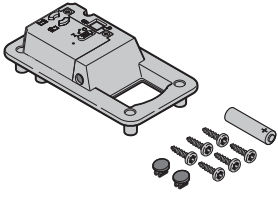
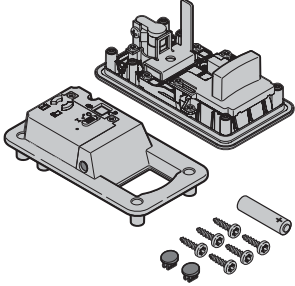
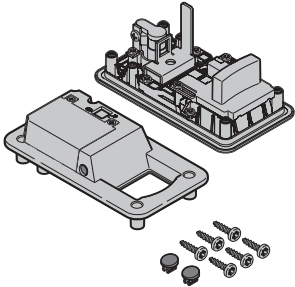
3. Fitting Parts for Door Sections

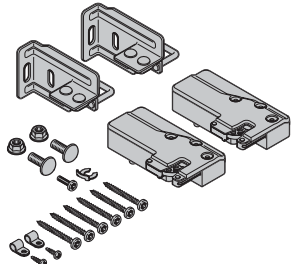
Article	Pos. Description	Production period	Art. no.	Quantity	€
	3.23 Retrofitting HST-FS Inner shell	01.07.2012 –	4003958	Unit(s) _____	/ each
	3.24 Door handle set HST-FS			Unit(s)	
	Plastic in RAL 9006	01.07.2012 –	4005220	_____	/ each
	Cast metal RAL 9016	01.07.2012 –	4006124	_____	/ each
	Cast metal brown	01.07.2012 –	4006125	_____	/ each
	Cast metal appearance brushed stainless steel	01.07.2012 –	4006126	_____	/ each
	3.25 Door handle set HST			Unit(s)	
	Plastic in RAL 9006	01.07.2012 –	4005578	_____	/ each
	Cast metal RAL 9016	01.07.2012 –	4006148	_____	/ each
	Cast metal brown	01.07.2012 –	4006149	_____	/ each
	Cast metal appearance brushed stainless steel	01.07.2012 –	4006150	_____	/ each
	3.26 Interior grip handle	01.06.1999 –	3047367	Unit(s) _____	/ each
	3.27 Set: HST locking			Set	
	op. r/cl. l	01.07.2012 –	4005330	_____	/ each
	op. l/cl. r	01.07.2012 –	4005389	_____	/ each
	Self-tapping screw 6.3 × 45, self-locking nut with serrated bearing M6, round-head screw M6 × 12, pipe clamp, drilling screw 4.2 × 13, lock washer, screw M5 × 12				

[+] No surcharge

ORDER	Customer no.: _____	Order no./com.: _____	*Please take information from the data label!	
	Customer name: _____	Shipping address: _____	Order no.:	Year of manufacture:
	Shipping address: _____	Place / date: _____	Serial no.:	Size:
	Place / date: _____	Stamp and signature		

3. Fitting Parts for Door Sections

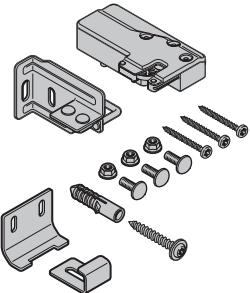
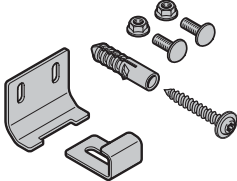
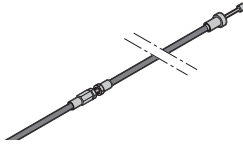
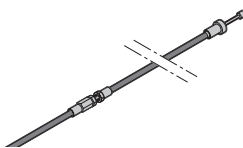
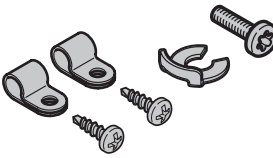
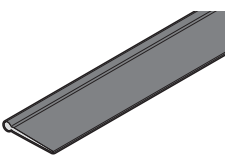
Article	Pos. Description	Production period	Art. no.	Quantity	€
	3.28 Set: Third HST lock op. r / cl. l op. l / cl. r Locking angle, locking hook, self-tapping screw 6.3 x 45, self-locking nut with serrated bearing M6, round-head screw M6 x 12, woodscrew 8 x 60, plug 10	01.07.2012 – 28.02.2017 01.07.2012 – 28.02.2017	4005550 4005557	Unit(s) _____ _____	/ each / each
	3.29 Set: Back HST lock Locking angle, locking hook, self-locking nut with serrated bearing M6, round-head screw M6 x 12, woodscrew 8 x 60, plug 10	01.07.2012 –	4004798	Unit(s) _____	/ each
	3.30 Bowden cable short HST for sectional doors in grid width	01.07.2012 –	4005372	Unit(s) _____	/ each
	3.31 Bowden cable long HST for panelled doors in grid width and doors with intermediate widths	27.06.2013 –	4009660	Unit(s) _____	/ each
	3.32 Set: fastening for Bowden cable HST Pipe clamp, drilling screw 4.2 x 13, lock washer, screw M5 x 12	11.07.2013 –	4009661	Unit(s) _____	/ each
	3.33 HST side seal, curve side Length _____ mm for doors in grid width	01.07.2012 –	4005134	Unit(s) _____	/m

[+] No surcharge

ORDER	Customer no.: _____	Order no. / com.: _____	*Please take information from the data label!	
	Customer name: _____	Shipping address: _____	Order no.:	Year of manufacture:
	Place / date: _____	Stamp and signature _____	Serial no.:	Size:

3. Fitting Parts for Door Sections

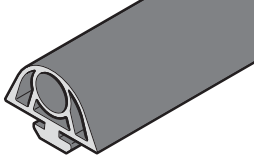
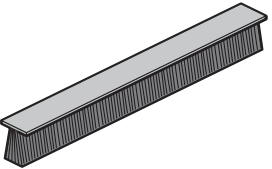
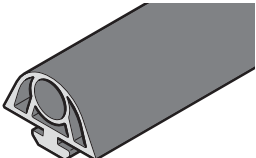
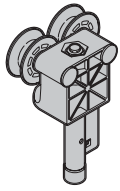
Article	Pos. Description	Production period	Art. no.	Quantity	€
	3.34 HST side seal, closing side, HG063 Length _____ mm	01.07.2012–	4005135	Unit(s) _____	/m
	3.35 Brush seal HST curve side Length _____ mm for doors with intermediate widths	14.06.2013–	4010630	Unit(s) _____	/m
	3.36 Buffer sealing secondary closing edge Length _____ mm	01.07.2012–	4006316	Unit(s) _____	/m
	3.37 HST slide carriage op. r/cl. l op. l/cl. r	01.07.2012– 01.07.2012–	4004770 4003981	Unit(s) _____ _____	/each /each

[+] No surcharge

ORDER	Customer no.: _____	Order no./com.: _____	*Please take information from the data label!	
	Customer name: _____	Shipping address: _____	Order no.:	Year of manufacture:
	Place / date: _____	Stamp and signature _____	Serial no.:	Size:

4. Fitting parts for frames

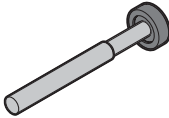
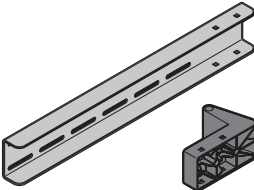
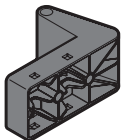
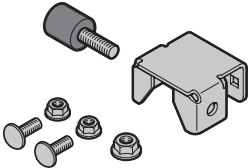
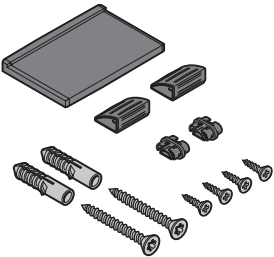
Article	Pos. Description	Production period	Art. no.	Quantity	€
	4.1 Guide roller Roller pin Roller	01.07.2012 – 01.07.2012 – 01.07.2012 –	4004143	Set _____	/ each
	4.2 Set: U profile, DS track application U-profile Guide roller holder	01.07.2012 – 01.07.2012 – 01.07.2012 –	4006419	Set _____	/ each
	4.3 Guide roller holder	01.07.2012 –	4004139	Unit(s) _____	/ each
	4.4 Buffer stop set Rubber buffer Buffer stop holder Hex nut M8 with hollow flange Round-head screw M6 x 12 Self-locking nut with serrated bearing M6	01.07.2012 – 01.07.2012 – 01.07.2012 –	4004842	Set _____	/ each
	4.5 Set: Two-part HST Top frame connector Floor rail connector Woodscrew 6 x 50 Plug S 8 Countersunk head screw 3.5 x 10	01.07.2012 – 01.07.2012 – 01.07.2012 –	4004859	Set _____	/ each

ORDER	Customer no.: _____	Order no./com.: _____	*Please take information from the data label!	
	Customer name: _____	Shipping address: _____	Order no.: _____	Year of manufacture: _____
	Place / date: _____	Stamp and signature _____	Serial no.: _____	Size: _____

4. Fitting parts for frames

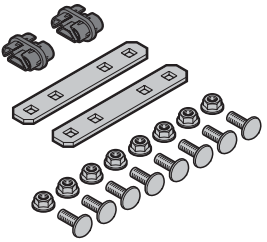
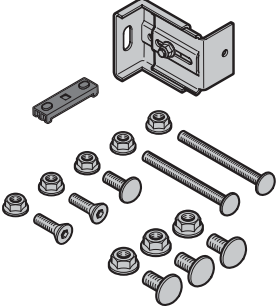
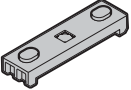
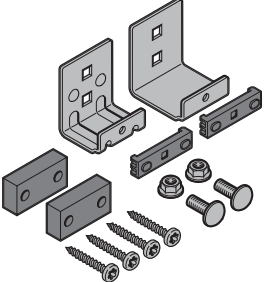
Article	Pos. Description	Production period	Art. no.	Quantity	€
	4.6 Set: HST track connector Track connector Connecting plate for track Round-head screw M6 × 12 Self-locking nut with serrated bearing M6	01.07.2012 – 01.07.2012 – 01.07.2012 –	4004860	Set	/ each
	4.7 Set: DS track application accessories Track wall holder Side wall spacer Self-tapping screw 6.3 × 16 C Round-head screw M6 × 16 Countersunk screw M6 × 16 Flat-head screw M6 × 70 Self-locking nut with serrated bearing M6 Flat-head screw M8 × 16 Hex nut M8 with hollow flange	01.07.2012 – 01.07.2012 – 01.07.2012 – 01.07.2012 – 01.07.2012 – 01.07.2012 – 01.07.2012 –	4004861	Set	/ each
	4.8 Side wall spacer	01.07.2012 –	4004131	Set	/ each
	4.9 Set: ES-fitting accessories Spacer for side wall, track wall holder, track wall holder + 15, support for roller holder, round-head screw M × 16, self-locking nut with serrated bearing M6		4011470	Set	/ each

ORDER	Customer no.:	Order no./com.:	*Please take information from the data label!	
	Customer name:	Shipping address:	Order no.:	Year of manufacture:
	Shipping address:		Serial no.:	Size:
	Place / date:		Stamp and signature	

4. Fitting parts for frames

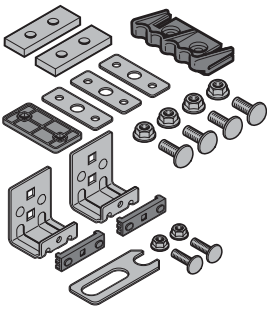
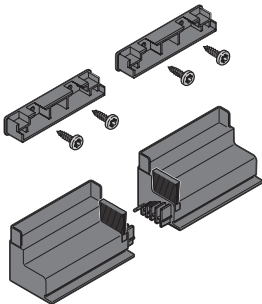
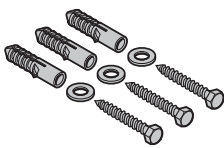
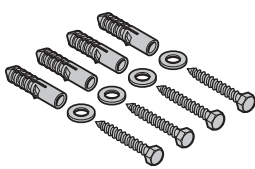
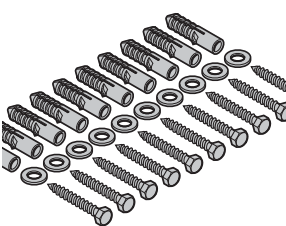
Article	Pos. Description	Production period	Art. no.	Quantity	€
	4.10 HST accessories set	01.07.2012 –	4005074	Set _____	/ each
	Spacer plate	01.07.2012 –			
	Spacer sheet 0.75 z	01.03.2000 –			
	Inside grip handle	01.06.1999 –			
	Upper track holder	01.07.2012 –			
Protective plug 8.8	01.07.2012 –				
Spacer plate anchor and screw, open ended spanner, self-locking nut with serrated bearing M6, round-head screw M6 x 16, spacer for side wall, spacer					
	4.11 HST frame fitting accessories set	01.07.2012 –	4004799	Set _____	/ each
	Frame shoe left, complete	01.07.2012 –			
	Frame shoe right, complete	01.07.2012 –			
	Fascia panel connector	01.01.2008 –			
Hexagon head screw M4 x 12 DIN 7500					
	4.12 Wall mounting set (set of 3)	01.07.2012 –	4004863	Set _____	/ each
	Wood screw 8 x 60				
	Washer 9 x 20 x 2				
Plug 10					
	4.13 Wall mounting set (set of 4)	01.07.2012 –	4005276	Set _____	/ each
	Wood screw 8 x 60				
	Washer 9 x 20 x 2				
Plug					
	4.14 Wall mounting set (set of 10)	01.07.2012 –	4005277	Set _____	/ each
	Wood screw 8 x 60				
	Washer 9 x 20 x 2				
Plug					

ORDER	Customer no.:	Order no./com.:	*Please take information from the data label!	
			Order no.:	Year of manufacture:
	Customer name:		Serial no.:	Size:
	Shipping address:			
	Place / date:	Stamp and signature		

4. Fitting parts for frames

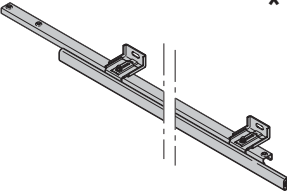
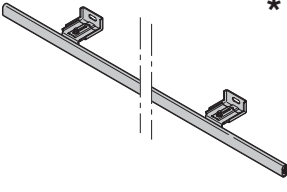
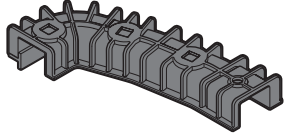
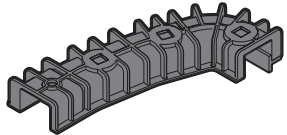
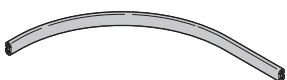
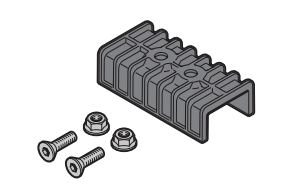
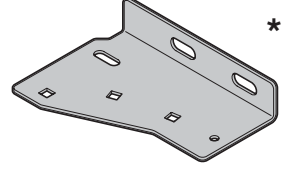
Article	Pos.	Description	Production period	Art. no.	Quantity	€
	*	4.15 Side track and guide rail, DS track application Length _____ mm Side guide rail Side track	01.07.2012 – 01.07.2012 –	4006420	Unit(s) _____	/m
	*	4.16 Side track, ES track application Length _____ mm Side track	01.07.2012 – 01.07.2012 –	4006421	Unit(s) _____	/m
		4.17 Guide curve, op. r / cl. l U-rail corner piece, left U-rail guide		4004412	Set _____	/each
		4.18 Guide curve, op. l / cl. r U-rail corner piece, right U-rail guide		4004413	Set _____	/each
		4.19 HST track radius Degrees _____	01.07.2012 –	4003973	Unit(s) _____	/each
		4.20 Set: HST guide rail connector Guide rail connector Countersunk screw M6 x 16 Self-locking nut with serrated bearing M6	01.07.2012 – 01.07.2012 –	4005410	Set _____	/each
	*	4.21 Guide curve holder HST, (op. r / cl. l)	01.07.2012 –	4003968	Unit(s) _____	/each

ORDER	Customer no.: _____	Order no./com.: _____	*Please take information from the data label!	
	Customer name: _____	Shipping address: _____	Order no.:	Year of manufacture:
	Shipping address: _____	Place / date: _____	Serial no.:	Size:
	Place / date: _____	Stamp and signature _____		

4. Fitting parts for frames

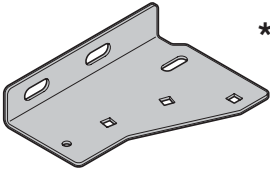
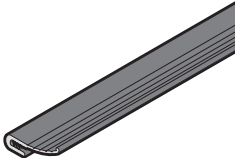
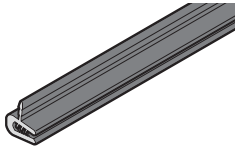
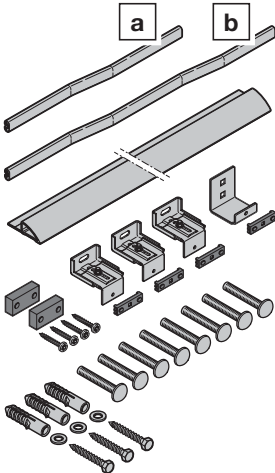
Article	Pos.	Description	Production period	Art. no.	Quantity	€
	*	4.22 Guide curve holder HST, (op. l/ cl. r)	01.07.2012 –	4004707	Unit(s) _____	/ each
		4.23 Lintel seal HG065 Length _____ mm	01.07.2012 –	4006412	Unit(s) _____	/m
		4.24 Side seal HG 066 Length _____ mm	01.07.2012 –	4006357	Unit(s) _____	/m
	*	4.25 Set: HST double S-curve Track, spacer for side wall, track wall holder, track wall holder + 15, support for roller holder, round-head screw M6 x 16, self-locking nut with serrated bearing M6, support for roller holder, self-tapping screw 6.3 x 45, inside floor rail, woodscrew 8 x 60, pane 9 x 20 x 2, plug 10, instructions	01.05.2015 –	4012832	Unit(s) _____	/ each

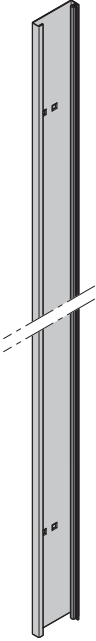
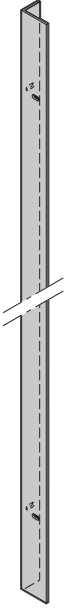

ORDER	Customer no.: _____	Order no./com.: _____	*Please take information from the data label!	
	Customer name: _____	Shipping address: _____	Order no.:	Year of manufacture:
	Place / date: _____	Stamp and signature _____	Serial no.:	Size:

4. Fitting parts for frames

Article	Pos.	Description	Production period	Art. no.	Quantity	€
	*	4.26 Side frame closing side	31.07.2013-	4010477	Unit(s) _____	/m
	*	4.27 Stop bracket HST	31.07.2013-	4011107	Unit(s) _____	/m

ORDER	Customer no.: _____	Order no./com.: _____	*Please take information from the data label!
	Customer name: _____	Shipping address: _____	Order no.: _____ Year of manufacture: _____
	Shipping address: _____	Place / date: _____	Serial no.: _____ Size: _____
	Place / date: _____	Stamp and signature _____	

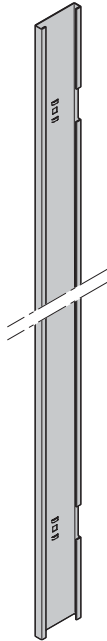
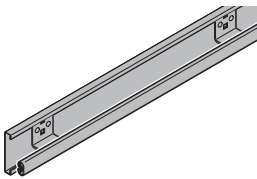
4. Fitting parts for frames

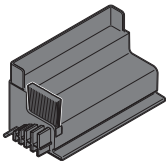
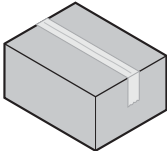
Article	Pos.	Description	Production period	Art. no.	Quantity	€
	*	4.28 Curve side frame	01.07.2012 –	4003964	Unit(s) _____	/m
	*	4.29 Top frame Note: Order lintel seal separately!	01.07.2012 –	4008654	Unit(s) _____	/m
		4.30 Set: frame shoe brushes (2 units)	01.07.2012 –	4006418	Set _____	/ each
		4.31 HST frame shoe, complete Left Right	01.07.2012 – 01.07.2012 –	4004814 4004815	Unit(s) _____ _____	/ each / each
	*	4.32 Frame box HST (I) Accessory box HST, accessory box door leaf HST, accessory box DS-fitting	13.02.2014 –	4012373	Unit(s) _____	/m

ORDER	Customer no.: _____	Order no./com.: _____	*Please take information from the data label!	
	Customer name: _____	Shipping address: _____	Order no.: _____	Year of manufacture: _____
	Place / date: _____	Stamp and signature _____	Serial no.: _____	Size: _____

4. Fitting parts for frames

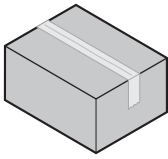
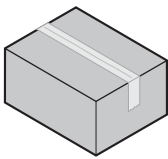
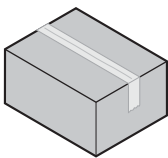
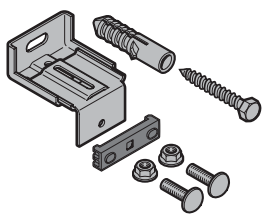
Article	Pos.	Description	Production period	Art. no.	Quantity	€
	*	4.33 Accessory box HST (II) (Track connector, guide rail anchor, fitting accessories for frame, buffer stop, floor rail, accessories, spacer sheets, inner handle, holder, spacers, wall fitting accessories, support for side track, rear locking, side guide connector, screws, connectors, connecting plates)	13.02.2014 –	4005127	Unit(s) _____	/ each
	*	4.34 Accessory box door leaf HST 1/2 (III) (Slide carriage, roller holder, hinges, track wall holder, components for S-curve, track connector, components for extended reveal depth, screws)	13.02.2014 –	4009395	Unit(s) _____	/ each
	*	4.35 Accessory box track application DS left (IV) right (IV) (U-profile, holder for track roller, track roller, holder for guide curve, guide curves, track wall holder, spacer, screws)	13.02.2014 – 13.02.2014 –	4004858 4005136	Unit(s) _____ _____	/ each / each
		4.36 Set: track wall holder	01.07.2012 –	4003967	Unit(s) _____	/ each

ORDER	Customer no.: _____	Order no./com.: _____	*Please take information from the data label!	
	Customer name: _____	Shipping address: _____	Order no.: _____	Year of manufacture: _____
	Place / date: _____	Stamp and signature _____	Serial no.: _____	Size: _____

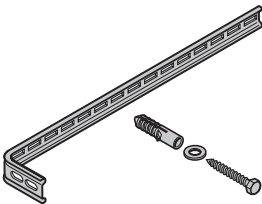
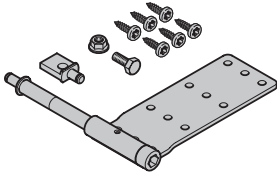
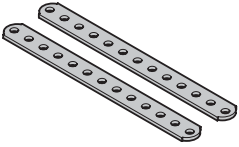
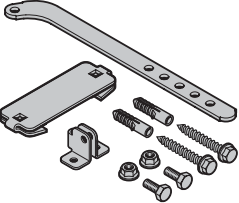
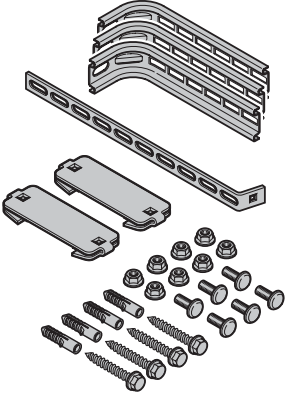

5. Operator Accessories

Article	Pos. Description	Production period	Art. no.	Quantity	€
	5.1 Set: Track anchor Track anchor Plug 10 Hexagon woodscrew 8 x 60 Washer 9 x 20 x 2	01.07.2012 –	4005840	Unit(s) _____	/ each
	5.2 Set: Ceiling fitting accessories	01.07.2012 –	437721	Unit(s) _____	/ each
	5.3 Set: Operator accessories HST track application ES	01.07.2012 –	437722	Unit(s) _____	/ each
	5.4 Set: HST operator accessories	01.07.2012 –	437723	Unit(s) _____	/ each
	5.5 Set: Accessory bag HST suspension for ceiling fitting	01.07.2012 –	437725	Unit(s) _____	/ each

[+] No surcharge

ORDER	Customer no.: _____	Order no./com.: _____	*Please take information from the data label!	
	Customer name: _____	Shipping address: _____	Order no.: _____	Year of manufacture: _____
	Place / date: _____	Stamp and signature _____	Serial no.: _____	Size: _____

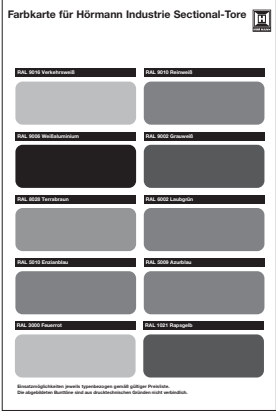
6. Surcharges

Article	Pos.	Description	Production period	Art. no.	Quantity	€
	6.1	Polyester-primer coating			Unit(s)	
		Standard Based on RAL 9016 Traffic white	01.07.2012 –	4005139	_____	[+]
		Color (Based on RAL 1015 Light ivory, based on RAL 3003 Ruby red, based on RAL 5011 Steel blue, based on RAL 5014 Pigeon blue, based on RAL 6005 Moss green based on RAL 6009 Fir green based on RAL 7016 Anthracite grey based on RAL 7030 Stone grey, based on RAL 7035 Light grey, based on RAL 7040 Window grey, based on RAL 8001 Ochre brown, based on RAL 8003 Clay brown, based on RAL 8028 Terra brown, based on RAL 9006 White aluminium, based on RAL 9007 Grey aluminium)	01.07.2012 –	4005140	_____	/m ²
	RAL to choose	01.07.2012 –	4005141	_____	/m ²	
	6.2	Surcharge for Decograin design			Unit(s)	
		Golden Oak	01.07.2014 –	4006080	_____	[+]
		Dark Oak	01.07.2014 –	4006081	_____	[+]
	Titan Metallic CH703	01.07.2014 –	4011566	_____	[+]	

[+] No surcharge

ORDER	Customer no.: _____	Order no./com.: _____	*Please take information from the data label!	
	Customer name: _____	Shipping address: _____	Order no.:	Year of manufacture:
	Place / date: _____	Stamp and signature _____	Serial no.:	Size:



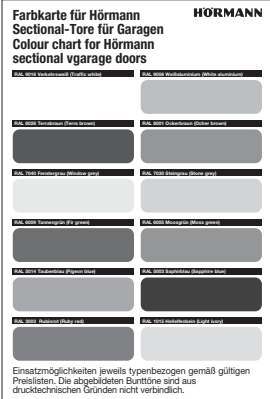



6. Surcharges

Article	Pos. Description	Production period	Art. no.	Quantity	€
	6.3 Polyester-primer coating for window frame Standard Based on RAL 9016 Traffic white Colour (Based on RAL 1015 Light ivory, based on RAL 3003 Ruby red, based on RAL 5011 Steel blue, based on RAL 5014 Pigeon blue, based on RAL 6005 Moss green, based on RAL 6009 Fir green, based on RAL 7016 Anthracite grey, based on RAL 7030 Stone grey, based on RAL 7035 Light grey, based on RAL 7040 Window grey, based on RAL 8001 Ochre brown, based on RAL 8003 Clay brown, based on RAL 8028 Terra brown, based on RAL 9006 White aluminium, based on RAL 9007 Grey aluminium, based on RAL 7613 Titan for New Silkgrain)	01.07.2012 –	4005266	Unit(s) _____	[+]
	RAL to choose	01.07.2012 –	4005267	_____	/each
	Matching Decograin	01.07.2012 –	4005268	_____	/each
		01.07.2012 –	4014933	_____	/each
	6.4 Polyester-primer coating for ventilation grille Colour RAL to choose Matching Decograin	01.07.2016 – 01.07.2016 – 01.07.2016 –	4014392 4014393 4014394	Unit(s) _____ _____ _____	/each /each /each

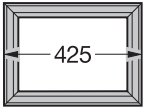
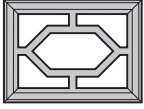
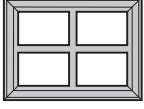
[+] No surcharge

ORDER	Customer no.: _____	Order no./com.: _____	*Please take information from the data label!	
	Customer name: _____	Shipping address: _____	Order no.: _____	Year of manufacture: _____
	Place / date: _____	Stamp and signature _____	Serial no.: _____	Size: _____

6. Surcharges

Article	Pos. Description	Production period	Art. no.	Quantity	€	
  	6.5 Surcharge per S-panel glazing (395 mm), for double-skinned door sections Only cut-out Standard design, clear S0, crystal structure / clear Standard design crystal structure / crystal structure Design no. 1, clear S1, crystal structure / clear Design no. 1, crystal structure / crystal structure Design no. 2, clear S2, crystal structure / clear Design no. 2, crystal structure / crystal structure	01.07.2012 – 01.07.2012 – 01.07.2012 – 01.07.2016 – 01.07.2012 – 01.07.2012 – 01.07.2016 – 01.07.2012 – 01.07.2012 – 01.07.2016 –	4014908 3053264 4014266 3053255 3053265 4014267 3053256 3053266 4014268 3053257	Unit(s) _____ _____ _____ _____ _____ _____ _____ _____ _____ _____ _____ _____	/each /each /each /each /each /each /each /each /each /each /each /each	
	    	6.6 Surcharge Motiv Design 451 Design 461, clear Design 461, crystal structure / crystal structure Design 452 Design 462, clear Design 462, crystal structure / crystal structure Design 454 Design 459 Design 469, clear Design 469, crystal structure / crystal structure Design 471 Design 481, clear / clear Design 481, crystal structure / crystal structure	01.03.2017 – 01.07.2016 – 01.07.2016 – 01.03.2017 – 01.07.2016 – 01.07.2016 – 01.03.2017 – 01.03.2017 – 01.07.2016 – 01.07.2016 – 01.03.2017 – 01.07.2016 – 01.07.2016 –	3059712 4005818 4005819 3059713 4005828 4005829 3059715 3070282 4005848 4005849 4014434 4014435 4014436	Unit(s) _____ _____ _____ _____ _____ _____ _____ _____ _____ _____ _____	/each /each /each /each /each /each /each /each /each /each /each

[+] No surcharge

ORDER	Customer no.:	Order no./com.:	*Please take information from the data label!	
	Customer name:	Shipping address:		Order no.:
	Shipping address:	Place / date:		Year of manufacture:
	Place / date:	Stamp and signature		Serial no.:
	Stamp and signature			Size:

General Terms and Conditions of Sale and Delivery (Issue 01.03.2016)

§ 1 General

1. Our General Terms and Conditions of Sale and Delivery apply to all deliveries and services in accordance with the contract concluded between us and the Customer.
2. Our General Terms and Conditions of Sale and Delivery are exclusively applicable; Customers' conditions which conflict with or deviate from our conditions are not recognised unless we have agreed to them expressly in writing.
3. Our General Terms and Conditions of Sale and Delivery apply only to transactions with business entities as per § 14 of the German Civil Code [BGB].

§ 2 Entry into Contract

1. Our offers are without engagement and non-binding, unless otherwise agreed. Decisive for nature and scope is our order confirmation. We reserve the right to make technical changes as well as changes in form, colour and/or weight insofar as is reasonable.
2. The offer shall be regarded as accepted only when an order confirmation is issued or the goods are dispatched. The issue of a confirmation of receipt or the receipt of a telephone order do not constitute a binding acceptance. In the case of goods that have to be made to order, following our written confirmation the contract shall be regarded as having been entered into even if details of its execution which may affect price and delivery remain to be clarified. The right to make design and form changes during the delivery period is reserved, provided that the subject of delivery and its function and appearance are not fundamentally altered thereby. There will be no resulting change in price.
3. In respect of figures, drawings, calculations and similar documents, we reserve ownership and copyright. This likewise applies to such documents designated as "confidential". These documents may not be made available to third parties without our express prior approval.

§ 3 Prices and Terms of Payment

1. Unless otherwise specified in the order confirmation, our prices apply "ex works", excluding transport and assembly, which shall be invoiced separately. Costs for packaging, with the exception of small and spare parts, are included. The value added tax as required by law is not included in our prices; this tax will be shown separately on the invoice at the legal rate applicable on the date of invoicing.
2. Our invoices shall be due to be paid net (without deduction) within 30 days. The deduction of discounts requires a special agreement in writing.
3. Should the price of materials increase taxes or levies be increased after the contract has been concluded, we shall be entitled to adjust our prices accordingly if there are at least 4 months between entry into contract and intended delivery.
4. Should the Customer commission not only delivery but also assembly or similar services, these shall be invoiced by the hour unless a fixed rate has been agreed expressly. Our valid Terms and Conditions of Installation shall apply to all assembly services.
5. We are entitled, even in the case of conflicting Customer conditions, to set off payments against the Customer's previous debts. If costs and interest have already incurred, we are entitled to set off the payment against the costs, then to the interest and finally to the main service.
6. We are also entitled to make our remaining claims immediately payable and render the execution of all further services subject to an advance payment or provision of security, if we become aware of circumstances that call the solvency and the credit standing of the Customer into question, in particular in the event of default in payment. The right to claim further damages will remain unaffected.
7. During the delay, the Customer cannot invoke the right to possession. Any claim for return on our side during a delay on the Customer's side shall only be considered as withdrawal from the contract if we have specified this expressly in writing.
8. The Customer shall only have the right to offsetting if the Customer's counterclaims have been determined without further legal recourse, beyond dispute or if the counterclaims have been recognised by us. The Customer can only exert a right of retention if and when the counterclaim rests on the same contractual relationship.

§ 4 Place of Fulfilment, Transfer of Risk

1. Unless otherwise specified in the order confirmation, a delivery "ex works" (INCOTERMS 2010) has been agreed. The risk of accidental loss or deterioration of the goods purchased passes to the Customer upon hand-over of the goods to the shipping agent, the freight forwarder or the person or establishment otherwise appointed to execute the shipment. This shall likewise apply in case of partial delivery or if we have taken over other services (e.g. shipping or assembly).
2. Should the Customer be in default of acceptance, the risk of accidental loss or deterioration of the goods purchased shall pass to the Customer. Any storage costs incurred shall comply with § 5 No. 3.
3. If carriage paid delivery of the goods has been agreed, the means of transport must be unloaded immediately by the Customer. Waiting times will always be at the Customer's expense. Direct delivery to site shall always be regarded as on truck on an even, drivable road. Unloading including transportation to the place of use or storage is the responsibility of the Customer who in the event of delay must bear the cost and risk of unloading, stacking, storage or return transport. The recipient acting on behalf of the Customer at the place of unloading shall be regarded as authorised to accept the load with binding effect.

§ 5 Period of Delivery

1. The period of delivery specified by us shall only begin after clarification of all technical questions.
2. Information on delivery dates shall be considered the expected periods of delivery and are always subject to correct and timely delivery by suppliers and/or other manufacturers to us. The Customer may only set a time limit for the supply/performance if the expected delivery date has been exceeded by more than three weeks. This time limit must be reasonable and must amount to a minimum of three weeks. Claims for damages due to non-compliance with an expected delivery date are excluded. Delays in supply and performance as a result of force majeure or as a result of events which materially impede or prevent us from making delivery – including in particular subsequent material sourcing difficulties for which we are not responsible, interruption of operations, strikes, lockouts, official directives, etc., even if these affect our suppliers or sub-suppliers – will be notified to the Customer immediately. Events of this type entitle us to withdraw from the contract either in whole or in part if the order is not yet completed. In the event of withdrawal, any compensating measures already performed by the Customer shall be reimbursed immediately.
3. Should the Customer be in delay of acceptance, we are entitled to store the goods at the Customer's risk and expense. For the corresponding storage costs, we can optionally demand reimbursement of the actually incurred costs or of a fixed rate of 5% of the invoice sum for each commenced month. This also applies to storage by us. The Customer has the right to prove less damage in the event of a claim to flat-rate damage reimbursement.
4. Should, after the time limit set by us has expired, the Customer refuse to accept the goods or declare to no longer want to accept the goods without entitlement to do so, we can also demand damage compensation due to non-fulfilment.
5. Partial deliveries are permissible to a reasonable extent.

§ 6 Reservation of Title

1. We reserve ownership of the goods until complete payment of all claims from the ongoing business relationship with the Customer. Should the value of the reserved goods exceed the claims to be secured from the ongoing business relationship with the Customer by more than 20%, we are obligated to release the reserved goods on Customer request. The selection of the securities to be released is at our discretion.
2. While retention of title is in effect, the Customer is obligated to treat the goods purchased with care and sufficiently insure them against fire, water and theft at their value when new and at the Customer's expense. Any claims asserted for damages by the Customer against the insurer or other third parties due to deterioration of the reserved goods are right now signed over to us at the amount of the invoice sum. Should maintenance and inspection work be required, the Customer shall perform said work regularly at the Customer's own expense. The Customer must inform us immediately and in writing of all access of third parties to the goods, in particular of all foreclosure and any damage to or destruction of the goods. The Customer must inform us of a change in possession of the goods as well as a change in the Customer's address immediately. The Customer must reimburse us of all damage and costs caused by a violation of this obligation and resulting necessary intervention measures to prevent access of third parties to the goods. In the event of access by third parties, the Customer must also provide us with the necessary help to exercise our rights.
3. The Customer is not permitted to pledge reserved goods nor assign them as security.
4. Processing or transformation of goods supplied subject to the reservation of title is always undertaken by the Customer on our behalf. Should the reserved goods be combined or processed with other items, the reservation of title shall continue for the processed or combined goods. If the reserved goods are processed or combined inextricably with items which are not our property, we shall acquire ownership of the new object in the ratio of the invoice value of the reserved goods to the invoice value of the other goods used at the time of processing or combination. The resulting co-ownership rights shall be deemed to be reserved goods in accordance with these terms and conditions. If our goods are joined or combined inextricably with other movable items into a single object and the other object is to be considered the main object, the Customer shall concede proportionate joint ownership to us should the main object belong to the Customer. In the aforementioned cases, the Customer here and now assigns all ownership rights to the processed, joined, or combined goods to us. Instead of a transfer, the Customer shall hold the processed, joined, or combined object in safe custody on our behalf. For the object resulting from processing, use, or combination, the same applies in all other respects as for reserved goods.
5. The Customer is entitled to resell goods supplied subject to reservation of title by way of due and proper business transactions. The Customer here and now assigns all claims with all rights arising from the resale of the reserved goods to us in full. We accept this assignment. Should the Customer sell the reserved goods – after processing/combination – together with goods not belonging to the Customer, the Customer here and now assigns to us the claims resulting from resale at the value at new of the reserved goods along with all ancillary rights. We accept this assignment right now. The Customer is entitled to collect this claim even after assignment. However, we reserve the right to collect the claim ourselves as soon as the Customer fails to properly meet payment obligations and enters into default, or reasonable doubt about the Customer's solvency and credit standing exists. On our request, the amount of the assigned claim, the person of the debtor and all other information required for collection must be provided, the corresponding documents be handed over and the debtor be notified of the assignment.
6. The right to further processing and resale ends with withdrawal from the contract.
7. During the Customer's standard business hours, we are at all times entitled to enter the offices and operating premises to check the reserved goods and to take possession of the reserved goods insofar as the Customer is unable to invoke rights to possession.

§ 7 Defect Claims

1. The Customer shall be entitled to claims for defect only if the Customer's duties to inspect and report pursuant to § 377 of the German Commercial Code [HGB] have been duly complied with. In the event that complaints are not reported in due time and/or in due form, the goods shall be regarded as accepted.
2. For the delivery of objects, we are free to decide to affect supplementary performance either by repair or replacement. If supplementary performance fails, the Customer can at his choice demand a reduction, withdrawal or compensation. In the event of only minor defects the Customer has no right to withdrawal.
3. As a matter of principle, the nature of the goods purchased shall be defined solely by the manufacturer's product description/order confirmation. Public statements, recommendations or advertisements by the manufacturer do not constitute contractual statements as to the nature of the goods.
4. The period of limitation for defect claims is based on § 438, Para. 1, No. 2 of the German Civil Code [BGB] as long as no deviating time limits have been expressly agreed.
5. The Customer is not entitled to assign claims for material defects.

§ 8 Liability

1. We accept liability within legal provisions, provided the Customer asserts claims for damages that are based on intent or gross negligence. In the event of minor negligence, our liability is limited to predictable, typically occurring damage. We are not liable in the event of minor negligence of non-essential contractual obligations whose violation does not threaten the performance of the contract. This also applies to breach of duty by our legal representatives or vicarious agents.
2. Liability for negligent injury to life or limb or the impairment of a person's health remains unaffected from the above limitations of liability; this also applies to Customer claims according to the German Product Liability Act [Produkthaftungsgesetz].

§ 9 Concluding Provisions

1. The law of the Federal Republic of Germany shall apply. The UN Convention on the International Sale of Goods shall not be applicable.
2. To take legal effect, subsidiary agreements and amendments must be confirmed in writing. This likewise applies to any modification of the clause stipulating the written form.
3. Unless otherwise specified in the order confirmation, our headquarters are the place of fulfilment. The exclusive place of jurisdiction for all disputes arising from this contract shall be Bielefeld, Germany.
4. Insofar as individual terms of the contract including these General Terms and Conditions should be or become ineffective either in whole or in part, this shall not affect the validity of the remaining provisions.

Hörmann: Quality without Compromise



Hörmann KG Amshausen, Germany



Hörmann KG Antriebstechnik, Germany



Hörmann KG Brandis, Germany



Hörmann KG Brockhagen, Germany



Hörmann KG Dissen, Germany



Hörmann KG Eckelhausen, Germany



Hörmann KG Freisen, Germany



Hörmann KG Ichttershausen, Germany



Hörmann KG Werne, Germany



Hörmann Alkmaar B.V., Netherlands



Hörmann Legnica Sp. z o.o., Poland



Hörmann Beijing, China



Hörmann Tianjin, China



Hörmann LLC, Montgomery IL, USA



Hörmann Flexon LLC, Burgettstown PA, USA



Shakti Hörmann Ltd., India

Hörmann is the only manufacturer worldwide that offers you a complete range of all major building products from one source. We manufacture in highly-specialised factories using the latest production technologies. The close-meshed network of sales and service companies throughout Europe, and activities in the USA and Asia, make Hörmann your strong partner for first-class building products, offering “Quality without Compromise”.

GARAGE DOORS
OPERATORS
INDUSTRIAL DOORS
LOADING EQUIPMENT
HINGED DOORS
DOOR FRAMES

HÖRMANN