



Series 2000 Garage Door Price List

01.04.2020

HÖRMANN



HÖRMANN IS ALWAYS COMMITTED TO EXCELLENCE: “In Engineering, in User Safety and in Design.”

All our products are third party tested to the highest standards and are certified to the high safety requirements and performance characteristics of the European Standard 13241-1.

This gives you the reassurance that your purchase of a Hörmann product is a safe investment. We are also committed to our national network of Garage Door Specialist Distributors.

These are independent businesses, who believe in customer service and have skills to advise you on the best product for your property, also providing quality fitting and finishing.

“A great product performs at its best when fitted by experts.”

Door Operating Systems

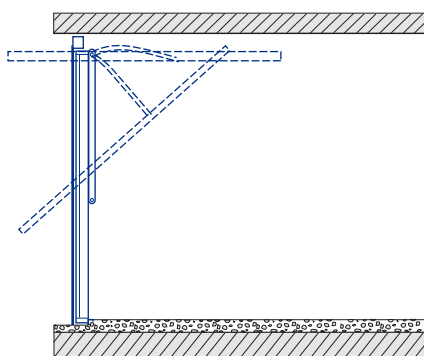

Canopy Operating Gear

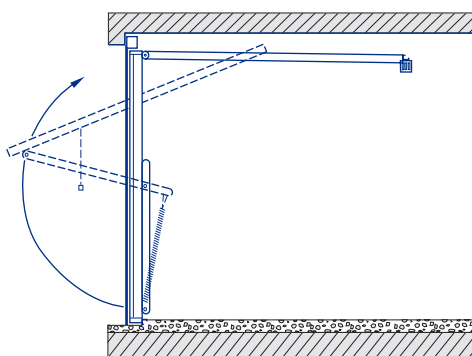

Retractable Operating Gear

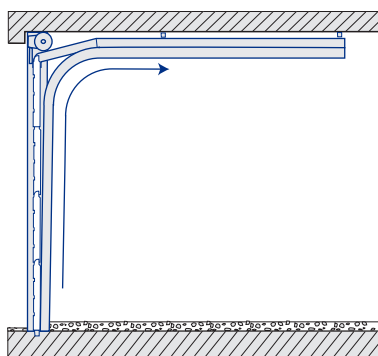

Sectional Operating Gear

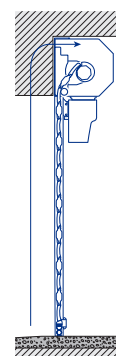

RollMatic Operating Gear

Contents



Up-and-over garage doors

Canopy and retractable with steel infill	2
Canopy and retractable with timber infill	6



Sectional garage doors

// NEW

Sectional garage doors LTE 42 Single-skinned steel sectional doors	10
Sectional garage doors LPU 42 Double-skinned steel sectional doors	12
Duragrain & Planar surface finishes	17
Optional extras and window designs	19



RollMatic roller garage doors

RollMatic roller garage doors	20
RollMatic side doors	24
RollMatic TDL	25
RollMatic OD	26



Garage door operators

// NEW

Garage door operators	30
Series 4 door operators	30
Operator accessories	30

Hörmann Up-and-Over Doors

Canopy & retractable with steel infill



SINGLE DOORS		Door sizes BR		2001 Vertical		2002 Horizontal		2601 Elegance		2602 Finesse		2101 Ilkley		2103 Caxton	
		Imperial	Metric	CAN.	RET.	CAN.	RET.	CAN.	RET.	CAN.	RET.	CAN.	RET.	CAN.	RET.
6'6" x	6'6"	1981 x 1981	676	717	594	635									
	7'0"	1981 x 2134	676	717	594	635									
6'10" x	6'4"	2083 x 1930	674	715	608	649									
	6'6"	2083 x 1981	674	715	622	663									
7'0" x	7'0"	2083 x 2134	691	732	645	686									
	6'4"	2134 x 1930	677 ¹	718 ¹	615	656					1125	1166			
6'6"	2134 x 1981	658¹	699¹	594¹	635¹	833	874	833	874	1125	1166	1085	1126		
	2134 x 2134	682¹	723¹	623¹	664¹	880	921	880	921	1137	1178	1092	1133		
	2134 x 2286		834		778										
7'3" x	6'4"	2210 x 1930	711 ¹	752 ¹	669	710									
	6'6"	2210 x 1981	714	755	672	713									
	7'0"	2210 x 2134	724	765	679	720									
7'5" x	6'6"	2261 x 1981	720	761	669	710					1167	1208			
	7'0"	2261 x 2134	807	848	761	802					1181	1222			
7'6" x	6'4"	2286 x 1930	735	776	669	710					1167	1208			
	6'6"	2286 x 1981	735 ¹	776 ¹	669 ¹	710 ¹	924	965	924	965	1167	1208			
	7'0"	2286 x 2134	807 ¹	848 ¹	763 ¹	804 ¹	1064	1105	1064	1105	1181	1222	1160	1201	
	7'6"	2286 x 2286		907		932									
7'8" x	6'4"	2337 x 1930	832	873	768	809									
8'0" x	6'4"	2438 x 1930	870	911	769	810					1238	1279			
	6'6"	2438 x 1981	870 ¹	911 ¹	769	810	1092	1133	1092	1133	1238	1279			
	7'0"	2438 x 2134	900 ¹	941 ¹	785	826	1137	1178	1137	1178	1250	1291			
	7'6"	2438 x 2286		1021		908									
	8'0"	2438 x 2438		1057		944									
8'6" x	6'6"	2590 x 1981		983		873									
	7'0"	2590 x 2134		1065		905									
9'0" x	6'6"	2743 x 1981		1134		1088									
	7'0"	2743 x 2134		1239		1141									
10'0" x	6'6"	3048 x 1981		1375		1363									
	7'0"	3048 x 2134		1375		1363									

Prices Marked ¹ – optional Terra brown RAL 8028 available. Surcharge on door, see page 5.

DOUBLE DOORS Internal frame sizes BR		2001 Vertical	2002 Horizontal	2601 Elegance	2602 Finesse	2101 Ilkley	Style Not Available
Imperial	Metric	Retractable	Retractable	Retractable	Retractable	Retractable	
11'0" x	6'6"	3353 x 1981	1495 *	1495 *			
	7'0"	3353 x 2134	1506 *	1506 *			
12'0" x	6'6"	3658 x 1981	1569 *	1569 *			
	7'0"	3658 x 2134	1581 *	1581 *			
13'0" x	6'6"	3962 x 1981	1709 *	1709 *			
	7'0"	3962 x 2134	1720 *	1720 *			
14'0" x	6'6"	4267 x 1981	1645	1645		2277 *	
	7'0"	4267 x 2134	1645	1645		2277	

Prices Marked * – Not available ex-stock, delivery 4 – 5 weeks

MATCHING SIDE DOORS Ordering sizes	2001 Vertical	2002 Horizontal	2601 Elegance	2602 Finesse	Style Not Available	Style Not Available
875 x 1875	459	961 ²	899 ²	899 ²		
875 x 2000	459	961 ²	899 ²	899 ²		
875 x 2125	459 ²	961 ²	899 ²	899 ²		
1000 x 2000	487 ²	993 ²	1027 ²	1027 ²		
1000 x 2125	487	993 ²	1027 ²	1027 ²		

Prices Marked ² – Not available ex-stock, delivery 4 – 8 weeks





2003 Chevron		2004 Georgian		2304 Georgian with windows		2104 Marquess		2504 Countess		75mm steel framed doors Recommended structural opening sizes allowing tolerance of 10mm on width & 5mm on height For steel frame options see page 5	
CAN.	RET.	CAN.	RET.	CAN.	RET.	CAN.	RET.	CAN.	RET.	Imperial	Metric
		822	863							7'0" x 6'8½"	2135 x 2044
		835	876							7'0" x 7'2¾"	2135 x 2199
		832	873							7'4" x 6'6½"	2235 x 1994
		833	874							7'4" x 6'8½"	2235 x 2044
		893	934							7'4" x 7'2¾"	2235 x 2199
		833	874							7'6" x 6'6½"	2284 x 1994
702	743	833¹	874¹	1141	1182	833	874	833	874	7'6" x 6'8½"	2284 x 2044
748	789	880¹	921¹	1189	1230	880	921	880	921	7'6" x 7'2¾"	2284 x 2199
										7'6" x 7'8½"	2284 x 2350
		924	965							7'9¼" x 6'6½"	2365 x 1994
										7'9¼" x 6'8½"	2365 x 2044
										7'9¼" x 7'2¾"	2365 x 2199
		924	965							7'11" x 6'8½"	2411 x 2044
		1064	1105							7'11" x 7'2¾"	2411 x 2199
		924	965							8'0" x 6'6½"	2436 x 1994
		924 ¹	965 ¹	1232	1273	924	965			8'0" x 6'8½"	2436 x 2044
		1064 ¹	1105 ¹	1372	1413	1064	1105			8'0" x 7'2¾"	2436 x 2199
										8'0" x 7'8½"	2436 x 2350
		1106	1147							8'2" x 6'6½"	2489 x 1994
		1092	1133							8'6" x 6'6½"	2589 x 1994
		1092	1133			1092	1133			8'6" x 6'8½"	2589 x 2044
1020	1061	1137	1178			1137	1178			8'6" x 7'2¾"	2589 x 2199
										8'6" x 7'8½"	2589 x 2350
										8'6" x 8'2¾"	2589 x 2503
										9'0" x 6'8½"	2741 x 2044
										9'0" x 7'2¾"	2741 x 2199
			1431							9'6" x 6'8½"	2894 x 2044
			1456							9'6" x 7'2¾"	2894 x 2199
										10'6" x 6'8½"	3199 x 2044
										10'6" x 7'2¾"	3199 x 2199
2003 Chevron	2004 Georgian	2304 Georgian with windows	2104 Marquess	Style Not Available						Imperial	Metric
Retractable	Retractable	Retractable	Retractable								
										11'6" x 6'8½"	3504 x 2044
										11'6" x 7'2¾"	3504 x 2199
										12'6" x 6'8½"	3809 x 2044
										12'6" x 7'2¾"	3809 x 2199
										13'6" x 6'8½"	4114 x 2044
										13'6" x 7'2¾"	4114 x 2199
2159 *	1772	2392 *	1772 *							14'6" x 6'8½"	4419 x 2044
2159 *	1772	2392 *	1772 *							14'6" x 7'2¾"	4419 x 2199
2003 Chevron	2004 Georgian	2304 Georgian with windows	2104 Marquess	Style Not Available							
1206 ²	899 ²	1061 ²	899 ²								
1206 ²	899 ²	1061 ²	899 ²								
1206 ²	899 ²	1061 ²	899 ²								
1224 ²	1027 ²	1189 ²	1027 ²								
1224 ²	1027 ²	1189 ²	1027 ²								

Hörmann Up-and-Over Doors

Canopy & retractable with steel infill

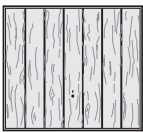
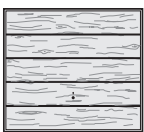

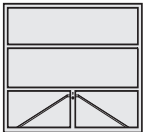
SINGLE DOORS											
Door sizes BR		Vertical Decograin Golden Oak or Rosewood	Horizontal Decograin Golden Oak or Rosewood	Georgian Decograin Golden Oak or Rosewood	Marquess Decograin Golden Oak or Rosewood	2011 Open for infill					
Imperial	Metric	CAN.	RET.	CAN.	RET.	CAN.	RET.	CAN.	RET.	CAN.	RET.
6'6" x 6'6"	1981 x 1981									573	614
6'6" x 7'0"	1981 x 2134									573	614
6'10" x 6'4"	2083 x 1930									573	614
6'10" x 6'6"	2083 x 1981										
6'10" x 7'0"	2083 x 2134										
7'0" x 6'4"	2134 x 1930									573	614
7'0" x 6'6"	2134 x 1981	846	887	753	794	996	1037	996	1037	573	614
7'0" x 7'0"	2134 x 2134	870	911	814	855	1044	1085	1044	1085	608	649
7'0" x 7'6"	2134 x 2286										
7'3" x 6'4"	2210 x 1930									635	676
7'3" x 6'6"	2210 x 1981										
7'3" x 7'0"	2210 x 2134										
7'5" x 6'6"	2261 x 1981	901	942	833	874					635	676
7'5" x 7'0"	2261 x 2134	970	1011	927	968					655	696
7'6" x 6'4"	2286 x 1930									635	676
7'6" x 6'6"	2286 x 1981	901	942	833	874	1106 ⁴	1147 ⁴	1106	1147	635	676
7'6" x 7'0"	2286 x 2134	970	1011	927	968	1277	1318	1277	1318	654	695
7'6" x 7'6"	2286 x 2286										
7'8" x 6'4"	2337 x 1930									665	706
8'0" x 6'4"	2438 x 1930									665	706
8'0" x 6'6"	2438 x 1981	1036	1077	919	960	1298	1339	1298	1339	665	706
8'0" x 7'0"	2438 x 2134	1067	1108	952	993	1344 ³	1385 ³	1344	1385	665	706
8'0" x 7'6"	2438 x 2286										
8'0" x 8'0"	2438 x 2438										
8'6" x 6'6"	2590 x 1981										
8'6" x 7'0"	2590 x 2134										
9'0" x 6'6"	2743 x 1981										777
9'0" x 7'0"	2743 x 2134										790
10'0" x 6'6"	3048 x 1981										960
10'0" x 7'0"	3048 x 2134										960
Prices Marked ³ – Only available in Rosewood. Prices Marked ⁴ – only available in Golden oak											
DOUBLE DOORS Internal frame sizes BR		Style Not Available	Style Not Available	Style Not Available	Style Not Available	Style Not Available	Style Not Available	Style Not Available	Style Not Available	Style Not Available	2011 Open for infill
Imperial	Metric										Retractable
11'0" x 6'6"	3353 x 1981										1892
11'0" x 7'0"	3353 x 2134										1978
12'0" x 6'6"	3658 x 1981										2005
12'0" x 7'0"	3658 x 2134										2079
13'0" x 6'6"	3962 x 1981										2104
13'0" x 7'0"	3962 x 2134										2172
14'0" x 6'6"	4267 x 1981										1966
14'0" x 7'0"	4267 x 2134										1966
Prices Marked * – Not available ex-stock, delivery 4 – 5 weeks											
MATCHING SIDE DOORS Ordering sizes	2001 Golden Oak or Rosewood	2002 Golden Oak or Rosewood	2004 Golden Oak or Rosewood	2104 Golden Oak or Rosewood	2011 Open for infill						
Prices Marked ² – Not available ex-stock, delivery 4 – 8 weeks											
875 x 1875	1000 ²	1000 ²	1000 ²	1000 ²	459						
875 x 2000	1006 ²	1006 ²	1006 ²	1006 ²	459						
875 x 2125	1013 ²	1013 ²	1013 ²	1013 ²	459						
1000 x 2000	1149 ²	1149 ²	1149 ²	1149 ²	487						
1000 x 2125	1157 ²	1157 ²	1157 ²	1157 ²	487						



The door leaf and optional box section steel frame are made of galvanised material that is polyester powder coated on both sides.

This finish is extremely durable and the standard colour is Traffic white RAL 9016.

Other colours are available listed in optional extras below.

To help maintain the aesthetic appearance of your door and prevent the build up of dirt, salt and other corrosive substances the door should be washed with a mild soap-based solution on a regular basis.

If the door is located near the coast it is important that the door panel and frame should be washed at least every 2 months.

We also suggest that all other components are brushed down on a regular basis to prevent the build up of dirt and dust etc.

The window frames on the Georgian and Ilkley doors are UPVC and white as standard.

These frames are a 2-part construction with the window material sandwiched between and frames screwed together from the back for security.

The finish of the Decograin doors is a synthetic foil-coated timber design outside (inside primer white).

The leaf frame and fixing frame is a matching powder coating.



For further choice of exciting door designs in steel, traditional or contemporary, with a vast range of sizes and increased range of colours, ask your garage door specialist about the N 80 Up-and-Over garage doors available to special order.

Optional extras for Steel Doors	Price
75mm Steel fixing frame for either canopy or retractable geared single doors. Factory fitted	123
75mm Steel fixing frame for either canopy or retractable geared single doors. Factory fitted with frame to compliment Decograin	123
75mm Steel fixing frame for DOUBLE retractable geared doors, when ordered with the door	194
60mm Steel fixing frame for canopy geared doors only. Factory fitted	127
60mm Steel fixing frame for canopy geared doors only. Factory fitted with frame to compliment Decograin	127
Please note: Factory fitted 8' high frame not available	
Prices marked ¹ – optional Terra Brown RAL 8028 available. Surcharge on door	35
Retractable plus gear for retractable doors up to 7'6" wide giving extra drive through width	
Surcharge on retractable price	64
4 point locking kit for extra security, factory fit with door order or retrofit – single door sizes only	58
3 point locking kit for extra security, factory fit with door (this cannot be retrofitted). Available for 2001 side doors only	100
Window options for 2304 Georgian style door – Plain, crossed or diamond style with crystal glazing	Incl.
Colours are available to special order in the following styles:	
2001 Vertical, 2002 Horizontal, 2101 Ilkley available in all the listed sizes	
2004 Georgian, 2304 Georgian with windows and 2104 Marquess are available in	
7066, 7070, 7566, 7570, 7666, 7670 and 8066, 8070 sizes only	
Please note: Caxton, Chevron, Elegance, Finesse and Countess steel up-and-over doors are only available in white	
Colours:	
Terra Brown RAL 8028, Signal Blue RAL 5005, Steel Blue RAL 5011, Moss Green RAL 6005, Ruby Red RAL 3003, Jet Black RAL 9005	
Includes matching frame if ordered with door. White frame RAL 9016 also available, please specify when ordering	
Please allow 5-6 weeks lead time for coloured doors	
	117
Single doors	
	187
Double doors	
Please consult your Hörmann dealer for steel garage door styles that are available from stock in colours: Anthracite grey RAL 7016, Jet black RAL 9005, Moss green RAL 6005 and Steel blue RAL 5011	
Coloured window frames for Georgian and Ilkley doors:	
Coloured window frames to match door colour	
Georgian doors (price per window, see note below for the number of windows)	36
Ilkley doors (price per single door)	164
Ilkley doors (price per double door)	326
Please state coloured windows required on order	
Orders received without reference will be supplied with white as standard	
Georgian doors up to 10' wide = 4 windows, 11' to 13' = 6 windows, 14' = 8 windows	
Optional handle sets	
Cast Aluminium silver colour and brass colour	150
Cast Aluminium white and brown	176
Brushed or polished stainless steel	213
Matching lever handles are also available for side doors	P.O.A.

Hörmann Up-and-Over Doors

Canopy & retractable with timber infill

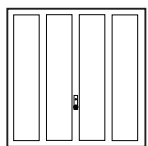
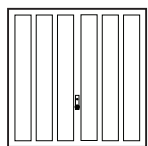

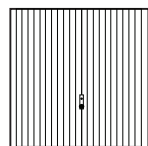
SINGLE DOORS											
Door sizes BR		2005 Measham		2007 Jacobean		2008 Tudor		2014 Rutland		2009 Vertical or Horizontal	
Imperial	Metric	CAN.	RET.	CAN.	RET.	CAN.	RET.	CAN.	RET.	CAN.	RET.
6'6" x 6'6"	1981 x 1981	1214	1255	1463	1504	1463	1504	1463	1504	1669	1710
	1981 x 2134	1214	1255	1463	1504	1463	1504	1463	1504	1669	1710
6'10" x 6'4"	2083 x 1930	1214	1255	1463	1504	1463	1504	1463	1504	1669	1710
	2083 x 1981										
7'0" x 6'4"	2134 x 1930	1214	1255	1463	1504	1463	1504	1463	1504	1669	1710
	2134 x 1981	1214	1255	1463	1504	1463	1504	1463	1504	1669	1710
7'0" x 6'6"	2134 x 2134	1214	1255	1463	1504	1463	1504	1463	1504	1669	1710
	2134 x 2286										
7'3" x 6'4"	2210 x 1930	1262	1303	1532	1573	1532	1573	1532	1573	1730	1771
	2210 x 1981										
7'5" x 6'6"	2261 x 1981	1262	1303	1532	1573	1532	1573	1532	1573	1730	1771
	2261 x 2134	1356	1397	1579	1620	1579	1620	1579	1620	1769	1810
7'6" x 6'4"	2286 x 1930	1262	1303	1532	1573	1532	1573	1532	1573	1730	1771
	2286 x 1981	1262	1303	1532	1573	1532	1573	1532	1573	1730	1771
7'6" x 6'6"	2286 x 2134	1291	1332	1579	1620	1579	1620	1579	1620	1769	1810
	2286 x 2286										
8'0" x 6'6"	2286 x 2438										
7'8" x 6'4"	2337 x 1930	1309	1350	1599	1640	1599	1640	1599	1640	1730	1771
8'0" x 6'4"	2438 x 1930	1332	1373	1617	1658	1617	1658	1617	1658	1829	1870
	2438 x 1981	1332	1373	1617	1658	1617	1658	1617	1658	1829	1870
8'0" x 6'6"	2438 x 2134	1359	1400	1657	1698	1657	1698	1657	1698	1882	1923
	2438 x 2438										
8'6" x 6'6"	2590 x 1981										
	2590 x 2134										
9'0" x 6'6"	2743 x 1981		1608		1864		1864		1864		1990
	2743 x 2134		1608		1864		1864		1864		1990
10'0" x 6'6"	3048 x 1981		1613		1991		1991		1991		2080
	3048 x 2134		1613		1991		1991		1991		2080

DOUBLE DOORS Internal frame sizes BR		2005 Measham		2007 Jacobean		2008 Tudor		2014 Rutland		2009 Vertical or Horizontal	
Imperial	Metric	CAN.	RET.	CAN.	RET.	CAN.	RET.	CAN.	RET.	CAN.	RET.
11'0" x 6'6"	3353 x 1981		2846		3139		3139		3139		3352
	3353 x 2134		2846		3139		3139		3139		3352
12'0" x 6'6"	3658 x 1981		2953		3154		3154		3154		3706
	3658 x 2134		2953		3154		3154		3154		3706
13'0" x 6'6"	3962 x 1981		2964		3402		3402		3402		4143
	3962 x 2134		2964		3402		3402		3402		4143
14'0" x 6'6"	4267 x 1981		2969		3348		3348		3348		3471
	4267 x 2134		2969		3348		3348		3348		3471

Please note: Lead times on all timber garage doors will be 5 to 6 weeks

MATCHING SIDE DOORS Ordering sizes	2005 Measham	2007 Jacobean	2008 Tudor	2014 Rutland	2009 Vertical or Horizontal
875 x 1875	833	963	963	963	974
875 x 2000	833	963	963	963	974
875 x 2125	833	963	963	963	974
1000 x 2000	875	1003	1003	1003	1018
1000 x 2125	875	1003	1003	1003	1018

Please note: Lead times on all timber side garage doors will be 5 to 6 weeks





2109 Mallory Horizontal or Vertical		2013 Caxton		2020 Gatcombe		2114 Shepshed		2019 Garage Light		75mm steel framed doors Recommended structural opening sizes allowing tolerance of 10mm on width & 5mm on height For steel frame options see page 9	
CAN.	RET.	CAN.	RET.	CAN.	RET.	CAN.	RET.	CAN.	RET.	Imperial	Metric
1666	1707	1932	1973	1932	1973	1932	1973	1996	2037	7'0" x 6'8½"	2135 x 2044
1666	1707	1932	1973	1932	1973	1932	1973	1996	2037	7'0" x 7'2¾"	2135 x 2199
1666	1707	1932	1973	1932	1973	1932	1973	1996	2037	7'4" x 6'6½"	2235 x 1994
										7'4" x 6'8½"	2235 x 2044
										7'4" x 7'2¾"	2235 x 2199
1666	1707	1932	1973	1932	1973	1932	1973	1996	2037	7'6" x 6'6½"	2284 x 1994
1666	1707	1932	1973	1932	1973	1932	1973	1996	2037	7'6" x 6'8½"	2284 x 2044
1666	1707	1932	1973	1932	1973	1932	1973	1996	2037	7'6" x 7'2¾"	2284 x 2199
										7'6" x 7'8½"	2284 x 2350
1730	1771	1994	2035	1994	2035	1994	2035	2083	2124	7'9¼" x 6'6½"	2365 x 1994
										7'9¼" x 6'8½"	2365 x 2044
										7'9¼" x 7'2¾"	2365 x 2199
1730	1771	1994	2035	1994	2035	1994	2035	2083	2124	7'11" x 6'8½"	2411 x 2044
1794	1835	2025	2066	2025	2066	2025	2066	2136	2177	7'11" x 7'2¾"	2411 x 2199
1730	1771	1994	2035	1994	2035	1994	2035	2083	2124	8'0" x 6'6½"	2436 x 1994
1730	1771	1994	2035	1994	2035	1994	2035	2083	2124	8'0" x 6'8½"	2436 x 2044
1794	1835	2025	2066	2025	2066	2025	2066	2180	2221	8'0" x 7'2¾"	2436 x 2199
										8'0" x 7'8½"	2436 x 2350
										8'0" x 8'2¾"	2436 x 2503
1901	1942	2184	2225	2184	2225	2184	2225	2336	2377	8'2" x 6'6½"	2489 x 1994
1901	1942	2184	2225	2184	2225	2184	2225	2336	2377	8'6" x 6'6½"	2589 x 1994
1901	1942	2184	2225	2184	2225	2184	2225	2336	2377	8'6" x 6'8½"	2589 x 2044
1901	1942	2184	2225	2184	2225	2184	2225	2336	2377	8'6" x 7'2¾"	2589 x 2199
										8'6" x 8'2¾"	2589 x 2503
										9'0" x 6'8½"	2741 x 2044
										9'0" x 7'2¾"	2741 x 2199
	2186		2494		2494		2494		2562	9'6" x 6'8½"	2894 x 2044
	2186		2494		2494		2494		2562	9'6" x 7'2¾"	2894 x 2199
	2384		2655		2655		2655		2849	10'6" x 6'8½"	3199 x 2044
	2384		2655		2655		2655		2849	10'6" x 7'2¾"	3199 x 2199
2109 Mallory		2013 Caxton		2020 Gatcombe		2114 Shepshed		2019 Garage Light		Imperial	Metric
CAN.	RET.	CAN.	RET.	CAN.	RET.	CAN.	RET.	CAN.	RET.		
	3527		3724		3724		3724		4145	11'6" x 6'8½"	3504 x 2044
	3527		3724		3724		3724		4145	11'6" x 7'2¾"	3504 x 2199
	3825		4048		4048		4048		4559	12'6" x 6'8½"	3809 x 2044
	3825		4048		4048		4048		4559	12'6" x 7'2¾"	3809 x 2199
	4150		4424		4424		4424		5133	13'6" x 6'8½"	4114 x 2044
	4150		4424		4424		4424		5133	13'6" x 7'2¾"	4114 x 2199
	4031		4303		4303		4303		4864	14'6" x 6'8½"	4419 x 2044
	4031		4303		4303		4303		4864	14'6" x 7'2¾"	4419 x 2199
2109 Mallory		2013 Caxton		2020 Gatcombe		2114 Shepshed		2019 Garage Light			
CAN.	RET.	CAN.	RET.	CAN.	RET.	CAN.	RET.	CAN.	RET.		
	1098		1161		1130		1130		1294		
	1098		1161		1130		1130		1294		
	1098		1161		1130		1130		1294		
	1143		1205		1173		1173		1335		
	1143		1205		1173		1173		1335		

Hörmann Up-and-Over Doors

Canopy & retractable with timber infill

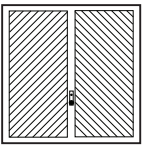
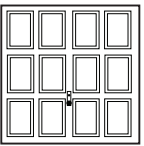

SINGLE DOORS										75mm steel framed doors Recommended structural opening sizes allowing tolerance of 10mm on width & 5mm on height For steel frame options see page 9	
Door sizes BR		2119 Leicester		2100 Chevron		2121 Chesterfield		2122 Middleton			
Imperial	Metric	CAN.	RET.	CAN.	RET.	CAN.	RET.	CAN.	RET.	Imperial	Metric
6'6" x 6'6"	1981 x 1981		2300	2062	2103		2628		2606	7'0" x 6'8½"	2135 x 2044
	7'0"		2300	2062	2103		2628		2606	7'0" x 7'2¾"	2135 x 2199
6'10" x 6'4"	2083 x 1930		2300	2062	2103		2628		2606	7'4" x 6'6½"	2235 x 1994
	6'6"									7'4" x 6'8½"	2235 x 2044
	7'0"									7'4" x 7'2¾"	2235 x 2199
7'0" x 6'4"	2134 x 1930		2317	2062	2103		2628		2606	7'6" x 6'6½"	2284 x 1994
	6'6"		2317	2062	2103		2628		2606	7'6" x 6'8½"	2284 x 2044
	7'0"		2317	2062	2103		2646		2636	7'6" x 7'2¾"	2284 x 2199
	7'6"									7'6" x 7'8½"	2284 x 2350
7'3" x 6'4"	2134 x 1930		2527	2154	2195		2821		2812	7'9¼" x 6'6½"	2365 x 1994
	6'6"									7'9¼" x 6'8½"	2365 x 2044
	7'0"									7'9¼" x 7'2¾"	2365 x 2199
7'5" x 6'6"	2261 x 1981		2538	2154	2195		2826		2812	7'11" x 6'8½"	2411 x 2044
	7'0"		2636	2213	2254		2838		2826	7'11" x 7'2¾"	2411 x 2199
7'6" x 6'4"	2286 x 1930		2536	2154	2195		2826		2812	8'0" x 6'6½"	2436 x 1994
	6'6"		2536	2154	2195		2826		2812	8'0" x 6'8½"	2436 x 2044
	7'0"		2636	2213	2254		2854		2838	8'0" x 7'2¾"	2436 x 2199
	7'6"									8'0" x 7'8½"	2436 x 2350
	8'0"									8'2" x 6'6½"	2436 x 2503
7'8" x 6'4"	2337 x 1930		2704	2352	2393					8'6" x 6'6½"	2489 x 1994
8'0" x 6'4"	2438 x 1930		2715	2352	2393					8'6" x 6'8½"	2589 x 1994
	6'6"		2715	2352	2393					8'6" x 7'2¾"	2589 x 2044
	7'0"		2774	2389	2430					8'6" x 7'8½"	2589 x 2199
	8'0"									8'6" x 8'2¾"	2589 x 2503
8'6" x 6'6"	2590 x 1981									9'0" x 6'8½"	2741 x 2044
	7'0"									9'0" x 7'2¾"	2741 x 2199
9'0" x 6'6"	2743 x 1981		2845		2587					9'6" x 6'8½"	2894 x 2044
	7'0"		2845		2587					9'6" x 7'2¾"	2894 x 2199
10'0" x 6'6"	3048 x 1981		3204		3012					10'6" x 6'8½"	3199 x 2044
	7'0"		3204		3012					10'6" x 7'2¾"	3199 x 2199

DOUBLE DOORS Internal Frame Sizes BR		2119 Leicester		2100 Chevron		Style Not Available		Style Not Available			
BR	RET.	CAN.	RET.	CAN.	RET.	CAN.	RET.	CAN.	RET.	Imperial	Metric
11'0" x 6'6"	3353 x 1981		4465		4273					11'6" x 6'8½"	3504 x 2044
	7'0"		4465		4273					11'6" x 7'2¾"	3504 x 2199
12'0" x 6'6"	3658 x 1981		4774		4352					12'6" x 6'8½"	3809 x 2044
	7'0"		4774		4352					12'6" x 7'2¾"	3809 x 2199
13'0" x 6'6"	3962 x 1981		5225		4424					13'6" x 6'8½"	4114 x 2044
	7'0"		5225		4424					13'6" x 7'2¾"	4114 x 2199
14'0" x 6'6"	4267 x 1981		5097		4303					14'6" x 6'8½"	4419 x 2044
	7'0"		5097		4303					14'6" x 7'2¾"	4419 x 2199

Please note: Lead times on all timber garage doors will be 5 to 6 weeks

MATCHING SIDE DOORS Ordering Sizes	2119 Leicester	2100 Chevron	2121 Chesterfield	2122 Middleton		
875 x 1875	991	963	963	991		
875 x 2000	991	963	963	991		
875 x 2125	991	963	963	991		
1000 x 2000	1018	1003	1003	1018		
1000 x 2125	1018	1003	1003	1018		

Please note: Lead times on all timber side garage doors will be 5 to 6 weeks



Our timber garage doors are constructed as an infill to fit into the Open-for-Infill Up-and-Over door frame, this gives the doors their rigid and durable construction.

The styles Measham, Jacobean, Tudor and Rutland are cedar facings glued and fixed to exterior quality plywood.

The solid cedar doors are 12mm tongue and groove boards constructed as an infill.

Cedar is organically grown with natural colour and grain variations; this is a feature of cedar.

We make every effort to harmonise the effect where possible, by hand matching the component parts used in construction.

Please note a uniform overall grain pattern cannot be guaranteed.

Protection (Basecoat)

All our timber doors are supplied with a dip immersion coat of Remmers Induline GW306 base stain primer 006 Light Oak; this coating is for temporary protection only.

If purchased in this temporary finish, please ensure that a full specification of finishing coats are applied immediately before or after installation to all exposed surfaces - inside as well as outside - with a Remmers or similar finishing coat system.

A fully finished option is available, please see options below.

For further choice of exciting door designs, traditional or contemporary in Nordic Pine and Hemlock, with a vast range of sizes, ask your garage door specialist about the N80 Up-and-Over garage doors available to special order.

Optional extras for timber doors	Price
75mm Steel fixing frame for either canopy or retractable geared single doors, factory fitted Terra brown RAL 8028 as standard	123
75mm Steel fixing frame for DOUBLE retractable geared doors Terra brown RAL 8028 as standard when ordered with the door	194
60mm Steel fixing frame for canopy geared doors only, factory fitted Terra brown RAL 8028 as standard	127
Please note: Factory fitted 8' high frame not available	
Retractable plus gear for retractable doors up to 7'6" wide giving extra drive through width Surcharge on retractable price	64
4 point locking kit for extra security, factory fit with door order or retrofit	58
Window options for 2019 Garage Light door - Crystal or clear glazing and can be plain or with square or diamond simulated leading	Incl.

Fully finished option

This is available as a factory process giving a 5 year erosion protection

The product used is Remmers and is available in the following stain colours:

Mahogany, Walnut, Dark Oak, Medium Oak, Light Oak, Teak, Rosewood and Golden Oak

For south facing situations exposed to strong sunlight, the dark colours are NOT recommended as they can store excessive heat and dry out

	Stain finish	Traffic white RAL 9016/Ebony	RAL to choose
Door sizes up to 8'0" x 7'0"	125	215	286
Door sizes up to 14'0" x 7'0"	286	386	708
Side Doors	93	194	242

Optional handle sets

Cast Aluminium silver colour and brass colour	150
Cast Aluminium white and brown	176
Brushed or polished stainless steel	213
Matching lever handles are also available for side doors	P.O.A.



Product description

Views

(The illustrations correspond to size 2500 x 2125 mm. Deviations may occur with other sizes.)

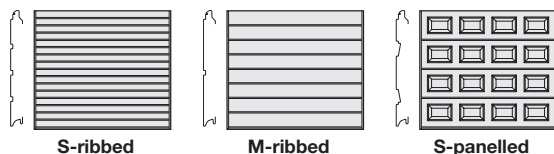

General

Sectional garage doors for private purposes. Prepared for Hörmann garage door operators, 10 door cycles per day in accordance with the guarantee conditions.

Door leaf

With finger trap protection on outside and inside.

Door sections made of steel sections, *Woodgrain*-embossed, made of hot-galvanized sheet steel.

Versions:

Any door height divided in even sections.

- S-ribbed: horizontal increments evenly spaced in height
- M-ribbed: horizontal increments evenly spaced in height
- S-panelled: panel arrangement evenly spaced in width

Bottom door section as standard with concealed ventilation slots (ventilation cross section 58 cm²/m) and bottom seal.

Note on door leaf reinforcement:

All doors from LZ > 4000 mm are equipped at the factory with the door leaf reinforcement set.

Frame

- **Frame** with trap guard, made of hot-galvanized sheet steel, *Woodgrain*-textured, with side seal and plastic frame shoe. Frame with polyester-primer coating in Traffic white, based on RAL 9016.
- **Fascia panel** – *Woodgrain*-embossed, with seal to make up for insufficient headroom up to 100 mm.
- **Frame covering** (optional for a surcharge), required for fitting in the reveal, Traffic white based on RAL 9016, single-skinned, *Woodgrain*-embossed.

Counterbalance

- Tension spring technology: with lateral integral double tension springs with 2 cables on each side
 - up to door width 3250 mm and door height 2625 mm,
 - up to door width 3500 mm and door height 2375 mm,
 - up to door width 4000 mm and door height 2250 mm
- Torsion spring assembly: Torsion spring assembly with cable drums and approved spring safety device as well as integral lateral cables
 - from door width 3251 mm and door height 2626 mm,
 - from door width 3501 mm and door height 2376 mm,
 - from door width 4001 mm and door height 2251 mm

Tension springs and torsion springs are galvanized.

Fittings and closing devices

As standard without door handle set and lock. The door handle sets to be ordered separately are supplied including a template for an on-site lock knock-out. A factory lock knock-out will result in a longer delivery time and must be ordered explicitly.



If a sectional door without door handle set and lock is equipped with an operator, an emergency release is required if there is no second entrance!

Hörmann Sectional Doors

LTE 42 – single-skinned doors with steel sections

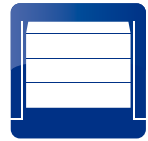
Single doors with Z track tension springs giving low headroom as standard

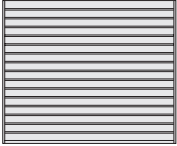

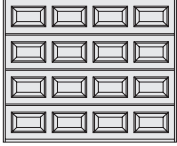
SINGLE DOORS								No. of panels
Door sizes BR		S-ribbed Woodgrain		M-ribbed Woodgrain		S-panelled Woodgrain		
Imperial	Metric	Outside White	Outside Colour	Outside White	Outside Colour	Outside White	Outside Colour	
6'10" x 6'2"	2080 x 1875	838	1002	838	1002	939	1103	4
6'10"	2080 x 2080	877	1059	877	1059	975	1157	4
7'0" x 6'6"	2134 x 2000	855	1035	855	1035	956	1136	4
7'0"	2134 x 2125	877	1068	877	1068	975	1166	4
7'6" x 6'6"	2286 x 2000	855	1048	855	1048	956	1149	4
7'0"	2286 x 2125	877	1082	877	1082	975	1180	4
7'4"	2286 x 2250	923	1140	923	1140	1014	1231	4
7'9"	2286 x 2375	1069	1298	1069	1298	1170	1399	4
8'2"	2286 x 2500	1068	1309	1068	1309	1167	1408	4
8'0" x 6'6"	2438 x 2000	891	1096	891	1096	992	1197	4
7'0"	2438 x 2125	921	1139	921	1139	1010	1228	4
7'4"	2438 x 2250	968	1199	968	1199	1052	1283	4
7'9"	2438 x 2375	1112	1356	1112	1356	1204	1448	4
8'2"	2438 x 2500	1110	1366	1110	1366	1204	1460	4
8'6" x 6'6"	2591 x 2000	891	1109	891	1109	992	1210	4
7'0"	2591 x 2125	921	1153	921	1153	1010	1242	4
9'0" x 6'6"	2740 x 2000	1003	1234	1003	1234	1150	1381	4
7'0"	2740 x 2125	1034	1279	1034	1279	1172	1417	4
9'6" x 6'6"	2896 x 2000	1036	1280	1036	1280	1207	1451	5
7'0"	2896 x 2125	1075	1334	1075	1334	1226	1485	5
10'0" x 6'6"	3048 x 2000	1036	1293	1036	1293	1207	1464	5
7'0"	3048 x 2125	1075	1348	1075	1348	1226	1499	5

For information on outside colour, see page 17

Double doors with N track springs (see shaded area of grid). For low headroom see bottom of page 17

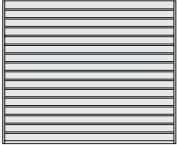
DOUBLE DOORS							
Door sizes BR		S-ribbed Woodgrain					
Imperial	Metric	Outside White	Outside Colour				
11'0" x 6'6"	3353 x 2000	1445	1727				
7'0"	3353 x 2125	1497	1797				
12'0" x 6'6"	3658 x 2000	1599	1907				
7'0"	3658 x 2125	1665	1992				
13'0" x 6'6"	3962 x 2000	1633	1966				
7'0"	3962 x 2125	1698	2052				
14'0" x 6'6"	4267 x 2000	1770	2129				
7'0"	4267 x 2125	1865	2246				
14'6" x 6'6"	4420 x 2000	1808	2180				
7'0"	4420 x 2125	1906	2301				
15'0" x 6'6"	4572 x 2000	1820	2205				
7'0"	4572 x 2125	1912	2321				
15'6" x 6'6"	4725 x 2000	1874	2271				
7'0"	4725 x 2125	1968	2390				
16'0" x 6'6"	4877 x 2000	1872	2282				
7'0"	4877 x 2125	1968	2404				

For door width and glazing configuration - please refer to the 01-20 A

Sectional doors LPU 42 – steel

TÜV-approved break-in resistance in accordance with the TTZ directive for LPU 42* with operator



Product description

* Not for versions with glazing

Views

(The illustrations correspond to size 2500 × 2125 mm. Deviations may occur with other sizes.)

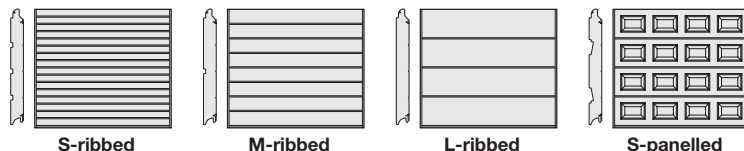

General

Sectional garage doors for private purposes. Prepared for Hörmann garage door operators, 10 door cycles per day in accordance with the guarantee conditions.

Door leaf

With finger trap protection on outside and inside.

Door sections made of double-skinned steel sections, 42 mm thick, made of hot-galvanized sheet steel, PU-foamed.

- S-ribbed *Woodgrain*-embossed on exterior
- M-ribbed *Woodgrain*-embossed, *Sandgrain*, *Silkgrain* or *Decograin* on exterior
- L-ribbed *Woodgrain*-embossed, *Sandgrain*, *Planar*, *Silkgrain*, *Decograin* or *Duragrain* on exterior
- S-panelled *Woodgrain*-embossed or *Decograin* on exterior

Thermal insulation value:

- Section 42 mm $U = 0.5 \text{ W}/(\text{m}^2\cdot\text{K})$
- Fitted door 42 mm (without ThermoFrame)* $U = 1.4 \text{ W}/(\text{m}^2\cdot\text{K})$
- Fitted door 42 mm (with ThermoFrame)* $U = 1.2 \text{ W}/(\text{m}^2\cdot\text{K})$

* Without glazing, door size 5000 × 2250 mm

Versions:

Any door height divided in even sections (except intermediate heights).

- S- or M-ribbed: horizontal increments evenly spaced in height
- L-ribbed
- S-panelled: panel arrangement evenly spaced in width

Bottom door section with bottom seal as standard.

Note on door leaf reinforcement:

Solar radiation may result in deflection of the door elements and foam break. To reduce the possibility of section deflection caused by sun exposure, all doors from LZ > 5000 mm are equipped at the factory with the door leaf reinforcement set.

From LZ > 4500 mm, the following colours and decors are equipped at the factory with the door leaf reinforcement set.

- RAL colours

RAL 3007	Black red	RAL 6022	Olive drab
RAL 5003	Sapphire blue	RAL 7016	Anthracite grey
RAL 5004	Black blue	RAL 7021	Black grey
RAL 5011	Steel blue	RAL 7043	Traffic grey
RAL 5013	Cobalt blue	RAL 8014	Sepia brown
RAL 5020	Ocean blue	RAL 8016	Mahogany brown
RAL 5022	Night blue	RAL 8017	Chocolate brown
RAL 6004	Blue green	RAL 8019	Grey brown
RAL 6005	Moss green	RAL 8022	Black brown
RAL 6007	Bottle green	RAL 8028	Terra brown
RAL 6008	Brown green	RAL 9004	Signal black
RAL 6009	Fir green	RAL 9005	Jet black
RAL 6012	Black green	RAL 9011	Graphite black
RAL 6015	Black olive	RAL 9017	Traffic black
- Colour CH 703
- Planar CH 7016 Matt deluxe Anthracite grey, CH 8028 Matt deluxe Terra brown and CH 703 Matt deluxe Anthracite metallic.
- Decograin decors Dark Oak, Night Oak, Rosewood and Titan Metallic CH 703
- Duragrain decors Sapeli, Terra Walnut, Mocca, Grigio scuro, Rusty Steel, Burned Oak, Cherry, Rusty Oak, Noce Sorrento Balsamico

Colours and decors that have not been listed may be ordered with the door leaf reinforcement set.

In case of any doubt, we recommend ordering the reinforcement as an option for doors under thermal loads not equipped with a door leaf reinforcement at the factory.

Door leaf reinforcements limit section deflection, but do not prevent it completely.

The use of a SupraMatic is recommended for doors with operator and door leaf reinforcements.

Frame

- **Frame** with trap guard, made of hot-galvanized sheet steel, *Woodgrain*-embossed, with side seal and plastic frame shoe. Standard version: Frame with polyester-primer coating in Traffic white, based on RAL 9016; galvanized tracks, suspensions and connection rail. Premium version: Frame, tracks, suspensions and connection rail in Grey white based on RAL 9002.
- **Fascia panel, single-skinned, with seal to make up for insufficient headroom up to 100 mm**
 - in *Woodgrain*-embossed with *Woodgrain* doors.
 - in smooth for *Sandgrain*, *Planar*, *Silkgrain* and *Decograin*. Fascia panel in door colour for doors in RAL 9016, Color, Color Matt deluxe, RAL to choose and colour CH 703 Anthracite metallic.
 - in *Decograin* (with plastic film coating, for possible decors see page 13).
 - in *Duragrain* as standard in *Woodgrain* RAL 9016 (optionally available in a decor matching the colour).
- **Frame covering, single-skinned** (optional for a surcharge) required for fitting in the reveal
 - in *Woodgrain*-embossed, *Sandgrain*, *Planar*, *Silkgrain*, *Decograin* or *Duragrain*

For possible surface coating (colours / decors), see product description on page 13. Please state desired colour / decor on order!

Counterbalance

- Tension spring technology: with lateral integral double tension springs with 2 cables on each side
 - up to door width 3250 mm and door height 2625 mm,
 - up to door width 3500 mm and door height 2375 mm,
 - up to door width 4000 mm and door height 2250 mm
 - Torsion spring assembly: Torsion spring assembly with cable drums and approved spring safety device as well as integral lateral cables
 - from door width 3251 mm and door height 2626 mm,
 - from door width 3501 mm and door height 2376 mm,
 - from door width 4001 mm and door height 2251 mm
- Tension springs and torsion springs are galvanized.



Product description

Fittings and closing devices

As standard without door handle set and lock. The door handle sets to be ordered separately are supplied including a template for an on-site lock knock-out.

A factory lock knock-out will result in a longer delivery time and must be ordered explicitly.

If a sectional door without door handle set and lock is equipped with an operator, an emergency release is required if there is no second entrance!

Fitting parts

As standard, the fitting parts are galvanized.

Premium version

The following components are supplied in RAL 9002:

- Door leaf fittings
- Side frames
- Horizontal tracks incl. connection rail and track arches
- Defined accessory parts

Surface coating of door leaf

Woodgrain and Silkgrain version with polyester-primer coating on both sides

Interior:

- Grey white, based on RAL 9002

Exterior:

- Traffic white as standard, based on RAL 9016
- Color, preferred colours based on the RAL CLASSIC colour chart

RAL 1015 Light ivory	RAL 7035 Light grey
RAL 3003 Ruby red	RAL 7040 Window grey
RAL 5011 Steel blue	RAL 8001 Ochre brown
RAL 5014 Pigeon blue	RAL 8003 Clay brown
RAL 6005 Moss green	RAL 8028 Terra brown
RAL 6009 Fir green	RAL 9006 White aluminium
RAL 7016 Anthracite grey	RAL 9007 Grey aluminium
RAL 7030 Stone grey	
- RAL to choose*, based on the RAL CLASSIC colour chart
- Hörmann colour CH 703 (Anthracite metallic)
- Special colours on request (other colour systems, such as NCS or DB* colours and colour 8077)

Not available: RAL colours 4006, 4007 and 9021 as well as pearl-effect colours and fluorescent colours.

Sandgrain version with polyester-primer coating on both sides

Interior:

- Grey white, based on RAL 9002

Exterior:

- Traffic white as standard, based on RAL 9016
- Color, preferred colours based on the RAL CLASSIC colour chart

RAL 7016 Anthracite grey
RAL 8028 Terra brown
RAL 9006 White aluminium

Other colours and RAL to choose are not possible!

Planar version with polyester-primer coating on both sides

Interior:

- Grey white, based on RAL 9002

Exterior:

- Standard Traffic white, in CH 9016 Matt deluxe
- Color Matt deluxe based on the RAL CLASSIC colour chart

CH 9006 Matt deluxe	White aluminium
CH 9007 Matt deluxe	Grey aluminium
CH 7016 Matt deluxe	Anthracite grey
CH 8028 Matt deluxe	Terra brown
- CH 703 Matt deluxe Anthracite metallic

Other colours and RAL to choose are not possible!

Notes on polyester-primer coating on both sides

If double-skinned steel doors have sun exposure, avoid dark colours. Section distortion can impair door function. In case of any doubt, we recommend to choose the optional door leaf reinforcements for wider doors exposed to the sun that are not reinforced as standard

Deviations in colour are to be expected due to the use of different base materials, such as aluminium and steel, and textures, as well as due to varying production processes and locations.

Despite the use of state-of-the-art colour coating systems, colour deviations cannot be ruled out, specially in metallic colours such as RAL 9006 and RAL 9007.

Version with Duragrain coating on exterior

Interior:

- Polyester-primer coating, Grey white, based on RAL 9002

Exterior:

- Coating in Duragrain decor with high-strength coating, authentic surface finish look.

Bamboo	Rusty Oak
Beige	Rusty Steel
Concrete	Sapele
Burned Oak	Sheffield
Cherry	Teak
Pine	Weathered Look
Grigio	Colonial Walnut
Grigio scuro	Terra Walnut
Mocca	White brushed
Nature Oak	White Oak
Noce Sorrento Balsamico	White Oiled Oak
Noce Sorrento Nature	Whitewashed Oak

Colours matching Duragrain

The frame covering and glazing frames are coated in a colour matching the decor.

Decograin version with plastic film coating on the exterior

Interior:

- Polyester-primer coating, Grey white, based on RAL 9002

Exterior:

- Coated with timber design plastic film with embossed timber structure for authentic timber character.

Golden Oak:	Medium-brown, golden yellow oak design
Dark Oak:	Walnut-coloured oak design
Night Oak:	Dark brown oak design
Rosewood:	Mahogany-coloured timber design
Winchester Oak:	Natural-coloured knotty oak design

- Coated with plastic film in **Titan Metallic CH 703** (only for M- or L-ribbed sectional doors)

Colours matched to Decograin



The glazing frames are coated in a colour matching the decor.

Hörmann Sectional Doors

LPU 42 – single-skinned doors with steel sections

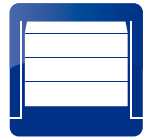

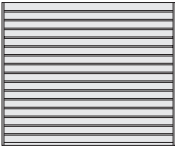
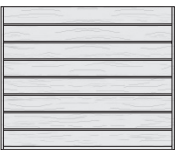
Single doors with Z track tension springs giving low headroom as standard



SINGLE DOORS							
Door sizes BR		S-ribbed Woodgrain		M-ribbed Woodgrain		M-ribbed Sandgrain	
Imperial	Metric	Outside White	Outside Colour*	Outside White	Outside Colour*	Outside White	Outside Colour*
6'10" x 6'2"	2080 x 1875	975	1139	975	1139	1036	1200
6'6"	2080 x 2080	1018	1193	1018	1193	1085	1260
6'10"	2080 x 2080	1055	1237	1055	1237	1128	1310
7'0" x 6'6"	2134 x 2000	1053	1233	1053	1233	1085	1265
7'0"	2134 x 2125	1090	1281	1090	1281	1128	1319
7'6" x 6'6"	2286 x 2000	1053	1246	1053	1246	1085	1278
7'0"	2286 x 2125	1090	1295	1090	1295	1128	1333
7'4"	2286 x 2250	1104	1321	1104	1321	1179	1396
7'9"	2286 x 2375	1191	1420	1191	1420	1230	1459
8'2"	2286 x 2500	1189	1430	1189	1430	1279	1520
8'0" x 6'6"	2438 x 2000	1106	1311	1106	1311	1144	1349
7'0"	2438 x 2125	1150	1368	1150	1368	1194	1412
7'4"	2438 x 2250	1158	1389	1158	1389	1232	1463
7'9"	2438 x 2375	1245	1489	1245	1489	1285	1529
8'2"	2438 x 2500	1243	1499	1243	1499	1343	1599
8'6" x 6'6"	2591 x 2000	1106	1324	1106	1324	1144	1362
7'0"	2591 x 2125	1150	1382	1150	1382	1194	1426
9'0" x 6'6"	2740 x 2000	1197	1428	1197	1428	1246	1477
7'0"	2740 x 2125	1237	1482	1237	1482	1296	1541
9'6" x 6'6"	2896 x 2000	1249	1493	1249	1493	1309	1553
7'0"	2896 x 2125	1299	1558	1299	1558	1363	1622
10'0" x 6'6"	3048 x 2000	1208	1465	1208	1465	1309	1566
7'0"	3048 x 2125	1250	1523	1250	1523	1363	1636

* For information on outside colour, see page 13

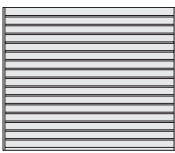
Double doors with N track springs (see shaded area of grid). For low headroom see bottom of page 17

DOUBLE DOORS							
Door sizes BR		S-ribbed Woodgrain		M-ribbed Woodgrain		M-ribbed Sandgrain	
Imperial	Metric	Outside White	Outside Colour*	Outside White	Outside Colour*	Outside White	Outside Colour*
11'0" x 6'6"	3353 x 2000	1420	1702	1420	1702	1551	1833
7'0"	3353 x 2125	1477	1777	1477	1777	1612	1912
12'0" x 6'6"	3658 x 2000	1667	1975	1667	1975	1742	2050
7'0"	3658 x 2125	1730	2057	1730	2057	1812	2139
13'0" x 6'6"	3962 x 2000	1727	2060	1727	2060	1794	2127
7'0"	3962 x 2125	1793	2147	1793	2147	1858	2212
14'0" x 6'6"	4267 x 2000	1790	2149	1790	2149	1843	2202
7'0"	4267 x 2125	1862	2243	1862	2243	1917	2298
14'6" x 6'6"	4420 x 2000	1850	2222	1850	2222	1889	2261
7'0"	4420 x 2125	1923	2318	1923	2318	1966	2361
15'0" x 6'6"	4572 x 2000	1883	2268	1883	2268	1903	2288
7'0"	4572 x 2125	1957	2366	1957	2366	1983	2392
15'6" x 6'6"	4725 x 2000	1963	2360	1963	2360	1936	2333
7'0"	4725 x 2125	2040	2462	2040	2462	2015	2437
16'0" x 6'6"	4877 x 2000	1963	2373	1963	2373	1972	2382
7'0"	4877 x 2125	2040	2476	2040	2476	2050	2486



Intermediate sizes are available, Please see your dealer for more details

Hörmann Sectional Doors

LPU 42 – single-skinned doors with steel sections



Single doors with Z track tension springs giving low headroom as standard

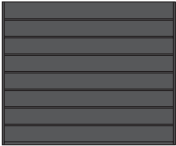

SINGLE DOORS							
Door sizes BR		M-ribbed Silkgrain		M-ribbed Decograin		M-ribbed Titan Metallic CH703	
Imperial	Metric	Outside White	Outside Colour*	Outside Timber Design*		Outside Titan Metallic CH703*	
6'10" x 6'2"	2080 x 1875	1189	1353	1306		1306	
	6'6"	2080 x 2000	1246	1421	1369		1369
	6'10"	2080 x 2080	1295	1477	1422		1422
7'0" x 6'6"	2134 x 2000	1246	1426	1369		1369	
	7'0"	2134 x 2125	1295	1486	1422		1422
7'6" x 6'6"	2286 x 2000	1246	1439	1369		1369	
	7'0"	2286 x 2125	1295	1500	1422		1422
	7'4"	2286 x 2250	1355	1572	1489		1489
	7'9"	2286 x 2375	1415	1644	1555		1555
8'0" x 6'6"	2438 x 2000	1470	1711	1616		1616	
	7'0"	2438 x 2125	1374	1592	1512		1512
	7'4"	2438 x 2250	1414	1645	1556		1556
	7'9"	2438 x 2375	1482	1726	1631		1631
8'6" x 6'6"	2438 x 2500	1549	1805	1706		1706	
	7'0"	2591 x 2000	1318	1536	1450		1450
	7'0"	2591 x 2125	1374	1606	1512		1512
	9'0" x 6'6"	2740 x 2000	1443	1674	1592		1592
9'6" x 6'6"	2740 x 2125	1499	1744	1654		1654	
	2896 x 2000	1518	1762	1677		1677	
10'0" x 6'6"	2896 x 2125	1578	1837	1744		1744	
	3048 x 2000	1518	1775	1677		1677	
10'0" x 7'0"	3048 x 2125	1578	1851	1744		1744	

* For information on outside colour, see page 13

Double doors with N track springs (see shaded area of grid). For low headroom see bottom of page 17

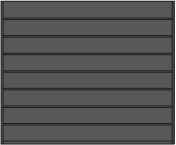
DOUBLE DOORS							
Door sizes BR		M-ribbed Silkgrain		M-ribbed Decograin		M-ribbed Titan Metallic CH703	
Imperial	Metric	Outside White	Outside Colour*	Outside Timber Design*		Outside Titan Metallic CH703*	
11'0" x 6'6"	3353 x 2000	1811	2093	2009		2009	
	7'0"	3353 x 2125	1883	2183	2089		2089
12'0" x 6'6"	3658 x 2000	2041	2349	2269		2269	
	7'0"	3658 x 2125	2121	2448	2358		2358
13'0" x 6'6"	3962 x 2000	2102	2435	2338		2338	
	7'0"	3962 x 2125	2181	2535	2426		2426
14'0" x 6'6"	4267 x 2000	2165	2524	2409		2409	
	7'0"	4267 x 2125	2252	2633	2507		2507
14'6" x 6'6"	4420 x 2000	2219	2591	2471		2471	
	7'0"	4420 x 2125	2309	2704	2572		2572
15'0" x 6'6"	4572 x 2000	2236	2621	2490		2490	
	7'0"	4572 x 2125	2330	2739	2595		2595
15'6" x 6'6"	4725 x 2000	2280	2677	2539		2539	
	7'0"	4725 x 2125	2368	2790	2638		2638
16'0" x 6'6"	4877 x 2000	2318	2728	2583		2583	
	7'0"	4877 x 2125	2412	2848	2687		2687





Intermediate sizes are available, Please see your dealer for more details

Hörmann Sectional Doors

LPU 42 – double-skinned doors with steel sections – 42mm

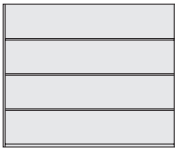

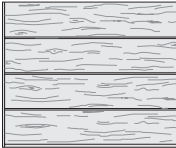

Single doors with Z track tension springs giving low headroom as standard



SINGLE DOORS							
Door sizes BR		L-ribbed Sandgrain		L-ribbed Silkgrain		L-ribbed Decograin	L-ribbed Titan Metallic CH 703
Imperial	Metric	Outside White	Outside Colour*	Outside White	Outside Colour*	Outside Timber Design*	Outside Titan Metallic CH 703*
6'10" x 6'2"	2080 x 1875	1226	1390	1358	1522	1489	1489
6'6"	2080 x 2000	1258	1433	1394	1569	1527	1527
6'10"	2080 x 2080	1277	1459	1411	1593	1545	1545
7'0" x 6'6"	2134 x 2000	1258	1438	1394	1574	1527	1527
7'0"	2134 x 2125	1277	1468	1411	1602	1545	1545
7'6" x 6'6"	2286 x 2000	1258	1451	1394	1587	1527	1527
7'0"	2286 x 2125	1277	1482	1411	1616	1545	1545
7'4"	2286 x 2250	1330	1547	1473	1690	1613	1613
7'9"	2286 x 2375	1338	1567	1480	1709	1620	1620
8'2"	2286 x 2500	1375	1616	1517	1758	1661	1661
8'0" x 6'6"	2438 x 2000	1329	1534	1471	1676	1614	1614
7'0"	2438 x 2125	1353	1571	1500	1718	1646	1646
7'4"	2438 x 2250	1419	1650	1573	1804	1726	1726
7'9"	2438 x 2375	1457	1701	1615	1859	1772	1772
8'2"	2438 x 2500	1499	1755	1659	1915	1820	1820
8'6" x 6'6"	2591 x 2000	1329	1547	1471	1689	1614	1614
7'0"	2591 x 2125	1353	1585	1500	1732	1646	1646
9'0" x 6'6"	2740 x 2000	1456	1687	1616	1847	1777	1777
7'0"	2740 x 2125	1476	1721	1639	1884	1802	1802
9'6" x 6'6"	2896 x 2000	1532	1776	1705	1949	1877	1877
7'0"	2896 x 2125	1556	1815	1731	1990	1905	1905
10'0" x 6'6"	3048 x 2000	1532	1789	1705	1962	1877	1877
7'0"	3048 x 2125	1556	1829	1731	2004	1905	1905

* For information on outside colour, see page 13

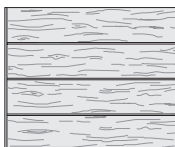
Double doors with N track springs (see shaded area of grid). For low headroom see bottom of page 17

DOUBLE DOORS							
Door sizes BR		L-ribbed Sandgrain		L-ribbed Silkgrain		L-ribbed Decograin	L-ribbed Titan Metallic CH 703
Imperial	Metric	Outside White	Outside Colour*	Outside White	Outside Colour*	Outside Timber Design*	Outside Titan Metallic CH 703*
11'0" x 6'6"	3353 x 2000	1811	2093	2023	2305	2235	2235
7'0"	3353 x 2125	1839	2139	2055	2355	2269	2269
12'0" x 6'6"	3658 x 2000	2040	2348	2286	2594	2530	2530
7'0"	3658 x 2125	2076	2403	2327	2654	2576	2576
13'0" x 6'6"	3962 x 2000	2101	2434	2358	2691	2611	2611
7'0"	3962 x 2125	2134	2488	2391	2745	2648	2648
14'0" x 6'6"	4267 x 2000	2163	2522	2430	2789	2692	2692
7'0"	4267 x 2125	2200	2581	2469	2850	2735	2735
14'6" x 6'6"	4420 x 2000	2223	2595	2496	2868	2767	2767
7'0"	4420 x 2125	2260	2655	2535	2930	2810	2810
15'0" x 6'6"	4572 x 2000	2247	2632	2522	2907	2796	2796
7'0"	4572 x 2125	2284	2693	2564	2973	2842	2842
15'6" x 6'6"	4725 x 2000	2285	2682	2569	2966	2849	2849
7'0"	4725 x 2125	2326	2748	2614	3036	2898	2898
16'0" x 6'6"	4877 x 2000	2328	2738	2614	3024	2899	2899
7'0"	4877 x 2125	2369	2805	2661	3097	2951	2951

Intermediate sizes are available, please see your dealer for more details

Hörmann Sectional Doors

LPU 42 – double-skinned doors with steel sections – 42mm

Single doors with Z track tension springs giving low headroom as standard

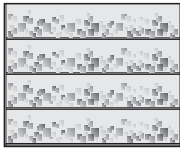
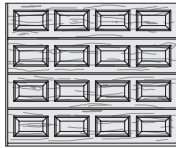
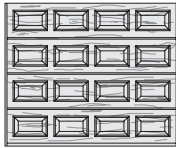

SINGLE DOORS										No. of panels
Door sizes BR		L-ribbed Planar		L-ribbed Duragrain		S-panelled Decograin		S-panelled Woodgrain		
Imperial	Metric	Outside White (1)	Outside Colour*	Outside Decor Coating*	Outside Timber Design*	Outside White	Outside Colour*			
6'10" x 6'2"	2080 x 1875	1226	1390	1489	1597	1223	1387	4		
6'6"	2080 x 2000	1258	1433	1527	1629	1281	1456	4		
6'10"	2080 x 2080	1277	1459	1545		1296	1478	4		
7'0" x 6'6"	2134 x 2000	1258	1438	1527	1629	1324	1504	4		
7'0"	2134 x 2125	1277	1468	1545	1651	1342	1533	4		
7'6" x 6'6"	2286 x 2000	1258	1451	1527	1629	1324	1517	4		
7'0"	2286 x 2125	1277	1482	1545	1651	1342	1547	4		
7'4"	2286 x 2250	1330	1547	1613	1798	1339	1556	4		
7'9"	2286 x 2375	1338	1567	1620	1840	1430	1659	4		
8'2"	2286 x 2500	1375	1616	1661	1905	1428	1669	4		
8'0" x 6'6"	2438 x 2000	1329	1534	1614	1729	1397	1602	4		
7'0"	2438 x 2125	1353	1571	1646	1752	1419	1637	4		
7'4"	2438 x 2250	1419	1650	1726	1976	1411	1642	4		
7'9"	2438 x 2375	1457	1701	1772	2006	1502	1746	4		
8'2"	2438 x 2500	1499	1755	1820	2043	1501	1757	4		
8'6" x 6'6"	2591 x 2000	1329	1547	1614	1729	1397	1615	4		
7'0"	2591 x 2125	1353	1585	1646	1752	1419	1651	4		
9'0" x 6'6"	2740 x 2000	1456	1687	1777	1896	1519	1750	4		
7'0"	2740 x 2125	1476	1721	1802	1928	1541	1786	4		
9'6" x 6'6"	2896 x 2000	1532	1776	1877	2000	1593	1837	5		
7'0"	2896 x 2125	1556	1815	1905	2036	1623	1882	5		
10'0" x 6'6"	3048 x 2000	1532	1789	1877	2000	1529	1786	5		
7'0"	3048 x 2125	1556	1829	1905	2036	1562	1835	5		

* For information on outside colour, see page 13. (1) Please Note CH 703 Planar Matt deluxe has a surcharge of £67 per m²

All coloured doors are special order only – 4 to 8 weeks delivery. Please note: the prices listed as Outside Colour are for the following RAL colours only: RAL 1015, 3003, 5011, 5014, 6005, 6009, 7016, 7030, 7035, 7040, 8001, 8003, 8028, 9005, 9006 and 9007. Special RAL colours are available, please ask your garage door specialist.

Double doors with N track springs (see shaded area of grid). For low headroom see bottom of page

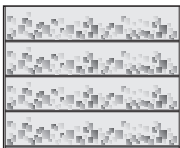
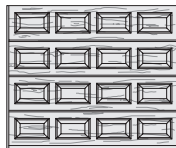
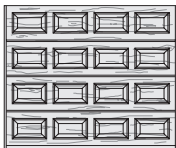
DOUBLE DOORS										No. of panels
Door sizes BR		L-ribbed Planar		L-ribbed Duragrain		S-panelled Decograin		S-panelled Woodgrain		
Imperial	Metric	Outside White (1)	Outside Colour*	Outside Decor Coating*	Outside Timber Design*	Outside White	Outside Colour*			
11'0" x 6'6"	3353 x 2000	1811	2093	2235	2377	1822	2104	5		
7'0"	3353 x 2125	1839	2139	2269	2417	1856	2156	5		
12'0" x 6'6"	3658 x 2000	2040	2348	2530	2687	2147	2455	6		
7'0"	3658 x 2125	2076	2403	2576	2733	2182	2509	6		
13'0" x 6'6"	3962 x 2000	2101	2434	2611	2773	2232	2565	6		
7'0"	3962 x 2125	2134	2488	2648	2814	2263	2617	6		
14'0" x 6'6"	4267 x 2000	2163	2522	2692	2857	2321	2680	7		
7'0"	4267 x 2125	2200	2581	2735	2902	2357	2738	7		
14'6" x 6'6"	4420 x 2000	2223	2595	2767	2934	2403	2775	7		
7'0"	4420 x 2125	2260	2655	2810	2982	2444	2839	7		
15'0" x 6'6"	4572 x 2000	2247	2632	2796	2969	2447	2832	7		
7'0"	4572 x 2125	2284	2693	2842	3015	2488	2897	7		
15'6" x 6'6"	4725 x 2000	2285	2682	2849	3028	2566	2963	7		
7'0"	4725 x 2125	2326	2748	2898	3073	2607	3029	7		
16'0" x 6'6"	4877 x 2000	2328	2738	2899	3082	2566	2976	7		
7'0"	4877 x 2125	2369	2805	2951	3133	2607	3043	7		

Low headroom

Door with track application L, torsion spring at the back

137

Intermediate sizes are available, please see your dealer for more details

Hörmann Sectional Doors



Optional extras for sectional doors

Colour surcharge	Price
RAL to choose colours (please ask to see colour chart)	per m ² 67
Door leaf in special colours (please ask to see colour chart)	per m ² 134

Fittings	Article no.	£
----------	-------------	---

The below listed handle sets are supplied with:

- Lock with profile half cylinder with side locking
- Template for lock knock-out on site

A factory lock knock-out will result in a longer delivery time and must be ordered explicitly (State position on order!)

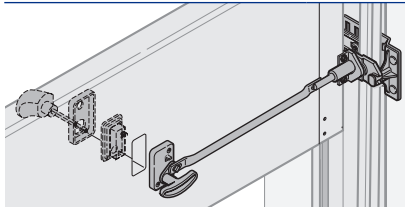

Door handle set, black plastic, prepared for profile cylinder	4015100	Each	62
Door handle set, cast aluminium RAL 9016, prepared for profile cylinder	3060831	Each	173
Door handle set, brown cast aluminium, prepared for profile cylinder	3076054	Each	173
Door handle set, brushed stainless steel, prepared for profile cylinder	3060835	Each	173

Emergency release	Article no.	£
-------------------	-------------	---

Emergency release for sectional doors with handle set (Please state at point of order)	Each	47
Emergency release for sectional doors without handle set (Please state at point of order)	Each	46

Special anchor set	Article no.	£
--------------------	-------------	---

Set of 8 special anchors for side frame fitting up to LZ = 5500 mm	3056482	per set 56
--	---------	-------------------

Reinforces the complete frame in difficult fitting situations

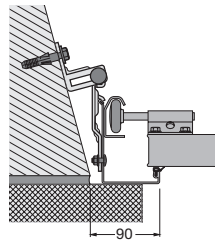

Unevenness can be accommodated without having to use packing or subframe

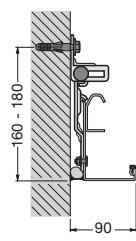

Fitting in the opening without additional posts
(Frame covering must also be ordered)

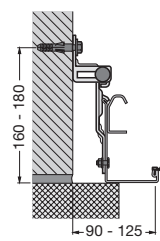

Fitting behind brickwork risk-free

Frame cover profiles matching the colour of the door – 55mm x 19.5mm and 90mm x 19.5mm: prices are per pair

Door heights	White RAL 9016								Colour							
	Woodgrain		Sandgrain		Planar		Silkgrain		Woodgrain		Sandgrain		Planar		Silkgrain	
	55mm	90mm	55mm	90mm	55mm	90mm	55mm	90mm	55mm	90mm	55mm	90mm	55mm	90mm	55mm	90mm
1875mm	59	83	64	90	64	90	64	90	72	107	87	113	87	113	87	113
2000mm	62	88	68	96	68	96	68	96	76	114	92	120	92	120	92	120
2080mm	65	92	71	100	71	100	71	100	80	119	96	125	96	125	96	125
2125mm	66	94	73	102	73	102	73	102	81	122	98	128	98	128	98	128
2250mm	70	99	77	108	77	108	77	108	86	129	104	135	104	135	104	135
2375mm	74	105	81	114	81	114	81	114	91	136	110	143	110	143	110	143
2500mm	78	110	85	120	85	120	85	120	95	143	115	150	115	150	115	150

Frame cover profiles matching the colour of the door – 55mm x 19.5mm and 90mm x 19.5mm: prices are per pair

Door heights	RAL to choose/CH 703				Planar CH703		Decograin/Titan Metallic CH 703		Duragrain	
	Woodgrain		Silkgrain		55mm	90mm	55mm	90mm	55mm	90mm
	55mm	90mm	55mm	90mm	55mm	90mm	55mm	90mm	55mm	90mm
1875mm	104	149	107	162	107	162	92	120	92	120
2000mm	110	158	114	172	114	172	98	128	98	128
2080mm	115	165	119	179	119	179	102	134	102	134
2125mm	117	168	122	183	122	183	105	136	105	136
2250mm	124	178	129	194	129	194	111	144	111	144
2375mm	131	188	136	205	136	205	117	152	117	152
2500mm	138	198	143	215	143	215	123	160	123	160

For all available colours and finishes please refer to page 13

Retrofit fascias

Door heights	White RAL 9016				Colour				RAL to choose/CH 703		Planar CH703	Decograin/Titan Metallic CH 703	Duragrain
	Woodgrain		Sandgrain		Woodgrain		Sandgrain		Woodgrain	Silkgrain			
	Woodgrain	Sandgrain	Planar	Silkgrain	Woodgrain	Sandgrain	Planar	Silkgrain	Woodgrain	Silkgrain			

Set: Renovation fascias to cover damaged brickwork edges consisting of: 3 angle sections, 69/40mm, each 3000mm long

Price	169	182	182	182	213	226	226	226	240	253	253	193	193
-------	-----	-----	-----	-----	-----	-----	-----	-----	-----	-----	-----	-----	-----

Set: Fascia frame -95- consisting of: 2 fascias, 95mm, 2800mm long, 1 fascia 95mm, 3200mm long, fixing material

Price	196	208	208	208	240	252	252	252	267	279	279	214	214
-------	-----	-----	-----	-----	-----	-----	-----	-----	-----	-----	-----	-----	-----

Hörmann Sectional Doors



Glazing options for sectional doors

LTE 42 with 3mm single pane in clear (FK) or crystal structure (KR), 3mm
 LTE 42 ribbed doors are only available with type D glazing
 LPU 42 with 16mm (for panelled) or 22mm (for ribbed) double pane in clear (DS) or crystal structure (DK)

LTE 42 panelled doors are available in S glazing only
 LTE 42 doors are not available with M0 & L0 glazing

Glazings			£/each
S0		With synthetic single pane, 3 mm, clear or crystal structure	LTE 42 100
		With synthetic double pane, 16 mm or 22mm, clear / clear or crystal structure / crystal structure	LPU 42 106
S1		With synthetic single pane, 3 mm, clear or crystal structure	LTE 42 120
		With synthetic double pane, 16 mm or 22mm, clear / clear or crystal structure / crystal structure	LPU 42 131
S2		With synthetic single pane, 3 mm, clear or crystal structure	LTE 42 120
		With synthetic double pane, 16 mm or 22mm, clear / clear or crystal structure / crystal structure	LPU 42 131
S 10 – S 60		With synthetic single pane, 3 mm, clear or crystal structure	LTE 42 127
		With synthetic double pane, 16 mm or 22mm, clear / clear or crystal structure / crystal structure	LPU 42 135
M0		<ul style="list-style-type: none"> With synthetic double pane, 22 mm, Clear / clear or crystal structure / crystal structure 	LPU 42 128

For door width and glazing configuration, please refer to the 01-20 A price list

L0		<ul style="list-style-type: none"> With synthetic double pane, 22 mm, Clear / clear or crystal structure / crystal structure 	LPU 42 167
-----------	--	--	-------------------

For door width and glazing configuration, please refer to the 01-20 A price list

Type D		<ul style="list-style-type: none"> With clear synthetic pane or crystal structure, 3 mm 	LTE 42 91
		<ul style="list-style-type: none"> With synthetic double pane, clear / clear or crystal structure / crystal structure, 16 mm 	LPU 42 106

For door width and glazing configuration, please refer to the 01-20 A price list

Sunrise Glazing			£/section
S 10		<ul style="list-style-type: none"> With synthetic single pane, 3 mm Clear or crystal structure 	For LTE 42 (4 x £127) 508
		<ul style="list-style-type: none"> With synthetic double pane, 16 mm or 22mm Clear / clear or crystal structure / crystal structure 	For LPU 42 (4 x £135) 540
S 20		<ul style="list-style-type: none"> With synthetic single pane, 3 mm Clear or crystal structure 	For LTE 42 (5 x £127) 635
		<ul style="list-style-type: none"> With synthetic double pane, 16 mm or 22mm Clear / clear or crystal structure / crystal structure 	For LPU 42 (5 x £135) 675
S 30		<ul style="list-style-type: none"> With synthetic double pane, 16 mm or 22mm Clear / clear or crystal structure / crystal structure 	For LPU 42 (6 x £135) 810
S 40		<ul style="list-style-type: none"> With synthetic double pane, 16 mm or 22mm Clear / clear or crystal structure / crystal structure 	For LPU 42 (7 x £135) 945
S 50		<ul style="list-style-type: none"> With synthetic double pane, 16 mm or 22mm Clear / clear or crystal structure / crystal structure 	For LPU 42 (8 x £135) 1080
S 60		<ul style="list-style-type: none"> With synthetic double pane, 16 mm or 22mm Clear / clear or crystal structure / crystal structure 	For LPU 42 (8 x £135) 1080

Standard Colour Surcharges for the above windows. Please note: front window frame only is painted		Price
Standard colour for Decograin/Duragrain/Planar	For glazing S0, S1, S2, M0, L0 & type D	Each 28
	For Sunrise glazing x No. of frames for width of door	Each 35
RAL to choose for Planar Matt deluxe CH 703	For glazing S0, S1, S2, M0, L0 & type D	Each 50
	For Sunrise glazing x No. of frames for width of door	Each 62

Roller garage door RollMatic

including operator

Size range and prices

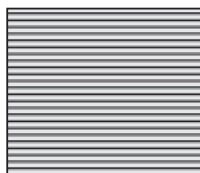

Exterior
Decopaint*

Golden Oak/Rosewood*
or Noir 2100 Sablé

* Painted in timber design look on inside and outside

Note:

Only the grey size ranges in the price grid may be used for external roller garage doors.

Prices for internal roller garage doors

Clear height (LH) = ordering size height (BMH)	Clear width (LB) = ordering size width (BMB)																						
	1000	1250	1500	1750	1900	2000	2250	2500	2750	3000	3250	3500	3750	4000	4250	4500	4750	5000	5250	5500	5750	6000	
3100						2137	2328	2403	2493	2569	2939	3054	3189	3268									
3000						2131	2323	2396	2487	2561	2929	3044	3179	3258									
2875						2125	2316	2389	2477	2553	2920	3034	3168	3245									
2750						2090	2219	2301	2400	2503	2830	2961	3077	3190									
2675	1880	1898	1981	1991	2087	2214	2296	2396	2498	2824	2953	3067	3183	3275	3353	3433	3511						
2625	1880	1896	1980	1989	2084	2211	2293	2392	2493	2820	2948	3063	3177	3270	3349	3428	3505						
2500	1876	1892	1974	1983	2014	2143	2226	2320	2396	2558	2836	2902	3025	3158	3237	3316	3393	3470	3547	3624	3699		
2375	1756	1772	1819	1826	1945	2102	2167	2224	2318	2468	2728	2841	2881	3046	3123	3204	3279	3356	3432	3506	3582		
2250	1753	1768	1814	1821	1939	2096	2159	2217	2309	2458	2716	2829	2870	3033	3109	3188	3265	3342	3419	3494	3572		
2125	1750	1762	1806	1816	1902	2031	2078	2143	2212	2336	2423	2732	2770	2942	3018	3095	3173	3250	3328	3406	3483		
2000	1746	1756	1801	1808	1832	1940	2016	2093	2134	2249	2328	2614	2686	2813	2887	2963	3040	3118	3196	3273	3350		
1800	1739	1751	1794	1800	1821	1929	2004	2081	2120	2234	2311	2595	2667	2793	2865	2940	3016	3093	3170	3246	3323		
1600																							

Only available in the priced size range listed! (Minimum production dimensions 1000 x 1600 mm)

Manually operated version of the roller garage door RollMatic (not possible with external roller garage doors) Price reduction **-218**

External roller garage door Surcharge **80**

Additional fascia panel
(Reinforcement of the fascia panel for fitting in the opening required) See page 23

Roller Garage Door RollMatic

Including operator

Size range and prices

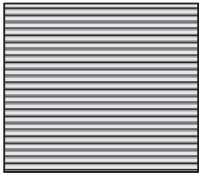
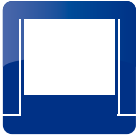

Exterior
Decograin *

Golden Oak or Rosewood

* Plastic film coating in timber design look on outside

Note:
External roller garage door not available with a Decograin surface!

Prices for internal roller garage doors

3100					2575	2816	2926	3055	3165	3598	3755	3933	4047								
3000					2561	2802	2912	3036	3146	3580	3732	3909	4022								
2875					2547	2783	2893	3015	3123	3554	3703	3878	3991								
2750					2500	2666	2783	2917	3054	3441	3608	3759	3911								
2675	2194	2235	2349	2376	2492	2655	2771	2905	3038	3425	3592	3744	3892	4015	4131	4239	4349				
2625	2188	2230	2344	2370	2485	2647	2763	2896	3030	3414	3581	3731	3879	4003	4118	4227	4336				
2500	2178	2219	2332	2355	2397	2563	2677	2803	2912	3110	3439	3536	3693	3862	3972	4083	4190	4298	4405	4513	4620
2375	2043	2080	2152	2174	2314	2507	2601	2687	2808	2998	3303	3450	3517	3721	3826	3936	4043	4149	4255	4360	4466
2250	2032	2068	2138	2159	2298	2490	2582	2664	2786	2971	3276	3420	3487	3686	3790	3898	4002	4107	4211	4314	4419
2125	2021	2055	2123	2144	2248	2409	2477	2571	2667	2821	2936	3295	3358	3566	3671	3773	3878	3982	4087	4190	4295
2000	2012	2043	2108	2129	2160	2299	2399	2505	2568	2711	2817	3150	3248	3405	3504	3607	3708	3810	3912	4014	4115
1800	1995	2024	2087	2104	2134	2271	2368	2470	2529	2670	2772	3103	3196	3350	3446	3546	3645	3745	3843	3943	4041
1600																					

Only available in the priced size range listed! (Minimum production dimension BR 1000 × 1600 mm)

Manually operated version of the roller garage door RollMatic (not possible with external roller garage doors) Price reduction **-218**

Additional fascia panel
(Reinforcement of the fascia panel for fitting in the opening required) see page 23

Optional Extras

For roller garage door RollMatic including operator



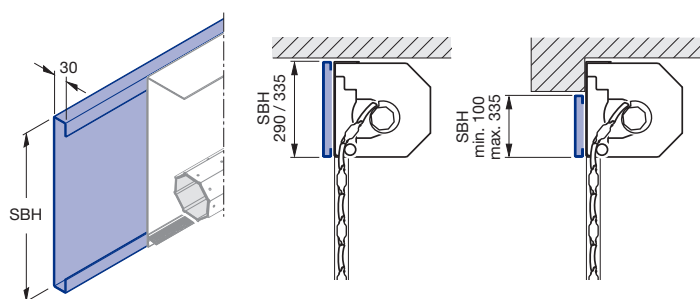

Fitting compensation set		Article no.	£
(to accommodate for unevenness on the building structure when fitting behind/in front of the opening)			
Fitting compensation set LH ≤ 2300		8991235 Per set	44
Fitting compensation set LH > 2300		8991236 Per set	50
Chamfered bottom profile			£
Roller garage door RollMatic with chamfered bottom profile (not available in the surfaces Golden Oak and Rosewood)		In black	Per m 332
		In door colour	Per m 332
Symmetrical barrel casing			£
Symmetrical barrel casing for a visually balanced look		Per door	No surcharge
Additional fascia panel			£
Reinforcement of the fascia panel			
Note: Required for fitting in the opening!		In door colour	Per m 68
► State additional fascia panel height (SBH) and width!			



Note:
State on door order, subsequent fitting is not possible.

SBH Fascia panel height
min. At least
max. Maximum

Optional extras			£
	Glazing element with clear synthetic pane, window cut-out 112 × 33 mm, black glazing frame on exterior, transparent on interior (maximum of 10 sections per door, number of glazing elements depending on the door width)	Per m	29
	Ventilation grilles Black plastic Ventilation cross section approx. 13 cm ² /grille (maximum of 10 sections per door, number of ventilation grilles depending on the door width)	Per m	29
	Brush seal for fascia panel	LB up to 3000 mm	Per door 15
		LB from 3000 mm to 5000 mm	Per door 22

Aluminium cover for side guides (as standard with external roller garage door) Per m 48

2-coloured roller garage door RollMatic			£
After technical clarification!			
2-coloured roller garage door – frame and door curtain		Per door	116
2-coloured door curtain		Per door	321

Accessories for operator RollMatic		Article no.	£
Motor connection line, 10 m		436523	36
Acoustic anti-lift kit		436524 Each	66
Emergency battery HINA 18		437726 Each	222
Emergency release			£
Exterior emergency release for internal roller garage door		436526 Each	107
Exterior emergency release for external roller garage door		436526 Each	107
Accessory bag for double secured release SE		437728 Each	9
Bowden cable, length 1 m, for double secured release SE		437986 Each	16
Note: All 3 articles are required for the external roller garage door!			





Fixed element			£
Element infill with roller garage door sections in RollMatic look. Position of sections does not match the roller garage door RollMatic.		Based on RAL 9016	
Frame made of aluminium extrusion profile. Coated in color of the element infill.		Color	458
Decopaint and Decograin colours matched to the surface Decopaint/Decograin.		Decopaint	
RAMB max. 6000 mm. Reinforcement profile from RAMB > 5000 mm.		Decograin	

RollMatic Side Doors

NT60 profile type 4

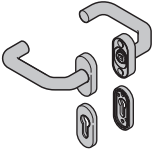
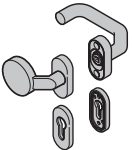
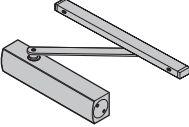
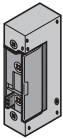
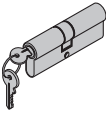

Accessories for RollMatic side doors

Matching side door and accessories			
Size Range Ordering sizes Overall frame dimensions (RAM) Width × Height	 White or Colour	 Decopaint Golden Oak or Rosewood	 Decograin Golden Oak or Rosewood
Opening inwards or outwards			
From 875 × 1800			
Up to 1200 × 2255	877	963	1112
From 1201 × 2256			
Up to 1284 × 2500	917	998	1162
Note: View of internal roller garage door / external roller garage door, state opening sense and handing!			
Glazing element			£
	Glazing element with clear synthetic pane, window cut-out 112 × 33 mm, black glazing frame on exterior, transparent on interior The number of glazing elements depends on the door width (not possible in the bottom section and in the lock area)		Per m 29
Ventilation grilles			£
	Ventilation grille, black plastic Ventilation cross section: approx. 13 cm ² /grille The number of ventilation grilles is dependent on the door width (not possible in the bottom section and in the lock area)		Per m 29
Smaller overall frame dimensions			£
Side door in smaller dimensions than special sizes			Per door 400
Fittings			£
Lever handle sets			
	Cast aluminium with natural finish (F1), prepared for profile cylinder		Each 115
	Cast aluminium in RAL 9016, prepared for profile cylinder		Each 166
	Cast aluminium in brown, prepared for profile cylinder		Each 166
	Brushed stainless steel, prepared for profile cylinder		Each 176
Lever / knob handle sets			
	Black plastic, prepared for profile cylinder		Each 63
	Cast aluminium in RAL 9016, prepared for profile cylinder		Each 166
	Cast aluminium in brown, prepared for profile cylinder		Each 166
	Brushed stainless steel, prepared for profile cylinder		Each 176
Overhead door closer			
	Overhead door closer with slide rail and hold-open device		Each 263
3-point locking			
	3-point locking with latch, bolt, and 2 locking hooks; keys to differ Cannot be retrofitted!		Per door 402
Electric door strike with day and night setting (without wiring). For doors with block frame made of aluminium profiles.			
	10–24 V, LH / RH hinged (only opens with an impulse, i.e. as long as the button is pressed)		Each 100
	10–24 V, LH / RH hinged (remains open after the impulse until the door is actuated, subsequent locking by door strike)		Each 133
Block reed contact			
	Block reed contact (article no. 4004810)		Each 98
Anti-panic locks			
Anti-panic lock function E			£
	For profile cylinders, for fixed knob on exterior, the door can only be opened from the outside using a key		Each 199
Profile double cylinder			
	Profile double cylinder 40 + 40 mm Keys to pass, for side doors NT 60		on request

Roller Garage Door – RollMatic TDL

Including tubular drive

Size range and prices



Prices for internal roller garage doors

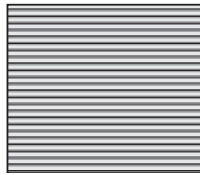

Exterior
White or Colour

2300	1349	1349	1380	1380	1489	1627	1675	1717	1792
2125	1349	1349	1380	1380	1442	1557	1624	1659	1720
2000	1349	1349	1380	1380	1397	1490	1553	1615	1643
1750	1349	1349	1380	1380	1397	1490	1553	1615	1643
1500	1349	1349	1380	1380	1397	1490	1553	1615	1643
	1250	1500	1750	1900	2000	2250	2500	2750	3050
Clear width (LB) = ordering size									

Only available in the priced size range listed! (Minimum production dimension BR 1250 x 1500 mm)

Prices for internal roller garage doors



Exterior
Decopaint Golden Oak*, Rosewood*
or Noir 2100 Sablé (Anthracite metallic)

2300	1416	1428	1473	1483	1597	1747	1810	1865	1956
2125	1409	1423	1468	1474	1541	1671	1747	1803	1873
2000	1406	1419	1463	1469	1490	1596	1670	1744	1785
1750	1399	1410	1451	1458	1479	1582	1654	1728	1766
1500	1392	1401	1442	1447	1467	1569	1640	1712	1748
	1250	1500	1750	1900	2000	2250	2500	2750	3050
Clear width (LB) = ordering size									

* Painted in timber design look on inside and outside

Only available in the priced size range listed! (Minimum production dimension BR 1250 x 1500 mm)

Surface Coating

Interior and exterior of door curtain:

- Standard colours based on the RAL colour chart:

- RAL 9016 Traffic white
- RAL 7016 Anthracite grey
- RAL 6005 Moss green
- RAL 9005 Jet black
- RAL 5011 Steel blue
- RAL 3003 Ruby red
- RAL 8028 Terra brown
- RAL 1015 Light Ivory
- RAL 7035 Light Grey
- RAL 9001 Cream
- RAL 9006 White aluminium

Accessory	Description	Part no.		£
	RollMatic TDL hand transmitter Impulse, Incl. battery 433.92 MHz Battery: 3 V / type: 2025 Dimensions (W x H x D): 28 x 58 x 25mm	RSC2	Each	50

Important product information

Please note that the RollMatic TDL cannot be fitted to a garage without alternate access.

Garage horizontal door RollMatic OD

including side operator ProMatic

Size range and prices



Exterior
White or Color

(same price)

Prices for garage horizontal doors RollMatic OD

Clear height (LH) = ordering size height (BMH)	3000			1933	1979	2033	2078	2129	2173	2226	
	2875			1896	1940	1981	2033	2082	2128	2170	
	2750			1862	1898	1941	1991	2036	2079	2120	
	2625			1821	1863	1897	1945	1992	2032	2070	
	2500	1610	1607	1806	1843	1885	1931	1979	2016	2058	
	2375	1570	1590	1703	1738	1781	1820	1860	1893	1933	
	2250	1532	1569	1609	1643	1681	1720	1754	1790	1827	
	2125	1504	1534	1570	1604	1638	1676	1710	1739	1779	
	2000	1473	1501	1531	1563	1596	1631	1664	1696	1730	
	1875	1440	1484	1497	1533	1569	1599	1634	1669	1703	
1700											
		1250	1500	1750	2000	2250	2500	2750	3000	3250	3500

Only available in the priced size range listed! (Minimum production dimensions 1250 x 1700 mm)

SupraMatic E, series 4



Optionally with garage door operator **SupraMatic E, series 4**
2 x 4-button hand transmitters HSE 4 BS, textured surface (black) with chrome caps

Surcharge

138

2-coloured garage horizontal door RollMatic OD

See page 29

Optional extras for garage horizontal door RollMatic OD

See page 29

Garage horizontal door RollMatic OD

including side operator ProMatic

Size range and prices

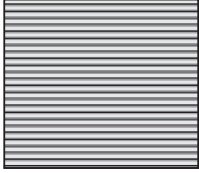

Exterior
Decopaint*

Golden Oak / Rosewood or
Noir 2100 Sablé

Prices for garage horizontal doors RollMatic OD

Clear height (LH) = ordering size height (BMH)	3000			2081	2146	2218	2281	2350	2413	2484
	2875			2038	2101	2158	2227	2295	2358	2418
	2750			1996	2052	2109	2177	2241	2298	2358
	2625			1950	2009	2059	2124	2187	2242	2295
	2500	1703	1715	1929	1982	2038	2100	2163	2219	2274
	2375	1659	1694	1821	1870	1927	1981	2036	2083	2139
	2250	1614	1667	1720	1768	1820	1873	1921	1970	2023
	2125	1582	1626	1676	1722	1771	1820	1867	1911	1963
	2000	1546	1588	1629	1675	1719	1765	1813	1856	1903
	1875	1508	1561	1586	1633	1680	1722	1768	1815	1858
1700										
	1250	1500	1750	2000	2250	2500	2750	3000	3250	3500

Only available in the priced size range listed! (Minimum production dimensions 1250 x 1700 mm)

SupraMatic E, series 4

£



Optionally with garage door operator SupraMatic E, series 4
2 x 4-button hand transmitters HSE 4 BS, textured surface (black) with chrome caps

Surcharge

138

Optional extras for garage horizontal door RollMatic OD

See page 29

Garage horizontal door RollMatic OD

including side operator ProMatic

Size range and prices



Exterior
Decograin*

Golden Oak or Rosewood

* Plastic film coating in timber design look on outside

Prices for garage horizontal doors RollMatic OD

Clear height (LH) = ordering size height (BM/H)	3000			2511	2624	2734	2831	2935	3064	3172	
	2875			2460	2568	2663	2765	2865	2992	3087	
	2750			2406	2500	2592	2695	2792	2910	3005	
	2625			2351	2446	2528	2627	2723	2836	2928	
	2500	2030	2073	2313	2402	2490	2582	2679	2770	2877	
	2375	1966	2027	2190	2276	2363	2443	2526	2613	2714	
	2250	1915	1992	2080	2162	2243	2321	2399	2483	2581	
	2125	1876	1941	2022	2100	2171	2247	2322	2396	2476	
	2000	1833	1895	1958	2034	2102	2177	2245	2316	2390	
	1875	1781	1856	1899	1974	2045	2111	2177	2251	2319	
1700											
		1250	1500	1750	2000	2250	2500	2750	3000	3250	3500

Only available in the priced size range listed! (Minimum production dimensions 1250 x 1700 mm)

SupraMatic E, series 4

£



Optionally with garage door operator SupraMatic E, series 4

2 x 4-button hand transmitters HSE 4 BS, textured surface (black) with chrome caps

Surcharge

138



Optional extras for garage horizontal door RollMatic OD

See page 29

Optional extras

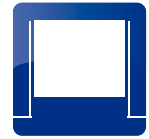
For garage horizontal door RollMatic OD including side operator ProMatic



Optional extras	Article no.	£
 <p>Glazing element With clear synthetic pane, window cut-out 112 x 33 mm, black glazing frame on exterior, transparent on interior (maximum 10 sections per door, number of glazing elements depending on the door width)</p>	Per m	29
 <p>Ventilation grilles Black plastic Ventilation cross section: approx. 13 cm²/grille (maximum of 10 sections per door, number of ventilation grilles depending on the door width)</p>	Per m	29

2-coloured garage horizontal door RollMatic OD	£
After technical clarification!	
2-coloured roller garage door – frame and door curtain	Per door 116
2-coloured door curtain	Per door 321

Retrofit fascia panels for flush fitting

Set: fascia frame OD

- As cover for lintel and frame with flush fitting and for renovations
- For use with doors up to LB max. 3150 mm and LH max. 2700 mm

Consisting of:

- 2 fascias, width 95 mm, length 2800 mm each,
- 1 fascia, width 95 mm, length 3200 mm,
- including additional fixing material for panel and door
- 2 plastic panel shoes (black)

Note:
The vertical tracks and the fascia panel are pre-drilled at the factory if this fitting is selected.

Surface finish	£
White, based on RAL 9016 or Color	Per set 258

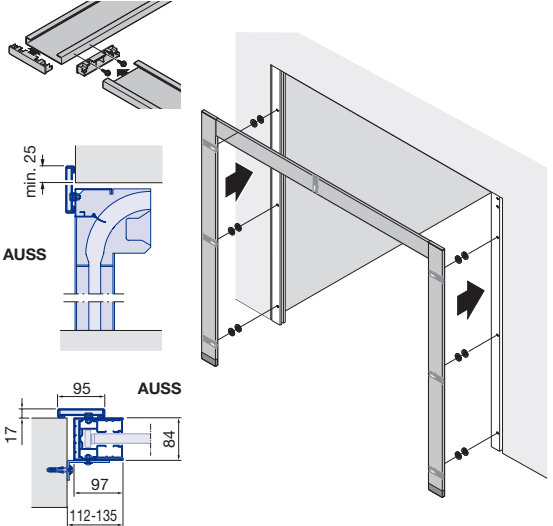

AUSS Exterior
min. Minimum

Emergency release NET 4 (required if there is no second entrance)	See the "Door operators" section in the 01-20 A
Accessories for operator ProMatic / SupraMatic E	See the "Door operators" section in the 01-20 A

Garage Door Operators

Operator Accessories



Garage door operators





Boom Length	SupraMatic E	SupraMatic P	ProMatic	ProMatic Canopy	ProMatic Akku
K	562	625	454	579	745
M	593	656	485	610	776
L	690	753	582	707	873

Hand transmitters with BiSecur technology are backwards compatible, i.e. they can also be used with series 1 and 2 operators (868 MHz). Hand transmitter 868 MHz BiSecur, incl. battery (Range of radio signal depends on local conditions)

- Possible
- Only in combination with a BiSecur radio receiver
- Only in conjunction with the BiSecur radio receiver ESE, status query possible
- Not possible

Garage door operators

SupraMatic E/P	SupraMatic HT	ProMatic	ProMatic Akku	RollMatic
----------------	---------------	----------	---------------	-----------

Accessory	Description	SupraMatic E/P	SupraMatic HT	ProMatic	ProMatic Akku	RollMatic
HS 1-button hand transmitter  Black HS 1 BS Art. no. 4511720 £ 66	Textured plastic surface with chrome-plated zinc die-cast caps <ul style="list-style-type: none"> • Impulse • Protection category: for dry rooms only • Temperature range: -20 °C to +60 °C • Battery: 1.5 V LR03/AAA • Dimensions: 38 × 95 × 16 mm 	●	●	●	●	●
HS 4-button hand transmitter  Black HS 4 BS Art. no. 4511724 £ 66	Textured plastic surface with chrome-plated zinc die-cast caps <ul style="list-style-type: none"> • Impulse • Protection category: for dry rooms only • Temperature range: -20 °C to +60 °C • Battery: 1.5 V LR03/AAA • Dimensions: 38 × 95 × 16 mm 	●	●	●	●	●
HS 5-button hand transmitter  Black HS 5 BS Art. no. 436946 £ 77	Textured plastic surface with chrome-plated zinc die-cast caps <ul style="list-style-type: none"> • Impulse • Status query • Protection category: for dry rooms only • Temperature range: -20 °C to +60 °C • Battery: 1.5 V LR03/AAA • Dimensions: 38 × 95 × 16 mm 	●	●	●	-	-
HS 5-button hand transmitter   Black White HS 5 BS HS 5 BS Art. no. 436752 436753 £ 77 77	High gloss plastic surface with chrome-plated zinc die-cast caps <ul style="list-style-type: none"> • Impulse • Status query • Protection category: for dry rooms only • Temperature range: -20 °C to +60 °C • Battery: 1.5 V LR03/AAA • Dimensions: 38 × 95 × 16 mm 	●	●	●	-	-

Garage Door Operators

Operator Accessories



Hand transmitters with BiSecur technology are backwards compatible, i.e. they can also be used with series 1 and 2 operators (868 MHz). Hand transmitter 868 MHz BiSecur, incl. battery (Range of radio signal depends on local conditions)

- Possible
- Only in combination with a BiSecur radio receiver
- Only in conjunction with the BiSecur radio receiver ESE, status query possible
- Not possible

Accessory			Description	Garage door operators																															
				SupraMatic E/P	SupraMatic HT	ProMatic	ProMatic Akku	RollMatic																											
Accessories For hand transmitters (HS and HSS) <div style="display: flex; justify-content: space-around; align-items: center; margin-top: 10px;"> <div style="text-align: center;">  Black </div> <div style="text-align: center;">  Black (textured surface) </div> <div style="text-align: center;">  White </div> </div>			<ul style="list-style-type: none"> For HS 1 BS, HS 4 BS, HS 5 BS, HSS 4 BS 																																
Hand transmitter station <table border="1" style="width: 100%; border-collapse: collapse; margin-top: 5px;"> <tr> <td>Art. no.</td> <td>436691</td> <td>437077</td> <td>436692</td> </tr> <tr> <td>£</td> <td style="color: blue;">12</td> <td style="color: blue;">12</td> <td style="color: blue;">12</td> </tr> </table>			Art. no.	436691	437077	436692	£	12	12	12																									
Art. no.	436691	437077	436692																																
£	12	12	12																																
For hand transmitters (HS and HSS) <div style="text-align: center; margin-top: 10px;">  </div>			<ul style="list-style-type: none"> For HSE 1 BS, HSE 2 BS and HSE 4 BS Transparent, incl. visor clip For wall fitting or for fitting to the visor clip Without fitting material 																																
Hand transmitter holder Transparent, incl. visor clip <table border="1" style="width: 100%; border-collapse: collapse; margin-top: 5px;"> <tr> <td>Art. no.</td> <td>436698</td> </tr> <tr> <td>£</td> <td style="color: blue;">11</td> </tr> </table>			Art. no.	436698	£	11																													
Art. no.	436698																																		
£	11																																		
HSE 1-button hand transmitter <div style="text-align: center; margin-top: 10px;">  </div>			Textured plastic surface with chrome-plated zinc die-cast caps <ul style="list-style-type: none"> Impulse Incl. key ring for fastening to the key chain Protection category: for dry rooms only Temperature range: 0 °C to +60 °C Battery: Lithium round cell 3 V / type CR 2032 Dimensions: 28 × 70 × 14 mm 	●	●	●	●	●																											
HSE 1 BS <table border="1" style="width: 100%; border-collapse: collapse; margin-top: 5px;"> <tr> <td>Art. no.</td> <td>4511728</td> </tr> <tr> <td>£</td> <td style="color: blue;">66</td> </tr> </table>			Art. no.	4511728	£	66																													
Art. no.	4511728																																		
£	66																																		
HSE 2-button hand transmitter <div style="display: flex; justify-content: space-around; align-items: center; margin-top: 10px;"> <div style="text-align: center;">  Black </div> <div style="text-align: center;">  White </div> </div>			High gloss plastic surface with chrome-plated zinc diecast caps <ul style="list-style-type: none"> Impulse Incl. key ring for fastening to the key chain Protection category: for dry rooms only Temperature range: 0 °C to +60 °C Battery: Lithium round cell 3 V / type CR 2032 Dimensions: 28 × 70 × 14 mm 																																
<table border="1" style="width: 100%; border-collapse: collapse; margin-top: 5px;"> <tr> <td>Art. no.</td> <td>436754</td> <td>436755</td> </tr> <tr> <td>£</td> <td style="color: blue;">66</td> <td style="color: blue;">66</td> </tr> </table>			Art. no.	436754	436755	£	66	66																											
Art. no.	436754	436755																																	
£	66	66																																	
HSE 2-button hand transmitter HSE 2 BS <table border="1" style="width: 100%; border-collapse: collapse; margin-top: 5px;"> <tr> <td>Housing colour</td> <td>Art. no.</td> <td>£</td> </tr> <tr> <td>Purple</td> <td>436869</td> <td style="color: blue;">77</td> </tr> <tr> <td>Orange</td> <td>436870</td> <td style="color: blue;">77</td> </tr> <tr> <td>Yellow</td> <td>436871</td> <td style="color: blue;">77</td> </tr> <tr> <td>Red</td> <td>436872</td> <td style="color: blue;">77</td> </tr> <tr> <td>Green</td> <td>436873</td> <td style="color: blue;">77</td> </tr> <tr> <td>Carbon</td> <td>436863</td> <td style="color: blue;">77</td> </tr> <tr> <td>Silver</td> <td>436864</td> <td style="color: blue;">77</td> </tr> <tr> <td>Dark rootwood look</td> <td>436866</td> <td style="color: blue;">77</td> </tr> </table>			Housing colour	Art. no.	£	Purple	436869	77	Orange	436870	77	Yellow	436871	77	Red	436872	77	Green	436873	77	Carbon	436863	77	Silver	436864	77	Dark rootwood look	436866	77		●	●	●	●	●
Housing colour	Art. no.	£																																	
Purple	436869	77																																	
Orange	436870	77																																	
Yellow	436871	77																																	
Red	436872	77																																	
Green	436873	77																																	
Carbon	436863	77																																	
Silver	436864	77																																	
Dark rootwood look	436866	77																																	







Garage Door Operators

Operator Accessories



Hand transmitters with BiSecur technology are backwards compatible, i.e. they can also be used with series 1 and 2 operators (868 MHz). Hand transmitter 868 MHz BiSecur, incl. battery (Range of radio signal depends on local conditions)

- Possible
- Only in combination with a BiSecur radio receiver
- Only in conjunction with the BiSecur radio receiver ESE, status query possible
- Not possible

Accessory		Description	Garage door operators				
			SupraMatic E/P	SupraMatic HT	ProMatic	ProMatic Akku	RollMatic
HSE 4-button hand transmitter  Black HSE 4 BS Art. no. 4511732 £ 66		Textured plastic surface with chrome-plated zinc die-cast caps <ul style="list-style-type: none"> • Impulse • Incl. key ring for fastening to the key chain • Protection category: for dry rooms only • Temperature range: 0 °C to +60 °C • Battery: Lithium round cell 3 V / type CR 2032 • Dimensions: 28 × 70 × 14 mm 	●	●	●	●	●
HSE 4-button hand transmitter  Black HSE 4 BS Art. no. 4511736 £ 59		Textured plastic surface with plastic caps <ul style="list-style-type: none"> • Impulse • Incl. key ring for fastening to the key chain • Protection category: for dry rooms only • Temperature range: 0 °C to +60 °C • Battery: Lithium round cell 3 V / type CR 2032 • Dimensions: 28 × 70 × 14 mm 	●	●	●	●	●
HSP 4-button hand transmitter  Black HSP 4 BS Art. no. 436776 £ 69		<ul style="list-style-type: none"> • Impulse • With sliding switch as a button lock-out • Incl. key ring • Protection category: for dry rooms only • Temperature range: -20 °C to +60 °C • Battery: Lithium round cell 3 V / type CR 2025 • Dimensions (D × H): Ø 48 × 13 mm 	●	●	●	●	●
HSD 2-button hand transmitter   Aluminium Chrome HSD 2-A BS HSD 2-C BS Art. no. 436774 436775 £ 93 93		<ul style="list-style-type: none"> • Impulse • High-quality metal housing • As a key ring • Protection category: for dry rooms only • Temperature range: 0 °C to +60 °C • Battery: Lithium round cell 3 V / type CR 2025 • Dimensions (W × H × D): 32 × 66 × 13 mm 	●	●	●	●	●
HSZ 1-button hand transmitter 2-button hand transmitter   Black Black HSZ 1 BS HSZ 2 BS Art. no. 436779 436782 £ 59 59		<ul style="list-style-type: none"> • Impulse • For insertion in a vehicle cigarette lighter • Protection category: for dry rooms only • Temperature range: -20 °C to +60 °C • Battery: Lithium 3 V / type CR 2 • Dimensions (D × H): Ø 29 × 39 mm 	●	●	●	●	●





Garage Door Operators

Operator Accessories



Hand transmitters with BiSecur technology are backwards compatible, i.e. they can also be used with series 1 and 2 operators (868 MHz). Hand transmitter 868 MHz BiSecur, incl. battery (Range of radio signal depends on local conditions)

- Possible
- Only in combination with a BiSecur radio receiver
- Only in conjunction with the BiSecur radio receiver ESE, status query possible
- Not possible

		Garage door operators				
		SupraMatic E/P	SupraMatic HT	ProMatic	ProMatic Akku	RollMatic
FIT 1-button radio internal push button 						
<ul style="list-style-type: none"> • Protection category: for dry rooms only • Temperature range: -20 °C to +60 °C • Battery: 2 × 1.5 V LR03 / AAA • Colour: Pure white RAL 9010 • Dimensions (W × H × D): 80 × 80 × 15 mm • Screw and adhesive fixing 		●	●	●	●	●
Art. no. FIT 1 BS 439740 £ 97						
FIT 4-button radio internal push button 						
<ul style="list-style-type: none"> • Impulse • Protection category: for dry rooms only • Temperature range: -20 °C to +60 °C • Battery: 2 × 1.5 V LR03 / AAA • Colour: Pure white RAL 9010 • Dimensions (W × H × D): 80 × 80 × 15 mm • Screw and adhesive fixing 		●	●	●	●	●
Art. no. FIT 4 BS 439741 £ 97						
FIT 5-button radio internal push button 						
<ul style="list-style-type: none"> • Impulse • Status query • Protection category: for dry rooms only • Temperature range: -20 °C to +60 °C • Battery: 2 × 1.5 V LR03 / AAA • Colour: Pure white RAL 9010 • Dimensions (W × H × D): 80 × 80 × 15 mm • Screw and adhesive fixing 		●	●	●	-	-
Art. no. FIT 5 BS 439742 £ 112						
FES Radio receiver electric socket 						
<ul style="list-style-type: none"> • To switch the light and further consumers on / off • Functions: Impulse, switching (On / Off), selective switching on or off, status feedback • Protection category: IP 20 • Standby: < 0.5 W • Temperature range: -20 °C to +35 °C • Operating voltage: 100 – 240 V AC • Electric socket switching capacity: <ul style="list-style-type: none"> - 2500 W / 10 A resistive load - 500 W inductive load • Colour: Pure white RAL 9010 • Dimensions (W × H × D): 80 × 80 × 67 mm 						
Art. no. FES 1 BS 439762 £ 104						
FES Radio receiver electric socket 						
<ul style="list-style-type: none"> • For Hörmann door operators and operators of other makes to switch lights and other consumers on and off • Functions: <ul style="list-style-type: none"> - Impulse, switching (On / Off), selective switching on or off, status feedback - Impulse for door operators (0.5 s), without operator status feedback • Protection category: IP 20 • Standby: < 0.5 W • Temperature range: -20 °C to +35 °C • Operating voltage: 100 – 240 V AC • Electric socket switching capacity: <ul style="list-style-type: none"> - 2500 W / 10 A resistive load - 500 W inductive load • Impulse output switching capacity: volt-free normally open contact max. <ul style="list-style-type: none"> • 24 V / max. 110 mA • With connection cable 1 × 2 m, 2-wire • Colour: Pure white RAL 9010 • Dimensions (W × H × D): 80 × 80 × 67 mm 						
Art. no. FES 1-1 BS 439763 £ 117						

Garage Door Operators





Operator Accessories



Hand transmitters with BiSecur technology are backwards compatible, i.e. they can also be used with series 1 and 2 operators (868 MHz). Hand transmitter 868 MHz BiSecur, incl. battery (Range of radio signal depends on local conditions)

- Possible
- Only in combination with a BiSecur radio receiver
- Only in conjunction with the BiSecur radio receiver ESE, status query possible
- Not possible

Radio internal push button 868 MHz BiSecur, incl. battery (Range of radio signal depends on local conditions)

		Garage door operators				
		SupraMatic E / P	SupraMatic HT	ProMatic	ProMatic Akku	RollMatic
FCT	Radio code switch					
						
	FCT 3-1 BS	●	●	●	●	●
Art. no.	4511856					
£	115					
	<ul style="list-style-type: none"> • Impulse • for control of up to 3 door operators • Illuminated keyboard • Activation on push of button • Protection category: IP 44 • Temperature range: -20 °C to +50 °C • Power supply: Battery 2 x 1.5 V LR03 / AAA • Housing: Plastic, colour Light grey RAL 7040 					
	FCT 3-1 BS (recessed):					
	• Dimensions (W x H x D): 80 x 80 x 15 mm					
	FCT 3-1 BS (surface-mounted):					
	• Dimensions (W x H x D): 80 x 80 x 30 mm					
FCT	Radio code switch					
						
	FCT 10-1 BS	●	●	●	●	●
Art. no.	4511861					
£	172					
	<ul style="list-style-type: none"> • Impulse • for control of up to 10 door operators • Illuminated keyboard, hinged lid • Automatic activation on opening the lid or by pushing the button • Protection category: IP 44 • Temperature range: -20 °C to +50 °C • Power supply: Battery 2 x 1.5 V LR03 / AAA • Housing: Plastic, painted, colour White aluminium RAL 9006 					
	FCT 10-1 BS (recessed):					
	• Dimensions (W x H x D): 80 x 80 x 20 mm					
	FCT 10-1 BS (surface-mounted):					
	• Dimensions (W x H x D): 80 x 80 x 35 mm					
CTR	Code switch					
						
	1 relay output 3 separate relay outputs					
	CTR 1b-1 CTR 3b-1	●	●	●	-	●
Art. no.	4511631 4511632					
£	211 243					
	<ul style="list-style-type: none"> • Impulse • Illuminated keyboard • With 5 m connecting cable between the input unit and the decoder • Operating voltage: optionally 100–240 V AC or 10–24 V AC/DC • Max. switching capacity: <ul style="list-style-type: none"> - 30 V DC / 2.5 A (resistive load) - 230 V AC/500 W (resistive load) • Protection category: <ul style="list-style-type: none"> - Input unit IP 65 - Decoder unit IP20 • Temperature range: -20 °C to +60 °C • Input unit dimensions (W x H x D): 80 x 80 x 15 mm • Decoder unit dimensions (W x H x D): 140 x 130 x 50 mm • Without connecting lead, connection cables for power supply <ul style="list-style-type: none"> - 230 V AC: Use connection cable ZL 1 - 24 V AC / DC and for providing impulse to operator: Use ASL connection cables (see page 521 in 01 -19 A Price List) 					
	CTR 1b-1: 1 relay output for control of one door operator					
	CTR 3b-1: 3 separate relay outputs for control of 2 operators, second opening height, outdoor lighting					
CTP	Code switch					
						
	3 separate relay outputs					
	CTP 3-1	●	●	●	-	●
Art. no.	4511634					
£	289					
	<ul style="list-style-type: none"> • Illuminated capacitive keyboard • Impulse • With 5 m connecting cable between the input unit and the decoder • Operating voltage: optionally 100–240 V AC or 10–24 V AC/DC • Max. switching capacity: <ul style="list-style-type: none"> - 30 V DC / 2.5 A (resistive load) - 230 V AC/500 W (resistive load) • 3 separate relay outputs for control of 2 operators, second opening height, outdoor lighting • Protection category: <ul style="list-style-type: none"> - Input unit IP 65 - Decoder unit IP20 • Temperature range: -20 °C to +60 °C • Input unit dimensions (W x H x D): 80 x 80 x 15 mm • Decoder unit dimensions (W x H x D): 140 x 130 x 50 mm • Without mains lead, connection cables for power supply <ul style="list-style-type: none"> - 230 V AC: Use connection cable ZL 1 (see page 520) - 24 V AC / DC and for providing impulse to operator: Use ASL connecting leads 					





Garage Door Operators

Operator Accessories



Hand transmitters with BiSecur technology are backwards compatible, i.e. they can also be used with series 1 and 2 operators (868 MHz). Hand transmitter 868 MHz BiSecur, incl. battery (Range of radio signal depends on local conditions)

- Possible
- Only in combination with a BiSecur radio receiver
- Only in conjunction with the BiSecur radio receiver ESE, status query possible
- Not possible

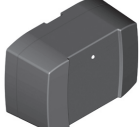
		Garage door operators				
		SupraMatic E/P	SupraMatic HT	ProMatic	ProMatic Akku	RollMatic
Radio internal push button 868 MHz BiSecur, incl. battery (Range of radio signal depends on local conditions)						
FIT	Radio internal push button	<ul style="list-style-type: none"> ● Impulse ● With 2 impulse push buttons for control of 2 operators via radio signal ● One additional button for On/Off function of connected external control elements ● Connection option for max. 2 control elements (voltage-free contact) e.g. key switch ● Protection category: for dry rooms only ● Temperature range: -20°C to +60°C ● Battery: 2 x 1.5 V LR03/AAA ● Colour: Pure white RAL 9010 ● Dimensions (W x H x D): 80 x 80 x 45 mm 				
		●	●	●	●	●
	FIT 2-1 BS					
Art. no.	4511695					
£	86					
IT 3b-1	Internal push button	<ul style="list-style-type: none"> ● Impulse ● Additional buttons for light on/off and operator on/off (vacation mode) ● Illuminated keyboard ● With 7 m connection cable, 2-wire ● Protection category: for dry rooms only ● Temperature range: -20°C to +60°C ● Colour: Pure white RAL 9010 ● Dimensions (W x H x D): 80 x 80 x 45 mm 				
		●	●	-	-	-
	IT 3b-1					
Art. no.	4511647					
£	45					
Radio finger-scan 868 MHz BiSecur (range of radio signal depends on local conditions!)						
FFL	Radio finger-scan	<ul style="list-style-type: none"> ● Impulse ● To control up to 2 door operators using a fingerprint ● Up to 25 fingerprints can be taught in, cannot be individually deleted ● Hinged lid ● Automatic activation on opening the lid or by pushing the "ON" button ● Protection category: IP 44 ● Temperature range: -20°C to +50°C ● Power supply: Battery 2 x 1.5 V LR03 / AAA ● Housing: Plastic, painted, colour White aluminium RAL 9006 				
		●	●	●	●	●
	FFL 25 BS					
Art. no.	4511870					
£	227					
	FFL 25 BS (recessed):					
	● Dimensions (W x H x D): 80 x 80 x 20 mm					
	FFL 25 BS (surface-mounted):					
	● Dimensions (W x H x D): 80 x 80 x 35 mm					
Batteries		Description				
HNA	Emergency battery	<ul style="list-style-type: none"> ● Emergency power supply to bypass power failures up to 18 hours and max. 5 door cycles (depending on temperatures, situation of charge etc.) ● To be fixed on operator or garage ceiling ● Protection category: for dry rooms only ● Weight: approx: 2.3 kg ● Operating voltage: 24 V DC / 2.3 Ah ● Dimensions (W x H x D): 150 x 70 x 90 mm <p>Also suitable for series 2 SupraMatic and ProMatic operators.</p>				
		●	●	●	-	●
	HNA 18-3					
Art. no.	437726					
£	222					
HNA	Emergency battery	<ul style="list-style-type: none"> ● Emergency power supply to bridge power outages ● Universal fixing for wall and floor fitting ● Double LED function display ● Protection category: IP 65 ● Weight: approx: 3 kg ● Dimensions: 213 x 143 x 96 mm ● Battery voltage: 24 V DC / 2.3 Ah <p>For RotaMatic / P / PL from autumn 2010 and for LineaMatic / P / H from year of manufacture 10 / 2009.</p>				
		-	-	-	-	-
	HNA Outdoor					
Art. no.	436522					
£	235					

Warranty

Hörmann products are manufactured to the highest quality standards and leave our factory only after rigorous quality testing. However, if you should have grounds for complaint, this section tells you what our door warranty offers, and how to go about making your claim.

In the unlikely event of a warranty claim becoming necessary, please contact the dealer or distributor who originally supplied your garage door. Your dealer should then supply details of the claim, together with a copy of the warranty card provided with the door and proof of purchase to the Product Services Department at Hörmann (UK) Ltd. To enable your claim under warranty to be processed as quickly as possible, you should provide the following details:

1. Your name, address and telephone number
2. Original invoice with date of purchase
3. Product description/door type and product number
4. Description of defect

An assessment of the claim will then be made. This may require Hörmann to inspect the product in-situ. In the event that there is no legitimate warranty claim under the terms specified herein, you may be liable for the costs of the inspection visit. We strongly recommend that you take note of the care and usage instructions displayed on the stickers on the back of your garage door, and on the page opposite, and that you follow these instructions throughout.

Hörmann installers

Hörmann (UK) Ltd has a nationwide network of recommended installers who will be able to offer you a regular maintenance service on your garage door. Please call us on 01530 513050 for details of your nearest dealer.

Hörmann (UK) Ltd Garage Door Warranty

Warranty Period	The purchaser is granted a warranty covering the safe and reliable function of the Hörmann garage door for a period of 10 years from the date of purchase. A 5 year warranty applies to springs, wire cables, track rollers, hinges and guide rollers. The warranty period for replacement parts is 6 months or to the end of the current warranty period, whichever is longer. In the case of foil-coated timber-effect, a warranty of 5 years is granted, for timber a warranty of 2 years is granted on the door panels alone under the terms and conditions specified herein. The door mechanism and steel frame (if applicable) is covered by the 10 year warranty period.
Requirements	Warranty claims are only applicable in the country where the garage door was purchased. The product must have been purchased through our authorised distribution channels. The warranty only covers damage to the contract object. The fully completed warranty card together with the receipt of purchase correspondingly dated substantiates your right to claim under the warranty. During the warranty period we undertake to rectify any and all defects to the Hörmann product which can be proved to be attributed to a material or manufacturing fault. We pledge at our discretion either to exchange the defective merchandise for faultless merchandise, repair it or allow a reduction in price. We do not accept costs for dismantling and installation nor for carriage. Replaced parts become our property.
Performance	The warranty does not cover damage caused through: <ul style="list-style-type: none">• normal wear and tear• improper installation• negligent care and maintenance• improper initial and subsequent operation• negligent or wanton destruction• external influences such as fire, water, salts, alkaline solutions, acids, abnormal environmental influences• mechanical damage through improper transport and fitting• priming and other surface protection treatments• incorrect or too late applied surface protection treatments• repair by non-qualified persons• using non-Hörmann parts without the approval of the manufacturer• removal of the product number or making it unidentifiable

Electric Operator Warranty

A separate 5 year warranty is granted on our electric operators. This includes operator mechanics, motor and motor control systems. A 2 year warranty is granted on radio equipment, accessories and system controls. There is no warranty on consumables (e.g. fuses, batteries, bulbs etc.). For further details please contact us on 01530 513030 or through our website on www.hormann.co.uk

User Information/Care

Finish – Steel Doors

The coating process applied to the door and chassis is environmentally friendly. Minor scratches or marks are not covered under the conditions of our warranty and should be repaired immediately to prevent corrosion and deterioration of the panel. Corrosive substances such as acids, alkalines, and salts, etc. should be cleaned from the door immediately; failure to do so will result in deterioration of the finish, which will not be covered under our warranty. Should deterioration of the finish start to occur you will need to repaint your door immediately. Prepare the surface lightly with wet and dry. Then treat with solvent based 2 pack epoxy wash primer and a normal commercial paint (cellulose paint must not be used). Hörmann steel doors are a finished product. They do not require re-painting on site. They are however not immune to damage, which can occur at any stage of the handling of the product from factory to site.

Finish – Timber Doors

Timber panels are coated with a neutralising base-stain. Doors must be stored upright, under cover, with wrapping intact, until wrapping is removed. As soon as the door is unwrapped, one coat of a good quality basecoat primer must be applied to both sides of the door. Immediately after installation, your timber doors require a further two coats of a good quality exterior wood finish on both sides. Initial application and periodic treatment should be carried out strictly in accordance with the woodstain manufacturer's instructions. Failure to follow these instructions will result in early deterioration of the timber panel.

Paint Finish – Steel Doors

Minor surface damage can easily be repaired using touch up sprays or sticks without invalidating warranties.

Extracts from DHF consumer advice



The following document was designed by the Association of Garage Door Specialists, updated by the DHF and endorsed by all major UK garage door manufacturers, as a guide for purchasers of domestic garage doors.

Visual appearance of Garage Doors

A new garage door can be a significant investment that will transform the appearance of your home. This information is a guide to the quality you can expect.

The Quality Check

The quality check should be carried out in natural daylight, not direct sunlight. Stand at a distance of 3 metres from the door to view the overall appearance. The door is acceptable if, taking into account the facts below, none of the following are readily visible on the face of the door:

- Marks or distortion associated with the manufacturing process
- Minor indentations, marks or scuffs on the surface
- Paint or stain blemishes

The Facts

Steel Doors

Panel Distortion The rolling or pressing of steel panels during manufacture will cause distortion in the steel and while every effort is made to keep this to a minimum, inevitably some visible distortion will remain. The application of high gloss paints will make this slight distortion more apparent, especially under certain lighting conditions, such as car headlamps, or bright sunshine.

Paint Finish Primed doors – the primer coating is applied as a base coat only and as such requires additional finishing with a good quality exterior paint. Any marks or scratches on the primer coat should be rubbed down and repainted as part of this finishing process.

Timber Doors Finished doors – the factory application of the paint finish is an automated process and this may result in minor blemishes or slight inconsistencies in the paint, particularly in the area of panel joints.

Timber

Timber is a natural product and there will be variations in pattern, colour, shading and grains. No two doors will be the same, because wood naturally expands and contracts according to environmental conditions, joints will open and close and some minor curvature may occur.

It is vital that timber doors are fully finished as per the manufacturers instructions before exposure to the elements.

All Doors

Colour Match Pairs of doors should be ordered together to obtain the best colour match, bearing in mind the limitations of the materials used in the construction. Timber garage doors cannot be ordered as matching sets.

Size Variation As the size of a door changes in height and/or width, the panel frequency and profile can change, therefore doors of the same style but of different sizes can be significantly different in appearance.

Clearances All doors require operating clearances, i.e. the gap between the door panel and the frame opening, these are inbuilt during manufacture and should not be reduced by means of infills, or draughtproofing.

Deflection When in the open position, all doors will display a level of vertical deflection or “sag” across the width of the panel. Individual manufacturers' specifications should be consulted for exact tolerances.

Power Operated Garage Doors

It is against the law to install a power operated garage door in the UK without complying with the Machinery Directive.

To comply with the Machinery Directive both the door and the operator used in the installation must have a Declaration of Incorporation from the manufacturer.

On completion of the installation the installer must provide a Declaration of Conformity and apply a CE mark giving details of the installation to the door / operator combination, which is now classed as a machine.

The installer must issue to the customer a Declaration of Conformity on completion of the installation.

The installer must hold copies of both the Declaration of Incorporation and the Declaration of Conformity on a technical file for inspection by the relevant authorities.

If any of the above requirements are not fulfilled the installation is illegal.

Please ensure for your own safety and peace of mind that whoever installs your electric operator is both willing and able to fulfil these requirements; if they are not – do not use them!

Members of the DHF Garage Door Installer Group can and will install your Hörmann operator safely and legally.

Since the company's policy is one of continuous improvement of its products, we reserve the right to make any alterations in design, manufacture or price. All business is governed by the company's Standard Conditions and this document does not form any part of any contract with the company and statements contained in it should not be construed as representations or warranties.

Hörmann: Quality without Compromise



Hörmann KG Amshausen, Germany



Hörmann KG Antriebstechnik, Germany



Hörmann KG Brandis, Germany



Hörmann KG Brockhagen, Germany



Hörmann KG Dissen, Germany



Hörmann KG Eckelhausen, Germany



Hörmann KG Freisen, Germany



Hörmann KG Ichttershausen, Germany



Hörmann KG Werne, Germany



Hörmann Alkmaar B.V., Netherlands



Hörmann Legnica Sp. z o.o., Poland



Hörmann Beijing, China



Hörmann Tianjin, China



Hörmann LLC, Montgomery IL, USA



Hörmann Flexon LLC, Burgettstown PA, USA



Shakti Hörmann Ltd., India

Hörmann is the only manufacturer worldwide that offers you a complete range of all major building products from one source. We manufacture in highly-specialised factories using the latest production technologies. The close-meshed network of sales and service companies throughout Europe, and activities in the USA and Asia, make Hörmann your strong partner for first-class building products, offering “Quality without Compromise”.

GARAGE DOORS

OPERATORS

INDUSTRIAL DOORS

LOADING EQUIPMENT

HINGED DOORS

DOOR FRAMES

Hörmann (UK) Ltd
Gee Road
Coalville
Leicestershire
LE67 4JW

Tel: 01530 513000
Fax: 01530 513001

www.hormann.co.uk

HÖRMANN